



2005



Anmerkungen

D

Diese Anwendungsliste dient nur der Typenauswahl.

Mit Veröffentlichung dieser Ausgabe verlieren alle vorhergehenden Anwendungslisten ihre Gültigkeit.

Ein Rechtsanspruch kann aus dem Inhalt nicht begründet werden.

Empfehlungen gemäß der FAA-Richtlinien für Luftfahrttriebwerke sind in dieser Ausgabe nicht enthalten.

Die im Katalog aufgeführten Zündkerzen, Glühkerzen, Stecker können in den Motoren entsprechend unserer Katalogempfehlung verwendet werden. Erkennbarer Irrtum sowie offensichtliche Druckfehler unterliegen der Sorgfaltspflicht des Anwenders. Für die Fehlerfreiheit und die zugesagten Eigenschaften leistet NGK Gewähr entsprechend dem jeweiligen Stand der Technik. Grundvoraussetzung dafür ist die sachgemäße Handhabung der NGK-Produkte. Die Gewährleistungspflicht für Materialfehler oder mangelhafte Ausführung beträgt 24 Monate ab Kaufdatum, sofern die vom Fahrzeughersteller vorgeschriebenen Wechselintervalle nicht betroffen sind. Ausgenommen davon ist der normale Verschleiß sowie jeglicher Racingeinsatz.

Comments:

GB

This application list is only valid for type identification.

This catalogue supersedes all previous catalogues.

We do not accept any responsibility in respect of legal claims arising out of the contents of this list.

Spark Plug recommendations regarding FAA guidelines for aeroplane power units are not included in this edition.

The spark plugs, glow plugs, and caps listed in our Catalogue can be used in the engines which we recommend in our catalogue. Recognizable mistakes, such as printing errors are subject to careful scrutiny by the user. NGK safeguards for accuracy and the mentioned characteristics in accordance with the current state of the art technology. Basic condition for this is the proper use of the NGK product. The seller's warranty period for faults in material or unsatisfactory performance is 24 months from the date of purchase, provided the prescribed interval changes from the vehicle manufacturer are adhered to. Excluded from this is normal wear and tear and any form of racing activities.

Informations:

F

Ce catalogue doit être utilisé en tant que manuel de référence. Des bougies d'allumage plus froides ou plus chaudes devront être utilisées selon le style de conduite et l'usure du moteur.

La dernière version du guide NGK doit être consultée à tout moment, étant donné qu'elle contient les plus récentes caractéristiques de bougies et de moteurs.

Ce catalogue ne concerne pas les moteurs qui équipent les avions.

Les bougies d'allumage, bougies de préchauffage, embouts, mentionnés dans notre catalogue peuvent être utilisés dans les moteurs selon notre recommandation. Des erreurs reconnaissables, ainsi que des erreurs évidentes d'impression sont sous la propre responsabilité de l'utilisateur. NGK se porte garant quant au soin dans l'exécution ainsi que pour les qualités effectives correspondant à l'état respectif de la technique. La condition de base requise est une manipulation objective et correcte des produits NGK. Le délai de la garantie pour les défauts d'usinage ou d'usinage imparfait est de 24 mois à partir de la date d'achat, pour autant que les intervalles de services prescrits par le fabricant d'automobile ne soient pas mis en cause. Est également exclu de la garantie, l'usure normale, ainsi que toute application dans le domaine de la course automobile.

Opmerkingen: **NL**

Deze catalogus geldt alleen voor het uitzoeken van bougiereferenties.

Bij publicatie van deze uitgave komen alle vorige catalogi te vervallen.

Wettige aanspraak volgens FAA richtlijnen voor vliegtuigmotoren is in deze uitgave niet opgenomen.

The spark plugs, glow plugs, and caps listed in our Catalogue can be used in the engines which we recommend in our catalogue. Recognizable mistakes, such as printing errors are subject to careful scrutiny by the user. NGK safeguards for accuracy and the mentioned characteristics in accordance with the current state of the art technology. Basic condition for this is the proper use of the NGK product. The seller's warranty period for faults in material or unsatisfactory performance is 24 months from the date of purchase, provided the prescribed interval changes from the vehicle manufacturer are adhered to. Excluded from this is normal wear and tear and any form of racing activities.

Comentarios: **E**

Esta lista de aplicaciones es solamente válida para la identificación de los tipos.

Consulte siempre la última lista de aplicaciones.

No nos responsabilizamos de casos de aplicaciones que no estén incluidas en esta lista.

En esta edición no están incluidas las aplicaciones de bujías para motores FAA de aviación.

Las bujías de encendido, calentadores diesel y pipas de bujía que aparecen en nuestro Catálogo pueden utilizarse en aquellos motores que recomendamos en el mismo. Los errores reconocibles, como los de impresión, están sujetos a un reconocimiento exhaustivo por parte del usuario. NGK vela por la precisión y las características mencionadas de acuerdo con la tecnología de última generación. Una condición básica para ello es la correcta utilización del producto NGK. El período de garantía del vendedor en relación con defectos de material o rendimiento insatisfactorio es de 24 meses a partir de la fecha de compra, siempre y cuando se observen los cambios de intervalo prescritos por parte del fabricante del vehículo. Quedan excluidos de este punto el desgaste normal y cualquier forma de actividades deportivas.

Comentários: **P**

Esta lista de aplicações é válida apenas para a identificação de tipos.

Este catálogo substitui todos os anteriores catálogos.

Não nos responsabilizamos pelos casos de aplicações que não estejam contidos nesta lista.

Nesta edição não estão incluídas as aplicações de velas de ignição para motores FAA de aviação.

As velas de ignição, velas de resistência eléctrica, e cachimbos apresentados no nosso Catálogo podem ser utilizados nos motores recomendados no próprio documento. Erros reconhecíveis, como gralhas, deverão estar sujeitos a cuidadoso escrutínio pelo utilizador. NGK garante a exactidão e as características mencionadas de acordo com a actual tecnologia de ponta. Uma condição básica para isso é a utilização correcta dos produtos NGK. O período de garantia do vendedor para defeitos no material ou performance insatisfatória é de 24 meses a contar da data de venda, sempre que se tenham respeitado os intervalos de mudança prescritos pelo fabricante do veículo. Desta garantia encontra-se excluído o desgaste normal do produto e qualquer forma de actividade competitiva.

Importante:

I

Questo catalogo deve essere utilizzato come indicazione generica. Differenti condizioni di guida possono richiedere candele più fredde.

Questa edizione annulla quelle precedenti.

Non si assume alcuna responsabilità causata o derivata dal presente catalogo.

Le applicazioni di questo catalogo non devono essere riferite a motori installati su velivoli.

Le candele di qualsiasi genere, ed i cavi elettrici notati nel catalogo, possono essere inseriti nei motori da noi consigliati. Errori evidenti, o errori nel catalogo, devono essere controllati da colui che fa uso di questi pezzi. Per la correttezza delle informazioni ed attributi, la NGK garantisce nello standard tecnico di loro conoscenza. Requisito unico, è l'uso corretto delle informazioni tecniche. Il periodo di risarcimento è di 24 mesi a partire dall'acquisto. Questo verrà eseguito per materiale errato, fremo restando che i periodi d'intervallo non vengano toccati. Esclusi sono il normale consumo delle candele ed i kit Racing.

Kommentarer:

DK

Denne anvendelsesliste kan kun bruges til type-identifikation.

Kun denne anvendelsesliste er gældende.

Der kan ikke gøres juridiske krav gældende på baggrund af denne liste.

Anbefalinger af tændrør til flymotorer i henhold til FAA retningslinjer er ikke indeholdt i denne udgave.

De tændrør, gløderør og tændrørshætter, der er anført i vort katalog, kan monteres i de motorer, som anbefales i kataloget. Tydelige fejl som f.eks. trykfejl bør nøje undersøges af brugeren. NGK garanterer for nøjagtighed, og at de nævnte egenskaber er i overensstemmelse med den nyeste, teknologiske udvikling. Den grundlæggende forudsætning herfor er korrekt brug af NGK's produkter. Garantien for fejl i materialer eller for utilfredstillende udførelse gælder i 24 måneder fra købsdato, forudsat at producentens foreskrevne udskiftningsintervaller er overholdt. Undtaget er normal slitage og enhver form for racing aktiviteter.

Kommentarer:

N

Opplysningene i katalogen kan bare brukes til typeidentifikasjon.

Denne katalogen erstatter alle tidligere utgaver.

Innholdet i denne listen er ikke juridisk bindende.

Tennplugganbefalinger i forbindelse med FAA-retningslinjer for flymotorer er ikke tatt med i denne utgaven.

De tennplugger, glødeplugger og pluggetter som vises i katalogen, kan benyttes i motorer i henhold til de anbefalinger som gis i katalogen. Gjenkjennelige feil, slik som åpenbare trykkfeil, er underlagt brukerens undersøkelsesplikt. NGK garanterer for feilfrihet og de egenskaper som beskrives i henhold til gjeldende teknologisk standard. Forutsetningen for dette er at NGK produktet benyttes på en korrekt måte. Garantiperioden for materialfeil eller feilkonstruksjon løper i 24 måneder fra kjøpsdato, så lenge dette ikke kommer i konflikt med bytteintervallene som kjøretøysprodusenten opererer med. Unntatt fra dette er normal slitasje så vel som racingbruk.

Huomioitavaa: **FIN**

Tämän luettelon suositukset koskevat vain tyyppiltään tunnistettavia moottoreita. Tämä luettelo kumoaa ja korvaa kaikki aikaisemmat luettelot. Emme vastaa minkäänlaisista tämän luettelon julkaisemisesta johtuvista korvausvaatimuksista. Tässä luettelossa olevat sytytystulppasuositukset eivät koske lentokoneisiin asennettuja FAA:n hyväksymiä lentokonemoottoreita.

Luettelossa mainittuja sytytystulppia, hehkutulppia ja tulpan liittimiä voidaan käyttää vain moottoreissa, joita luettelon suositukset koskevat. Luettelon käyttäjän tulee noudattaa huolellisuutta ja kiinnittää huomiota havaittavissa oleviin, mahdollisiin virheisiin kuten painovirheisiin. NGK takaa tarkkuuden ja mainittujen ominaisuuksien yhdenmukaisuuden nykyisen, ajanmukaisen tuotantoteknologian mahdollistamalla tavalla. Perusedellytyksenä tälle on NGK-tuotteen oikea käyttö. Valmistajan takuuajasta tuotteen materiaali- ja toimintavirheille on 24 kuukautta tuotteen ostopäivästä lukien. Takuun edellytyksenä on, että noudatetaan ajoneuvon valmistajan määrittelemää tuotteen vaihtoväliä. Takuu ei korvaa normaalista kulumisesta eikä mistään kiipailukäytöstä johtuvaa vauriota.

Tähelepanu: **EST**

Käesolev kataloog on ette nähtud ainult küünla tüübi määramiseks. Kataloogis antud küünalde sobivused ei ole siduvad / kohustuslikud. Samas ei vastuta tootja võimalike kahjude eest juhul, kui ei ole arvestatud käesoleva kataloogi soovitusi. Kataloogis antud soovitused ei kehti lennukitele paigaldatud, FAA poolt heaks kiidetud mootoritele.

Käesolevast kataloogist leiate süüteküünalde, eelsüüteküünalde ja küünlapiipude sobivuse, mis on ranges kooskõlas vastava mootori tootja nõuetega. Kuna NGK on paljudele suurtele autotootjatele süüteküünalde esmavalmistaja on tagatud toote kõrge kvaliteet ja valmistamise täpsus. Muüja poolne garantiiperiood materjalivigade või mitterahuldava töötamise osas on 24 kuud toote ostmise hetkest, eeldusel et täpselt on järgitud tootjapoolset süüteküünla soovitusetabelit ja vahetusintervalli. Arusaadavalt ei kuulu garantii alla süüteküünla normaalne kulumine, mis on otseses seoses sõiduki kasutamise aktiivsusega.

Upozornění: **CZ**

Aplikační tabulka slouží pouze pro výběr svíčky
Zveřejněním tohoto vydání ztrácení dříve vydané aplikační tabulky platnost
Na údaje obsažené v katalogu nelze uplatňovat právní nárok
V tomto vydání nejsou obsaženy doporučení podle směrnic FAA pro letecké pohony

Zapalovací, žhavicí svíčky a svíčkové fajfky uvedené v našem katalogu doporučujeme použít výhradně pro motory uvedené v katalogu. NGK nenese zodpovědnost za rozpoznatelné chyby, jako například tiskové chyby. Za bezchybnost a přeslibené vlastnosti ručí NGK v souladu se stávajícím stavem techniky. Základním předpokladem pro toto je odborné zacházení s produkty NGK. Záruka na vady materiálu, či nedostatečný výkon je 24 měsíců od data prodeje, pokud byl dodržen interval výměny předepsaný výrobcem vozidla. Záruka se nevztahuje na vady vzniklé běžným použitím a na jakékoliv užití při sportovních aktivitách.

Uwagi:

PL

Lista zastosowań służy wyłącznie wyborowi typów. Przez publikację niniejszego wydania wszystkie uprzednie listy zastosowań tracą ważność. Treść nie jest podstawą jakichkolwiek roszczeń prawnych. Niniejsze wydanie nie zawiera poleceń dla lotniczych zespołów napędowych według wytycznych FAA.

Nie podlega gwarancji przy normalnym zużyciu lub wykorzystywaniu w sporcie.

Świece zapłonowe, świece żarowe, końcówki przewodów zapłonowych mogą być zastosowane zgodnie z przyporządkowaniem w naszym katalogu. Widoczne pomyłki i błędy w druku podlegają szczególnej uwadze użytkowników. NGK gwarantuje bezbłądność oraz właściwości produktów odpowiadające obecnemu poziomowi techniki. Gwarancja obowiązuje tylko w przypadku prawidłowej eksploatacji produktów NGK. Gwarancja na błędy materiałowe wynosi 24 miesiące od dnia zakupu, jeżeli określone przez producenta pojazdu okresy wymiary nie zostały przekroczone. Wyłączone z tego są: normalne zużycie oraz produkty eksploatowane w sporcie motorowym.

Примечания: RUS

Данный перечень спецификаций предназначен только для выбора типа свечей.

С опубликованием данного издания все предшествующие перечни спецификаций теряют силу.

Содержание списка не может послужить основой для возникновения притязания.

Рекомендации для авиационных двигателей согласно директивам FAA в данное издание не включены.

Свечи зажигания, свечи накаливания и наконечники, приведенные в каталоге, могут быть установлены на конкретные двигатели в соответствии с рекомендациями в каталоге. Видимые ошибки и очевидные описки подлежат проверке со стороны пользователей. Отсутствие брака и правильность параметров продукции компания NGK гарантирует в соответствии с развитием техники. Гарантия действует только при надлежащей эксплуатации продукции компании NGK. Гарантия на отсутствие заводского брака и на качество используемых материалов действует 24 месяца с момента покупки товара, если иное не предписано производителем автомобиля. Исключение составляет нормальный износ а также использования продукции в гоночных двигателях. Автомобили производителей АвтоВАЗ обозначены VAZ, ГАЗ обозначены GAZ, УАЗ обозначены UAZ и Москвич MOSKWICZ. Не используйте для подбора свечей зажигания/накаливания обозначения LADA, VOLGA. Эти обозначения действуют для немецкого рынка.

Megjegyzések: H

Ez a katalógus csak a típusok kiválasztására szolgál.

Megjelenésével minden korábbi kiadás érvényét veszti.

Tartalma nem ad alapot jogigény benyújtására.

Nem tartalmazza a repülőgépek hajtóművekre vonatkozó FAA szerinti ajánlásokat.

Fentiek alól kivételt képez a természetes elhasználódás, illetve a sportcélú felhasználás esete.

A katalógusunkban felsorolt gyújtógyertyák, izzítógyertyák és gyertyapipák csak a katalógusban ajánlott motorokhoz használhatók. Észlelhető eltérések, úgymint nyomtatási hibák esetén a felhasználó kötelessége körültekintően eljárni. Az NGK garantálja a termék minőségét és az említett jellemzőket a műszaki tudományok jelenlegi állása szerint. Ennek alapvető feltétele az NGK termék megfelelő használata. A garancia anyag-, vagy gyártási hibára vonatkozóan 24 hónap az eladástól számítva, feltételezve a járműgyártó által előírt csereintervallum betartását. A garancia nem érvényes normál elhasználódásra és bármilyen versenyzés esetén.

Σχόλια:

GR

Αυτός ο κατάλογος εφαρμογών ισχύει μόνο για αναγνώριση τύπου.

Αυτός ο κατάλογος αντικαθιστά όλους τους προηγούμενους καταλόγους.

Δεν φέρουμε καμία ευθύνη σε θέματα εγγυήσεων που αφορούν εφαρμογές που δεν αναφέρονται στον κατάλογο εφαρμογών.

Μπουζί για αεροπορικές εφαρμογές δεν περιέχονται σ'αυτόν τον κατάλογο εφαρμογών.

Τα γπουζί, οι προθερμάνσεις και τα καλύμματα μπουζί που περιέχονται στον κατάλογο μπορούν να χρησιμοποιηθούν στους κινητήρες που προτείνονται στον κατάλογο. Τα αναγνωρίσιμα λάθη, όπως τα λάθη εκτύπωσης πρέπει να απομονώνονται από τον χρήστη. Η NGK παρακολουθεί την ακρίβεια και τα αναφερόμενα χαρακτηριστικά σύμφωνα με τη διαθέσιμη τεχνολογία. Βασική συνθήκη για αυτό είναι η κατάλληλη χρήση του προϊόντος NGK. Η περίοδος εγγύησης για προβλήματα στο υλικό ή για μειωμένη απόδοση είναι 24 μήνες από την ημερομηνία αγοράς, με την προϋπόθεση ότι τηρούνται τα διαστήματα αντικατάστασης που είναι καθορισμένα από τον κατασκευαστή του οχήματος. Εξαιρούνται από αυτό η φυσιολογική φθορά και οποιαδήποτε μορφή αγωνιστικών δραστηριοτήτων.

Αçıklama

TR

1. Bu liste sadece tiplerin belirlenmesinde kullanılır.
2. Bu baskının yayınlanmasıyla önceden yayınlanan tüm listelerin hükümleri ortadan kalkmış olur.
3. İçerikten dolayı hiçbir yasal hak talep edilemez.
4. Havaçılıkta kullanılan motorlarla ilgili FAA'nın talimatları doğrultusundaki tavsiyeler bu baskıda mevcut değildir.

Katalogda belirtilen bujiler, kızdırma bujileri ve bağlantı elemanları katalog tavsiyeleri doğrultusunda motorlarda kullanılabilir. Yanlış anlamalardan ve baskıdan kaynaklanan hatalarda sorumluluk tamamen uygulayıcıya aittir. Ürünün hatasız ve belirtilen özelliklere sahip oluşuyla ilgili olarak NGK, içerisinde bulunan teknolojik gelişmelerin güncelliğine bağlı kalmak kaydıyla, sorumluluk taşır. Bunun geçerliliği için temel koşul NGK ürününün doğru uygulanmış olmasıdır. Malzeme hatası yada hatalı ürün kapsamındaki garanti süresi, otomobil üreticisinin ön gördüğü periyodik değiştirme süresi aşılmadığı taktirde, satınalma tarihinden itibaren 24 aydır. Doğal aşınmaya bağlı eskime ve her türlü modifikasyon uygulaması (Racing, vb.) garanti kapsamının dışındadır.

		9-102
---	---	-------

		103-126
---	---	---------

		127-133
---	---	---------

			134-189
---	---	---	---------

		190-223
---	---	---------

		224
---	---	-----

BERU, BOSCH, BRISK, CHAMPION, DENSO, EYQUEM, HARLEY-DAVIDSON, HONDA, ISKRA, ISOLATOR, ITALJET, KAWASAKI, LODGE, MARELLI, SPLITFIRE, SUZUKI, YAMAHA → NGK _____ 225-260

	→					261-265
---	---	---	---	---	---	---------

				→		266-270
---	---	---	---	---	---	---------

Quick-No.	→	Order-No.	271
-----------	---	-----------	-----

Quick-No.	→					272
-----------	---	---	---	---	---	-----



				→	Quick-No.	273-274
---	---	---	---	---	-----------	---------







	→					275-277
---	---	---	---	---	---	---------

				→		278-282
---	---	---	---	---	---	---------

Racing	283-288
--------	---------

Standard 			FRIDIUM IX 		
Standard-type	IX Typen	Order No.	Standard-type	IX Typen	Order No.
B6HS	BR6HIX	3419	C8EH-9	CR8EHIX-9	3797
B7HS	BR7HIX	7067	C8HSA	CR8HIX	7669
B8ES	BR8EIX	5044	C9E	CR9EIX	3521
B8HS	BR8HIX	7001	C9EH-9	CR9EHIX-9	6216
B9ES	BR9EIX	3981	CR5HSA	CR5HIX	7120
B10ES	BR10EIX	6801	CR5HSB	CR5HIX	7120
BP5ES	BPR5EIX	6597	CR6HS	CR6HIX	7274
BP6ES	BPR6EIX	6637	CR6HSA	CR6HIX	7274
BP6HS	BPR6HIX	4085	CR7E	CR7EIX	7385
BP6HSA	BPR6HIX	4085	CR7HS	CR7HIX	7544
BP7ES	BPR7EIX	4055	CR7HSA	CR7HIX	7544
BP7HS	BPR7HIX	5944	CR8E	CR8EIX	4218
BP8HS	BPR8HIX	6742	CR8EB	CR8EIX	4218
BP8HSA	BPR8HIX	6742	CR8EH-9	CR8EHIX-9	3797
BPR5ES	BPR5EIX	6597	CR8HS	CR8HIX	7669
BPR6ES	BPR6EIX	6637	CR8HSA	CR8HIX	7669
BPR6HS	BPR6HIX	4085	CR9E	CR9EIX	3521
BPR6HSA	BPR6HIX	4085	CR9EB	CR9EIX	3521
BPR7ES	BPR7EIX	4055	CR9EH-9	CR9EHIX-9	6216
BPR7HS	BPR7HIX	5944	D8EA	DR8EIX	6681
BPR8HS	BPR8HIX	6742	D9EA	DR9EIX	4772
BPR8HSA	BPR8HIX	6742	DP7EA-9	DPR7EIX-9	7803
BR6HS	BR6HIX	3419	DP8EA-9	DPR8EIX-9	2202
BR6HSA	BR6HIX	3419	DP9EA-9	DPR9EIX-9	5545
BR7HS	BR7HIX	7067	DPR7EA-9	DPR7EIX-9	7803
BR8ES	BR8EIX	5044	DPR8EA-9	DPR8EIX-9	2202
BR8HS	BR8HIX	7001	DPR9EA-9	DPR9EIX-9	5545
BR8HSA	BR8HIX	7001	DR8EA	DR8EIX	6681
BR9ES	BR9EIX	3981	DR8EB	DR8EIX	6681
C5HSA	CR5HIX	7120	DR8ES	DR8EIX	6681
C5HSB	CR5HIX	7120	DR8ES-L	DR8EIX	6681
C6HSA	CR6HIX	7274	DR9EA	DR9EIX	4772
C7E	CR7EIX	7385			
C7HSA	CR7HIX	7544			
C8E	CR8EIX	4218			

FRIDIUM IX 			Standard 		
IX Typen	Gewinde	Order No.	Verwendbar für		
BPR5EIX	14 mm	6597	BP5ES, BPR5ES		
BPR6EIX	14 mm	6637	BP6ES, BPR6ES		
BPR6HIX	14 mm	4085	BP6HS, BP6HSA, BPR6HS, BPR6HSA		
BPR7EIX	14 mm	4055	BP7ES, BPR7ES		
BPR7HIX	14 mm	5944	BP7HS, BPR7HS		
BPR8HIX	14 mm	6742	BP8HS, BP8HSA, BPR8HS, BPR8HSA		
BR6HIX	14 mm	3419	B6HS, BR6HS, BR6HSA		
BR7HIX	14 mm	7067	B7HS, BR7HS		
BR8EIX	14 mm	5044	B8ES, BR8ES		
BR8HIX	14 mm	7001	B8HS, BR8HS, BR8HSA		
BR9EIX	14 mm	3981	B9ES, BR9ES		
BR10EIX	14 mm	6801	B10ES		
CR5HIX	10 mm	7120	C5HSA, C5HSB, CR5HSA, CR5HSB		
CR6HIX	10 mm	7274	C6HSA, CR6HS, CR6HSA		
CR7EIX	10 mm	7385	C7E, CR7E		
CR7HIX	10 mm	7544	C7HSA, CR7HS, CR7HSA		
CR8EHIX-9	10 mm	3797	C8EH-9, CR8EH-9		
CR8EIX	10 mm	4218	C8E, CR8E, CR8EB		
CR8HIX	10 mm	7669	C8HSA, CR8HS, CR8HSA		
CR9EHIX-9	10 mm	6216	C9EH-9, CR9EH-9		
CR9EIX	10 mm	3521	C9E, CR9E, CR9EB		
DPR7EIX-9	12 mm	7803	DP7EA-9, DPR7EA-9		
DPR8EIX-9	12 mm	2202	DP8EA-9, DPR8EA-9		
DPR9EIX-9	12 mm	5545	DP9EA-9, DPR9EA-9		
DR8EIX	12 mm	6681	D8EA, DR8EA, DR8EB, DR8ES, DR8ES-L		
DR9EIX	12 mm	4772	D9EA, DR9EA		

					Order No.		Gold-Palladium	Platin 	Order No.	Quick-No. 	Iridium	Order No.
ACCOSSATO												
Enduro Unitrac	50	03.74 -	B6ES	7310	0,7	B6EVX		5136				
CR 80 Cross/Enduro	80				0,5	B9EGV		5827				
AEON												
Cobra (ATV)	50	03 -	BPR7HS	6422	0,8	BPR7HVX		2938	215	BPR7HIX		5944
Minicolt (ATV)	50	03 -	BPR7HS	6422	0,8	BPR7HVX		2938	215	BPR7HIX		5944
Revo (ATV)	50	04 -	BPR7HS	6422	0,8	BPR7HVX		2938	215	BPR7HIX		5944
Cobra (ATV)	100	02 -	BPR7HS	6422	0,8	BPR7HVX		2938	215	BPR7HIX		5944
Revo (ATV)	100	04 -	BPR7HS	6422	0,8	BPR7HVX		2938	215	BPR7HIX		5944
Cobra Sport (ATV)	125	02 -	CR8HSA	2086	0,8	CR8HVX		7236		CR8HIX		7669
Cobra RS 1(ATV)	125		CR7HS	7223	0,8					CR7HIX		7544
Cobra RS 2(ATV)	125		CR7HS	7223	0,8					CR7HIX		7544
Overland (ATV)	125	04 -	CR7HS	7223	0,8					CR7HIX		7544
Utility (ATV)	125	02 -	CR7HS	7223	0,8					CR7HIX		7544
Cobra RS 2 (ATV)	180	04 -	CR7HSA	4549	0,8					CR7HIX		7544
Cobra Sport (ATV)	180	02 -	CR8HSA	2086	0,8	CR8HVX		7236		CR8HIX		7669
Cobra RS 1 (ATV)	180		CR7HS	7223	0,8					CR7HIX		7544
Cobra RS 2 (ATV)	180		CR7HS	7223	0,8					CR7HIX		7544
Overland (ATV)	180	04 -	CR7HS	7223	0,8					CR7HIX		7544
Utility (ATV)	180	02 -	CR7HS	7223	0,8					CR7HIX		7544
AJP												
Enduro 125	125	03 -	DR8ES	5423	0,8	DR8EVX		6354	217	DR8EIX		6681
Super-Moto 125	125	03 -	DR8ES	5423	0,8	DR8EVX		6354	217	DR8EIX		6681
P 250 Cross	250	04 -	CR8EB	7784	0,6	CR8EVX		6487		CR8EIX		4218
ALFER												
GR 30, TX 30	50		BR8HS	4322	0,6	BR8HVX		6265	212	BR8HIX		7001
MC 80	80				0,5	B9EGV		5827				
GR125 ISDE	125				0,5	B8EGV		5627				
MC 125	125				0,5	B9EGV		5827				
VRE 125 (4T)	125		CR9E	6263	0,7	CR9EVX		5943	227	CR9EIX		3521
VRE 125 no limit (4T)	125		CR9E	6263	0,7	CR9EVX		5943	227	CR9EIX		3521
EGR 250 Agua / Air	250		B8ES	2411	0,5	B8EGV		5627	201	BR8EIX		5044
MC 250	250				0,5	B9EGV		5827				
VR 250 (2T)	250		BR8ES	5422	0,8	BR8EVX		1262	207	BR8EIX		5044
VR 250 no limit Supermoto (2T)	250		BR8ES	5422	0,8	BR8EVX		1262	207	BR8EIX		5044
AR-1	300		B8ES	2411	0,5	B8EVX		7051	201	BR8EIX		5044
GR 300 Agua	300		B8ES	2411	0,5	B8EGV		5627	201	BR8EIX		5044
TX-300	300		B8ES	2411	0,5	B8EGV		5627	201	BR8EIX		5044
MC 500	490				0,5	B9EGV		5827				
APRILIA												
AF1 50	50	01.86 -	B9ES	2611	0,5	B9EVX		7254	202	BR9EIX		3981
Classic 50 (Gl)	50	99 -	BR8ES	5422	0,8	BR8EVX		1262	207	BR8EIX		5044
ET 50 AE,-Fire	50	01.87 -	B9ES	2611	0,5	B9EVX		7254	202	BR9EIX		3981
GL 50	50	02.93 -	B9ES	2611	0,5	B9EVX		7254	202	BR9EIX		3981
LX 50	50	02.93 -	B9ES	2611	0,5	B9EVX		7254	202	BR9EIX		3981
MX 50 (RX50)	50	03 -	BR9ES	5722	0,6	BR9EVX		1265	208	BR9EIX		3981
RC 50	50	01.79 -12.82	B6ES	7310	0,6	B6EVX		5136				
Red Rose 50	50	06.87 -	B9ES	2611	0,5	B9EVX		7254	202	BR9EIX		3981
RS 50 (PG)	50	01.97 -	BR8ES	5422	0,8	BR8EVX		1262	207	BR8EIX		5044



Order No.



Gold-Palladium

Platin



Order No.

Quick-No.









Iridium















Order No.

APRILIA

RS 50 Extrema/Replica	50	01.93 -	B8ES	2411	0,5	B8EGV	5627	201	BR8EIX	5044
RX 50	50	09.90 -	B9ES	2611	0,5	B9EVX	7254	202	BR9EIX	3981
Tuareg 50	50	01.87 -	B9ES	2611	0,5	B9EVX	7254	202	BR9EIX	3981
AF 1 Futura	125	06.90 -	B10EG	3630	0,5	B10EGV	5927			
AF 1 Sport	125	06.90 -	B10EG	3630	0,5	B10EGV	5927			
AF1 125 Replica 89	125	03.87 -	B10EG	3630	0,6	B10EGV	5927			
AF1 125, RR, Sintesi	125	06.88 -	B10EG	3630	0,5	B10EGV	5927			
AS 125 R	125	01.91 -	B9ES	2611	0,5	B9EVX	7254	202	BR9EIX	3981
Classic 125	125	97 - 98			0,6	BR10EG	3830			
Classic 125 (MF)	125	99 -	BR8ES	5422	0,8	BR8EVX	1262	207	BR8EIX	5044
ETX 125 (PH)	125	99 -	BR8ES	5422	0,8	BR8EVX	1262	207	BR8EIX	5044
ETX 125	125	01.84 - 98	B9ES	2611	0,5	B9EVX	7254	202	BR9EIX	3981
Europa 125	125	06.90 -	B10EG	3630	0,5	B10EGV	5927			
MX 125 Supermoto	125	04 -	BR8ES	5422	0,8	BR8EVX	1262	207	BR8EIX	5044
Pegaso 125	125	01.92 -	B10EG	3630	0,5	B10EGV	5927			
Red Rose 125	125	01.88 -	B10EG	3630	0,5	B10EGV	5927			
Red Rose 125	125	01.97 -	BR8ES	5422	0,8	BR8EVX	1262	207	BR8EIX	5044
RS 125 (MP) (11kW) (80km/h)	125	96 -	BR8ES	5422	0,8	BR8EVX	1262	207	BR8EIX	5044
RS 125 (MP) (18kW)	125	96 -	BR10EG	3830	0,5					
RS 125 (MP) (22kW)	125	99 -	BR10EG	3830	0,5					
RS 125 Extrema/Repli. 20kW	125	- 93	BR10EG	3830	0,5					
RS 125 Extrema/Repli. 23kW	125	- 93	BR10EG	3830	0,5					
RX 125	125	01.90 -	B10EG	3630	0,5	B10EGV	5927			
ST 125	125	01.82 -	B9EG	3530	0,5	B9EGV	5827		BR9EIX	3981
STX 125	125	01.82 -	B9EG	3530	0,5	B9EGV	5827		BR9EIX	3981
Tuareg	125	01.86 -	B9ES	2611	0,5	B9EVX	7254	202	BR9EIX	3981
Tuareg Rallye	125	06.89 -	B10EG	3630	0,5	B10EGV	5927			
Tuareg Wind 125	125	07.88 -	B9ES	2611	0,6	B9EVX	7254	202	BR9EIX	3981
250 GP (I)	250		B10EG	3630	0,5	B10EGV	5927			
RS 250 ((LD)	250	95 -	BR9ECM	3252	0,5	BR9ECMVX	2434			
RX 250	250	01.85 -04.86	B10EG	3630	0,5	B10EGV	5927			
Tuareg Rally	250	01.85 -	B10EG	3630	0,5	B10EGV	5927			
Climber	276	01.89 -	BP5ES	6511	0,7	BP5EVX	5470		BPR5EIX	6597
TX 300	276	- 84	BP5ES	6511	0,7	BP5EVX	5470		BPR5EIX	6597
TX 311 M	276	- 84	BP5ES	6511	0,7	BP5EVX	5470		BPR5EIX	6597
TXR 312 M	276	- 86	BP5ES	6511	0,5	BP5EVX	5470		BPR5EIX	6597
TL 320	320	- 86	BP5ES	6511	0,5	BP5EVX	5470		BPR5EIX	6597
EXT 350	349	01.85 -	D8EA	2120	0,5	D8EVX	2850	216	DR8EIX	6681
Tuareg 350	349	01.87 - 91	D8EA	2120	0,5	D8EVX	2850	216	DR8EIX	6681
Wind	349	01.87 -	D8EA	2120	0,5	D8EVX	2850	216	DR8EIX	6681
Tuareg 600 Wind	562	01.88 - 93	D8EA	2120	0,6	D8EVX	2850	216	DR8EIX	6681
Pegaso 600	600	03.90 - 94	D8EA	2120	0,6	D8EVX	2850	216	DR8EIX	6681
Moto 6.5 (MH)	650	95 -	D8EA	2120	0,6	D8EVX	2850	216	DR8EIX	6681
Pegaso 650 (ML) Kat.	650	97 - 00	DR8EA	7162	0,7	DR8EVX	6354		DR8EIX	6681
Pegaso 650 (GA)	650	04.92 - 95	DR8EA	7162	0,7	DR8EVX	6354		DR8EIX	6681
Pegaso 650 (MX)	650	96 - 00	DR8EA	7162	0,7	DR8EVX	6354		DR8EIX	6681
Pegaso 650 (ML)	650	97 - 00	DR8EA	7162	0,7	DR8EVX	6354		DR8EIX	6681
Pegaso 650 i.e. (RW)	650	01 - 03	DR8EB	4855	0,7				DR8EIX	6681
Pegaso Cube 650	650	97 -	DR8EA	7162	0,7	DR8EVX	6354		DR8EIX	6681
SL 1000 Falco	998	99 -	DCPR9E	2641	0,7	DCPR9EVX	6436		DCPR9EIX	2316
ETV CapoNord (PS)	1000	01 -	DCPR9E	2641	0,7	DCPR9EVX	6436		DCPR9EIX	2316
RST Futura (PW)	1000	01 -	DCPR9E	2641	0,7	DCPR9EVX	6436		DCPR9EIX	2316

					Order No.		Platin 	Order No.	Quick-No.	Iridium 	Order No.
APRILIA											
RSV 1000 R Factory	1000	03 -	DCPR9E	2641	0,7	DCPR9EVX	6436			DCPR9EIX	2316
RSV 1000 R	1000	04 -	DCPR9E	2641	0,7	DCPR9EVX	6436			DCPR9EIX	2316
RSV mille (MEA;ME;ME0010)	1000	98 -	DCPR9E	2641	0,7	DCPR9EVX	6436			DCPR9EIX	2316
RSV mille R	1000	98 - 03	DCPR9E	2641	0,7	DCPR9EVX	6436			DCPR9EIX	2316
RSV mille 01 (RP)	1000	01 -	DCPR9E	2641	0,7	DCPR9EVX	6436			DCPR9EIX	2316
RSV mille SP (MED)	1000	99 -	R0045J-10	7400	1,1						
SL 1000 (PA)	1000	99 -	DCPR9E	2641	0,7	DCPR9EVX	6436			DCPR9EIX	2316
Tuono Fighter 1000	1000	03 -	DCPR9E	2641	0,7	DCPR9EVX	6436			DCPR9EIX	2316
Tuono Fighter R 1000	1000	03 -	DCPR9E	2641	0,7	DCPR9EVX	6436			DCPR9EIX	2316
ARCTIC CAT											
90 (ATV)	90	02 -	BPR7HS	6422	0,6	BPR7HVX	2938	215		BPR7HIX	5944
250 Quad 4x4 (ATV)	250	01 -	DR7EA	7839	0,6						
300 Quad 2x4 / 4x4 (ATV)	300	99 -	DR7EA	7839	0,6						
300 (ATV)	300	04 -	DR7EA	7839	0,6						
375 (ATV)	375	02 -	CR7E	4578	0,8			225		CR7EIX	7385
400 (ATV)	400	99 - 01	CR6E	6965	0,7						
400 (ATV)	400	03 -	CR7E	4578	0,8			225		CR7EIX	7385
400 (ATV)	400	- 98	CR8E	1275	0,7	CR8EVX	6487	226		CR8EIX	4218
400 (ATV)	400	04 -	CR7E	4578	0,6			225		CR7EIX	7385
400 TBX (ATV)	400	04 -	CR7E	4578	0,6			225		CR7EIX	7385
400i (ATV)	400	04 -	CR7E	4578	0,6			225		CR7EIX	7385
454 (ATV)	454	96 - 97	CR8E	1275	0,7	CR8EVX	6487	226		CR8EIX	4218
454 (ATV)	454	98 -	CR6E	6965	0,7						
500 (ATV)	493	99 -	CR6E	6965	0,7						
500 Auto (ATV)	493	01 -	CR6E	6965	0,7						
500 TBX (ATV)	500	04 -	CR6E	6965	0,7						
500 TRV (ATV)	500	04 -	CR6E	6965	0,7						
ARM											
125 Cross	125				0,5	B11EGV	5831				
125 Velocidad Enduro	125				0,5	B10EGV	5927				
250 Velocidad Enduro/Cross	250				0,5	B9EGV	5827				
365 Enduro	350				0,5	B9EGV	5827				
AT MOTO											
S 3800 (Velo Solex)	50		B6HS	4510	0,6	B6HVX	7435	203		BR6HIX	3419
ATK											
50 Mini Quad (ATV)	50	01 -	B7HS	5110	0,5	B7HVX	7836	204		BR7HIX	7067
90 Mini Quad (ATV)	90	01 -	B7HS	5110	0,5	B7HVX	7836	204		BR7HIX	7067
350 Enduro 4 Ventil / 4 Stroke SOHC	350	91 - 00	D8EA	2120	0,5	D8EVX	2850	216		DR8EIX	6681
350 Cross 4 Ventil / 4 Stroke SOHC	350	91 -	D8EA	2120	0,5	D8EVX	2850	216		DR8EIX	6681
406	400	96 - 99	B8ES	2411	0,5	B8EVX	7051	201		BR8EIX	5044
500 DT 4 Ventil / 4 Stroke SOHC	490	99 -	D8EA	2120	0,5	D8EVX	2850	216		DR8EIX	6681
Supermot 4 Ventil / 4 Stroke SOHC	500	01 -	D8EA	2120	0,5	D8EVX	2850	216		DR8EIX	6681
604 4 Ventil / 4 Stroke SOHC	560	93 -	D8EA	2120	0,5	D8EVX	2850	216		DR8EIX	6681
605 Cross 4 Ventil / 4 Stroke SOHC	600	93 -	D8EA	2120	0,5	D8EVX	2850	216		DR8EIX	6681
605 Enduro 4 Ventil / 4 Stroke SOHC	600	93 - 00	D8EA	2120	0,5	D8EVX	2850	216		DR8EIX	6681
Supermot 4 Ventil / 4 Stroke SOHC	600	01 -	D8EA	2120	0,5	D8EVX	2850	216		DR8EIX	6681
605 DT 4 Ventil / 4 Stroke SOHC	600	98 -	D8EA	2120	0,5	D8EVX	2850	216		DR8EIX	6681

					Order No.		Platin 	Order No.	Quick-No.	Iridium 	Order No.
AVIAN											
RM 125 (Tau Motor)	125				0,5	B10EGV	5927				
RM 250 (Tau Motor)	250				0,5	B8EGV	5627				
AWO											
425 T	425	56 -	B7HS	5110	0,5	B7HVX	7836	204	BR7HIX		7067
B.S.A											
Tracker	125		B8ES	2411	0,5	B8EVX	7051	201	BR8EIX		5044
Bantam 175, Bushman	175		B7ES	1111	0,5	B7EVX	6934				
Bantam D10, 14, 14/4, 14/5	175		B7ES	1111	0,5	B7EVX	6934				
Tracker	175		B8ES	2411	0,5	B8EVX	7051	201	BR8EIX		5044
B25 R / SS Gold Star	250		B8ES	2411	0,5	B8EVX	7051	201	BR8EIX		5044
B25 Starfire, B25T Victor	250		B8ES	2411	0,5	B8EVX	7051	201	BR8EIX		5044
B40 SS90	350		B7ES	1111	0,5	B7EVX	6934				
A50W, B50MX, Victor MC	500		B8ES	2411	0,5	B8EVX	7051	201	BR8EIX		5044
B50SS, Gold Star, B50T Vict.	500		B7ES	1111	0,5	B7EVX	6934				
A75 Rocket 3	750		B8ES	2411	0,6	B8EVX	7051	201	BR8EIX		5044
BATAVUS											
G50, Mosquito, M40, TS49	50		B6HS	4510	0,5	B6HVX	7435	203	BR6HIX		3419
Go-Go2,-V,-S	50		B6HS	4510	0,5	B6HVX	7435	203	BR6HIX		3419
TS 49 S	50		B8HS	5510	0,5	B8HVX	2634	205	BR8HIX		7001
BELGARDA											
DT / TDR / TZR (Yamaha)	125		B9ES	2611	0,5	B9EVX	7254	202	BR9EIX		3981
TZR 125 R S/P (Yamaha)	125				0,5	B10EGV	5927				
BENELLI											
G2, Elle, Pedali	50	01.83 -06.89	B6HS	4510	0,5	B6HVX	7435	203	BR6HIX		3419
Gentleman, Magnum 5V	50		B5ES	6410	0,5						
Laser	50	01.84 -06.89	B6HS	4510	0,5	B6HVX	7435	203	BR6HIX		3419
Magnum 3V	50		B7ES	1111	0,5	B7EVX	6934				
S50	50	04.81 -06.89	B6HS	4510	0,5	B6HVX	7435	203	BR6HIX		3419
Spring 50	50		B8ES	2411	0,5	B8EVX	7051	201	BR8EIX		5044
125	125		B6HS	4510	0,5	B6HVX	7435	203	BR6HIX		3419
125-2C Twin	125		B7ES	1111	0,5	B7EVX	6934				
Jarno	125		B8ES	2411	0,5	B8EVX	7051	201	BR8EIX		5044
Scooter S-125	125		B7HS	5110	0,5	B7HVX	7836	204	BR7HIX		7067
304	230	09.82 -	B7HS	5110	0,6	B7HVX	7836	204	BR7HIX		7067
250	250		B6ES	7310	0,5	B6EVX	5136				
250 Quattro	250	10.77 -06.80	B7HS	5110	0,6	B7HVX	7836	204	BR7HIX		7067
254	250	01.80 -07.82	B7HS	5110	0,6	B7HVX	7836	204	BR7HIX		7067
2C, 2CE, Sport Speciale	250		B7ES	1111	0,5	B7EVX	6934				
500 LS, Quattro, 504 / Sport	500		D8EA	2120	0,5	D8EVX	2850	216	DR8EIX		6681
654 / Sport / 4C	650		D8EA	2120	0,5	D8EVX	2850	216	DR8EIX		6681
Tornado 650/S/SV	650		B8ES	2411	0,5	B8EVX	7051	201	BR8EIX		5044
750 Sei	750		D8EA	2120	0,5	D8EVX	2850	216	DR8EIX		6681
900 Sei VT/NT	900		D8EA	2120	0,5	D8EVX	2850	216	DR8EIX		6681
Tornado RS / LE	900	05 -	C7E	5096	0,6				CR7EIX		7385
Tornado TRE	900	05 -	C7E	5096	0,6				CR7EIX		7385
Tornado 900	900	00 -	CR9E	6263	0,7	CR9EVX	5943	227	CR9EIX		3521
TNT 1130	1130	05 -	CR9E	6263	0,7	CR9EVX	5943	CR9EIX			3521

					Order No.		Gold-Palladium	Platin 	Order No.	Quick-No.	Iridium 	Order No.
BENELLI												
Stilo / AI	50		B6HS	4510	0,5	B6HVX	7435	203	BR6HIX		3419	
BETA												
ALP 50	50	93 -	B8ES	2411	0,5	B8EVX	7051	201	BR8EIX		5044	
Bad	50		B9ES	2611	0,5	B9EVX	7254	202	BR9EIX		3981	
KR-50	50		B6ES	7310	0,5	B6EVX	5136					
Minicross 10/10	50	00 -	B7HS	5110	0,5	B7HVX	7836	204	BR7HIX		7067	
Minicross 12/15	50	00 -	B7HS	5110	0,5	B7HVX	7836	204	BR7HIX		7067	
Minitrail	50	00 -	B7HS	5110	0,5	B7HVX	7836	204	BR7HIX		7067	
MX 50	50	93 -	B9ES	2611	0,5	B9EVX	7254	202	BR9EIX		3981	
REV 50	50	04 -	B9ES	2611	0,5	B9EVX	7254	202	BR9EIX		3981	
RK 6-50	50		B8ES	2411	0,5	B8EVX	7051	201	BR8EIX		5044	
RR Enduro	50		B10ES	7928	0,5	B10EVX	7335		BR10EIX		6801	
Super Trail	50		B8ES	2411	0,5	B8EVX	7051	201	BR8EIX		5044	
Supermotard 50	50		B10ES	7928	0,5	B10EVX	7335		BR10EIX		6801	
Tempo / Crono	50		BR7HS	4122	0,5			211	BR7HIX		7067	
Tempo 50	50		BR7HS	4122	0,5			211	BR7HIX		7067	
Tempo Crono	50		BR7HS	4122	0,5			211	BR7HIX		7067	
TR-50	50		B6ES	7310	0,5	B6EVX	5136					
Zero 50	50		B9ES	2611	0,5	B9EVX	7254	202	BR9EIX		3981	
REV 80	80	04 -	B9ES	2611	0,5	B9EVX	7254	202	BR9EIX		3981	
Dougie Lampkin Replica	124		B8ES	2411	0,5	B8EVX	7051	201	BR8EIX		5044	
Alp 4T	125	00 -	DR8EA	7162	0,7	DR8EVX	6354		DR8EIX		6681	
REV 3	125	00 -	B8ES	2411	0,5	B8EVX	7051	201	BR8EIX		5044	
Techno 125	125		BP7ES	2412	0,6	BP7EVX	7270	206	BPR7EIX		4055	
TR-34	125		B8ES	2411	0,5	B8EVX	7051	201	BR8EIX		5044	
Zero 125	125		B8ES	2411	0,5	B8EVX	7051	201	BR8EIX		5044	
Alp	200		DR8EA	7162	0,7	DR8EVX	6354		DR8EIX		6681	
Alp 4T	200	00 -	DR8EA	7162	0,7	DR8EVX	6354		DR8EIX		6681	
REV 3	200		BP7ES	2412	0,5	BP7EVX	7270	206	BPR7EIX		4055	
TR-33	240		B6ES	7310	0,5	B6EVX	5136					
Dougie Lampkin Replica	247		BP7ES	2412	0,5	BP7EVX	7270	206	BPR7EIX		4055	
Alp 250	250		B8ES	2411	0,5	B8EVX	7051	201	BR8EIX		5044	
REV 3	250	00 -	B8ES	2411	0,5	B8EVX	7051	201	BR8EIX		5044	
Super Trail 250	250		B8ES	2411	0,5	B8EVX	7051	201	BR8EIX		5044	
Techno	250		BCP7ES	5030	0,5	BCP7EV	3733					
Alp	260		B8ES	2411	0,5	B8EVX	7051	201	BR8EIX		5044	
Super Trail	260		B8ES	2411	0,5	B8EVX	7051	201	BR8EIX		5044	
Synt 260	260		B8ES	2411	0,5	B8EVX	7051	201	BR8EIX		5044	
TR-34/Campionato	260		B8ES	2411	0,5	B8EVX	7051	201	BR8EIX		5044	
Zero	260		B8ES	2411	0,5	B8EVX	7051	201	BR8EIX		5044	
Alp 4.0 4 Stroke	350	03 -	CR9EK	4548	0,7			230	CR9EIX		3521	
Euro 350	350		CR9EK	4548	0,7			230	CR9EIX		3521	
Jonathan 350	350		CR9EK	4548	0,7			230	CR9EIX		3521	
Motard 4.0 4 Stroke	350	03 -	CR9EK	4548	0,7			230	CR9EIX		3521	
BIMOTA												
YB-9 Bellaria	600		CR9E	6263	0,7	CR9EVX	5943	227	CR9EIX		3521	
YB-9 SR	600	95 -	CR9E	6263	0,7	CR9EVX	5943	227	CR9EIX		3521	
BB 1 Supermono / Biposto	650	95 -	D8EA	2120	0,7	D8EVX	2850	216	DR8EIX		6681	
DB-1/S	750		BP7HS	5111	0,5	BP7HVX	7468		BPR7HIX		5944	
SB 7	750		CR9EK	4548	0,7			230	CR9EIX		3521	



Order No.



Gold-Palladium

Platin



Order No.

Quick-No.

Iridium



Order No.

BIMOTA







YB-4	750		DR8EA	7162	0,7	DR8EVX	6354		DR8EIX	6681
Tesi 1	851	92 -			0,6	D9EVX	2834		DR9EIX	4772
DB-2	900	92 -	DPR8EA-9	4929	0,9	DPR8EVX-9	2872	221	DPR8EIX-9	2202
DB-2 SR	900		DPR8EA-9	4929	0,9	DPR8EVX-9	2872	221	DPR8EIX-9	2202
DB-3 Mantra	904	95 -	DPR8EA-9	4929	0,9	DPR8EVX-9	2872	221	DPR8EIX-9	2202
SB 8 R	1000	99 -	CR9EK	4548	0,7			230	CR9EIX	3521
YB-6	1000		DR8ESL	2923	0,7	DR8EVX	6354	218	DR8EIX	6681
YB-8 EXUP	1000	95 -	DR8ESL	2923	0,7	DR8EVX	6354	218	DR8EIX	6681
YB 11	1002	96 -	DR8EA	7162	0,7	DR8EVX	6354		DR8EIX	6681
SB 6	1100		CR9E	6263	0,7	CR9EVX	5943	227	CR9EIX	3521
SB 6 R	1100	97 -	CR9E	6263	0,7	CR9EVX	5943	227	CR9EIX	3521
SB-5/S	1150		DPR9EA-9	5329	0,9	DPR9EVX-9	3854	222	DPR9EIX-9	5545
YB-5	1200		DPR8EA-9	4929	0,9	DPR8EVX-9	2872	221	DPR8EIX-9	2202









BLATA







Elite 13 / 13W	40		B9ES	2611	0,8	B9EVX	7254	202	BR9EIX	3981
Elite 13S / 13WR / 13WRS	40				0,5	B9EGV	5827			
Elite 13	40		B9ES	2611	0,5	B9EVX	7254	202	BR9EIX	3981
Elite 13 R	40				0,5	B9EGV	5827			
Elite 13 W R S	40				0,5	B9EGV	5827			
Elite 13 W	40		B9ES	2611	0,5	B9EVX	7254	202	BR9EIX	3981
Elite 13 W R	40				0,5	B9EGV	5827			

BMW

R 20 (220/1)	192	37 - 38	B6HS	4510	0,7	B6HVX	7435	203	BR6HIX	3419
R 23 (223/1)	192	38 - 40	B6HS	4510	0,7	B6HVX	7435	203	BR6HIX	3419
R 24	250	48 - 50	B8HS	5510	0,6	B8HVX	2634	205	BR8HIX	7001
R 25	250	50 - 51	B8HS	5510	0,6	B8HVX	2634	205	BR8HIX	7001
R 25/2	250	51 - 53	B8HS	5510	0,6	B8HVX	2634	205	BR8HIX	7001
R 25/3	250	53 - 56	B8HS	5510	0,6	B8HVX	2634	205	BR8HIX	7001
R 26	250	56 - 60	B8HS	5510	0,6	B8HVX	2634	205	BR8HIX	7001
R 27	250	60 - 67	B8HS	5510	0,6	B8HVX	2634	205	BR8HIX	7001
R 51/2	250	50 - 51	B8HS	5510	0,6	B8HVX	2634	205	BR8HIX	7001
R 51/3	250	51 - 54	B8HS	5510	0,6	B8HVX	2634	205	BR8HIX	7001
R 3 (203/1)	305	36 - 36	B6HS	4510	0,7	B6HVX	7435	203	BR6HIX	3419
R 45 26kW	475	06.78 -06.83	BP7ES	2412	0,6	BP7EVX	7270	206	BPR7EIX	4055
R 45 20kW	475	06.78 -07.85	BP6ES	7811	0,6	BP6EVX	5832		BPR6EIX	6637
R 5 (254)	494	36 - 37	B7HS	5110	0,7	B7HVX	7836	204	BR7HIX	7067
R 50	500	55 - 69	B8HS	5510	0,6	B8HVX	2634	205	BR8HIX	7001
R 50/5	500		BP7ES	2412	0,6	BP7EVX	7270	206	BPR7EIX	4055
R 50S	500	60 - 62	B8HS	5510	0,6	B8HVX	2634	205	BR8HIX	7001
R 52	500	28 - 29	B6HS	4510	0,6	B6HVX	7435	203	BR6HIX	3419
R 6 (261)	600	37 - 37	B6HS	4510	0,7	B6HVX	7435	203	BR6HIX	3419
R 60	600	56 - 69	B8HS	5510	0,6	B8HVX	2634	205	BR8HIX	7001
R 60/5, /6, /7	600	-06.78	BP7ES	2412	0,6	BP7EVX	7270	206	BPR7EIX	4055
R 67	600	51 -	B8HS	5510	0,6	B8HVX	2634	205	BR8HIX	7001
R 67/2	600	52 - 54	B8HS	5510	0,6	B8HVX	2634	205	BR8HIX	7001
R 68	600	52 - 54	B8HS	5510	0,6	B8HVX	2634	205	BR8HIX	7001
R 69	600	55 - 60	B8HS	5510	0,6	B8HVX	2634	205	BR8HIX	7001
R 69S	600	60 - 69	B8HS	5510	0,6	B8HVX	2634	205	BR8HIX	7001
F 650 TwinSpark (BMS-C II)	650	09.04 -	DR8EB	4855	0,6				DR8EIX	6681
F 650 25kW	650	93 - 99	D8EA	2120	0,7	D8EVX	2850	216	DR8EIX	6681

					Order No.		Gold-Palladium	Platin 	Order No.	Quick-No.	Iridium 	Order No.
BMW												
F 650	34kW	650	93 - 99	D8EA	2120	0,7	D8EVX	2850	216	DR8EIX		6681
F 650 ST	34kW	650	97 - 99	D8EA	2120	0,6	D8EVX	2850	216	DR8EIX		6681
F 650 GS	25kW	650	00-08.03	D8EA	2120	0,6	D8EVX	2850	216	DR8EIX		6681
F 650 GS	34kW	650	00-08.03	D8EA	2120	0,6	D8EVX	2850	216	DR8EIX		6681
F 650 CS		650	02-08.03	DR8EB	4855	0,6				DR8EIX		6681
R 65		650	06.78 -	BP7ES	2412	0,6	BP7EVX	7270	206	BPR7EIX		4055
R 16 Serie 1-5		736	29 - 35	B6HS	4510	0,7	B6HVX	7435	203	BR6HIX		3419
R 17 (M60)		736	35 - 37	A6	1010	0,7						
R 11 Serie 1-5		745	29 - 34	B6HS	4510	0,7	B6HVX	7435	203	BR6HIX		3419
R 12 2-Vergaser (M56S6&212)		745	35 - 42	B6HS	4510	0,7	B6HVX	7435	203	BR6HIX		3419
K 75 S		750	- 96	D7EA	7912	0,6	D7EVX	2734				
K 75		750	06.85 - 96	D7EA	7912	0,6	D7EVX	2734				
K 75 RT		750	- 96	D7EA	7912	0,6	D7EVX	2734				
R 75/5, /6, /7		750		BP6ES	7811	0,6	BP6EVX	5832		BPR6EIX		6637
R 80 RT		800	08.82 - 95	BP6ES	7811	0,7	BP6EVX	5832		BPR6EIX		6637
R 80 ST		800	08.82 - 95	BP6ES	7811	0,7	BP6EVX	5832		BPR6EIX		6637
R 80 GS		800	08.82 - 94	BP6ES	7811	0,7	BP6EVX	5832		BPR6EIX		6637
R 80 R		800	80 -	BP6ES	7811	0,7	BP6EVX	5832		BPR6EIX		6637
R 80		800	08.82 - 95	BP6ES	7811	0,7	BP6EVX	5832		BPR6EIX		6637
R 80/7N /7S		800	09.77 -08.80	BP6ES	7811	0,7	BP6EVX	5832		BPR6EIX		6637
R 850 GS		850	98 -	BKR7EKC	7354							
R 850 R	52kW	850	10.94 -	BKR7EKC	7354							
R 850 RT		850	99 -	BKR7EKC	7354							
R 90/6		900		BP6ES	7811	0,6	BP6EVX	5832		BPR6EIX		6637
R 90/S		900		BP7ES	2412	0,6	BP7EVX	7270	206	BPR7EIX		4055
K 100 LT / RT	65kW	1000	09.83 -11.91	D7EA	7912	0,5	D7EVX	2734				
K 100 RS 4V		1000		DR7EA	7839	0,6						
K 100 RS	65kW	1000	09.83 -12.89	D7EA	7912	0,6	D7EVX	2734				
K 100 RS	72-74kW	1000	01.90 - 93	D7EA	7912	0,6	D7EVX	2734				
K 1	72-74kW	1000	05.89 - 93	DR7EA	7839	0,6						
R 100 R		1000	94 -	BP6ES	7811	0,6	BP6EVX	5832		BPR6EIX		6637
R 100		1000		BP7ES	2412	0,6	BP7EVX	7270	206	BPR7EIX		4055
R 100 RS		1000	09.86 -	BP6ES	7811	0,6	BP6EVX	5832		BPR6EIX		6637
R 100/7		1000		BP6ES	7811	0,6	BP6EVX	5832		BPR6EIX		6637
R 100/CS /RT		1000		BP7ES	2412	0,6	BP7EVX	7270	206	BPR7EIX		4055
R 100/RS		1000	-08.86	BP7ES	2412	0,6	BP7EVX	7270	206	BPR7EIX		4055
R 100 GS		1000	09.86 -	BP6ES	7811	0,6	BP6EVX	5832		BPR6EIX		6637
R 100/S /T		1000	09.76 -08.80	BP7ES	2412	0,6	BP7EVX	7270	206	BPR7EIX		4055
K 1100 LT	72-74kW	1100	01.92 - 98	DR7EA	7839	0,6						
K 1100 RS	72-74kW	1100	01.92 - 96	DR7EA	7839	0,6						
R 1100 S	all models	1100	01.03 -	BKR7EKC + DCPR8EKC	7354+ 7168							
R 1100 GS	59kW	1100	08.93 - 99	BCP7ET	2078	0,8						
R 1100 R	59kW	1100	10.94 - 01	BCP7ET	2078	0,8						
R 1100 RS	66kW	1100	11.92 - 01	BCP7ET	2078	0,8						
R 1100 RT	66kW	1100	09.95 - 01	BCP7ET	2078	0,8						
R 1100 S	72kW	1100	98 - 03	BKR7EKC	7354							
R 1100 S	Boxer Cup	1100	02 - 03	BKR7EKC	7354							
R 1150	all models	1150	01.03 -	BKR7EKC + DCPR8EKC	7354+ 7168							
R 1150 GS	not twinspark	1150	99 - 03	BKR7EKC	7354							
R 1150 GS	Adventure	1150	02 - 03	BKR7EKC	7354							

								
	Order No.	Order No.	Order No.	Order No.	Order No.	Order No.	Order No.	Order No.
BMW								
R 1150 R not twinspark	1150	01 - 03	BKR7EKC	7354				
R 1150 RT not twinspark	1150	01 - 03	BKR7EKC	7354				
K 1200 RS 96kW	1200	97 -	DCPR7E	3932	0,8	DCPR7EVX	1179	DCPR7EIX 6046
K 1200 RS 72kW	1200	97 -	DCPR7E	3932	0,8	DCPR7EVX	1179	DCPR7EIX 6046
K 1200 GT	1200	03 -	DCPR7E	3932	0,8	DCPR7EVX	1179	DCPR7EIX 6046
K 1200 LT 85kW	1200	04 -	DCPR7E	3932	0,8	DCPR7EVX	1179	DCPR7EIX 6046
K 1200 LT	1200	98 -	DCPR7E	3932	0,8	DCPR7EVX	1179	DCPR7EIX 6046
K 1200 LT 72kW	1200	97 -	DCPR7E	3932	0,8	DCPR7EVX	1179	DCPR7EIX 6046
R 1200 C	1200		BKR7EKC	7354				
R 1200 CL	1200	03 -	BKR7EKC	7354				
BOMBARDIER								
50 Quest (ATV)	50	03 - 03	BPR7HS	6422	0,6	BPR7HVX	2938 215	BPR7HIX 5944
50 DS (ATV)	50	02 -	BPR7HS	6422	0,6	BPR7HVX	2938 215	BPR7HIX 5944
DS 50 (ATV)	50	04 -	BR9ECS	3570	0,5			
Quest 50 (ATV)	50	04 -	BR9ECS	3570	0,5			
90 DS (ATV)	83	02 -	BPR7HS	6422	0,6	BPR7HVX	2938 215	BPR7HIX 5944
90 DS 4stroke (ATV)	90	02 -	CR7HSA	4549	0,7			CR7HIX 7544
90 Quest (ATV)	90	03 - 03	CR7HSA	4549	0,7			CR7HIX 7544
DS 90 (ATV)	90	04 -	BR9ECS	3570	0,5			
Quest 90 (ATV)	90	04 -	BR9ECS	3570	0,5			
175 (ATV)	175	03 -	CR8E	1275	0,7	CR8EVX	6487 226	CR8EIX 4218
Rally 200 (ATV)	176	04 -	BR9ECS	3570	0,5			
200 Rally (ATV)	200	03 -	CR8E	1275	0,7	CR8EVX	6487 226	CR8EIX 4218
330 (ATV)	330	02 -	DCPR8E	4339	0,9	DCPR8EVX	2265	DCPR8EIX 6546
Outlander 330 (ATV)	330	04 -	BR9ECS	3570	0,5			
400 Outlander (ATV)	400	03 -	DCPR8E	4339	0,9	DCPR8EVX	2265	DCPR8EIX 6546
Outlander 400 (ATV)	400	04 -	BR9ECS	3570	0,5			
Quest 498 (ATV)	498	03 -	BR9ECS	3570	0,5			
Traxter 498 (ATV)	498	03 -	BR9ECS	3570	0,5			
500 (ATV)	500	02 -	DCPR8E	4339	0,9	DCPR8EVX	2265	DCPR8EIX 6546
500 Traxter 7401 (ATV)	500	99 - 02	DR8EA	7162	0,7	DR8EVX	6354	DR8EIX 6681
500 Traxter 7414 (ATV)	500	98 - 02	DR8EA	7162	0,7	DR8EVX	6354	DR8EIX 6681
Quest 644 (ATV)	644	03 -	BR9ECS	3570	0,5			
650 Quest (ATV)	650	02 - 03	DCPR8E	4339	0,9	DCPR8EVX	2265	DCPR8EIX 6546
650 Traxter DS / DR (ATV)	650	00 -	DR8EA	7162	0,7	DR8EVX	6354	DR8EIX 6681
650 DS 653 (ATV)	653	03 -	BR9ECS	3570	0,5			
BOOM TRIKE								
Classic Trike Chopper VW (Vergaser mit Leistungssteigerung)	1600		B7HS	5110	0,6		204	BR7HIX 7067
Classic Trike Chopper VW (Einspritzer ohne Leistungssteigerung)	1600		BP5ESA	2285	0,8			BPR5EIX 6597
Classic Trike Chopper VW (Vergaser ohne Leistungssteigerung)	1600		B6HS	4510	0,6		203	BR6HIX 3419
Classic Trike Family VW (Einspritzer ohne Leistungssteigerung)	1600		BP5ESA	2285	0,8			BPR5EIX 6597
Classic Trike Family VW (Vergaser mit Leistungssteigerung)	1600		B7HS	5110	0,6		204	BR7HIX 7067
Classic Trike Family VW (Vergaser ohne Leistungssteigerung)	1600		B6HS	4510	0,6		203	BR6HIX 3419

					Order No.		Gold-Palladium	Platin 	Order No.	Quick-No.	Iridium 	Order No.
BOOM TRIKE												
Classic Trike Low Rider VW (Einspritzer ohne Leistungssteigerung)	1600			BP5ESA	2285	0,8					BPR5EIX	6597
Classic Trike Low Rider VW (Vergaser ohne Leistungssteigerung)	1600			B6HS	4510	0,6				203	BR6HIX	3419
Classic Trike Low Rider VW (Vergaser mit Leistungssteigerung)	1600			B7HS	5110	0,6				203	BR7HIX	7067
Fighter Automatik FORD Motor	1600			PTR5A-13	2467	1,3						
Fighter Automatik FORD Motor	2000			PTR5A-13	2467	1,3						
BOSS												
HOSS	8226			BPR4ES	7222	0,7	BPR4EVX		3436			
BSA												
A 7	500	47 -	62	B7HCS	2421	0,7						
BSM												
City	50	99 -	01	BPR7HS	6422	0,6	BPR7HVX	2938	215	BPR7HIX	5944	
Off Road	50	99 -	01	BPR7HS	6422	0,6	BPR7HVX	2938	215	BPR7HIX	5944	
Thunderbike	50	99 -		BPR7HS	6422	0,6	BPR7HVX	2938	215	BPR7HIX	5944	
Winner	50	99 -		BPR7HS	6422	0,6	BPR7HVX	2938	215	BPR7HIX	5944	
Thunderbike 2	100	99 -		BPR7HS	6422	0,6	BPR7HVX	2938	215	BPR7HIX	5944	
125	125	99 -		DR8EA	7162	0,7	DR8EVX	6354		DR8EIX	6681	
Thunderbike 4	125	99 -		CR7HSA	4549	0,7				CR7HIX	7544	
BUELL												
RR 1000	1000	87 -	88	DCPR7E	3932	1,0	DCPR7EVX	1179		DCPR7EIX	6046	
XB9R	1000	01 -		DCPR9E	2641	0,9	DCPR9EVX	6436		DCPR9EIX	2316	
XB9S	1000	03 -		DCPR9E	2641	0,9	DCPR9EVX	6436		DCPR9EIX	2316	
XB9S	1000	05 -		DCPR9E	2641	0,9	DCPR9EVX	6436		DCPR9EIX	2316	
XB9SX	1000	05 -		DCPR9E	2641	0,9	DCPR9EVX	6436		DCPR9EIX	2316	
M2 Cyclone	1200	97 -	98	DCPR7E	3932	1,0	DCPR7EVX	1179		DCPR7EIX	6046	
RSS 1200/ RS/ RR	1200	89 -	94	DCPR7E	3932	1,0	DCPR7EVX	1179		DCPR7EIX	6046	
S1 Lightning	1200	96 -	97	DCPR7E	3932	1,0	DCPR7EVX	1179		DCPR7EIX	6046	
S1 White Lightning	1200	98 -		DCPR7E	3932	1,0	DCPR7EVX	1179		DCPR7EIX	6046	
S2 Thunderbolt	1200	95 -	96	DCPR7E	3932	1,0	DCPR7EVX	1179		DCPR7EIX	6046	
S3 Thunderbolt	1200	97 -		DCPR7E	3932	1,0	DCPR7EVX	1179		DCPR7EIX	6046	
X1 Lightning	1200	99 -		DCPR7E	3932	1,0	DCPR7EVX	1179		DCPR7EIX	6046	
XB 12 S	1200	04 -		DCPR9E	2641	0,9	DCPR9EVX	6436		DCPR9EIX	2316	
BULTACO												
49/GT	50			B5HS	4210	0,5						
Astro	50	98 -		B9ES	2611	0,5	B9EVX	7254	202	BR9EIX	3981	
Chispa	50			B5HS	4210	0,5						
Lobito	50	98 -		B9ES	2611	0,5	B9EVX	7254	202	BR9EIX	3981	
Tiron	50			B5HS	4210	0,5						
Brinco	75			B7HS	5110	0,5	B7HVX	7836	204	BR7HIX	7067	
Frontera	75			B8HS	5510	0,5	B8HVX	2634	205	BR8HIX	7001	
Junior GT2	75			B7HS	5110	0,5	B7HVX	7836	204	BR7HIX	7067	
Lobito	75			B6HS	4510	0,5	B6HVX	7435	203	BR6HIX	3419	
Sherpa T	75			B6HS	4510	0,5	B6HVX	7435	203	BR6HIX	3419	
Streaker	75			B6HS	4510	0,5	B6HVX	7435	203	BR6HIX	3419	
Junior	100			B6HS	4510	0,5	B6HVX	7435	203	BR6HIX	3419	



Order No.



Gold-Palladium

Platin



Order No.

Quick-No.







Iridium



Order No.

BULTACO

Lobito	100		B6HS	4510	0,5	B6HVX	7435	203	BR6HIX	3419
Lobito K	100		B9HS	5810	0,5	B9HVX	2254			
Sherpa S	100		B9HS	5810	0,5	B9HVX	2254			
Tiron	100		B6HS	4510	0,5	B6HVX	7435	203	BR6HIX	3419
Alpina	125		BP5ES	6511	0,5	BP5EVX	5470		BPR5EIX	6597
Frontera	125		B6HS	4510	0,5	B6HVX	7435	203	BR6HIX	3419
Junior	125		B6HS	4510	0,5	B6HVX	7435	203	BR6HIX	3419
Lobito MK3/MK6	125		BP5ES	6511	0,5	BP5EVX	5470		BPR5EIX	6597
Lobito MK7	125		B6HS	4510	0,5	B6HVX	7435	203	BR6HIX	3419
Mercurio	125		B6HS	4510	0,5	B6HVX	7435	203	BR6HIX	3419
Pursang MK5	125		B10EG	3630	0,5	B10EGV	5927			
Pursang MK6	125		B9EG	3530	0,5	B9EGV	5827		BR9EIX	3981
Sherco	125	00 -	BPR5ES	7422	0,6	BPR5EVX	4875		BPR5EIX	6597
Sherpa S	125		B9EG	3530	0,5	B9EGV	5827		BR9EIX	3981
Sherpa T	125		B6HS	4510	0,5	B6HVX	7435	203	BR6HIX	3419
Streaker	125		B6HS	4510	0,5	B6HVX	7435	203	BR6HIX	3419
Tralla	125		B6HS	4510	0,5	B6HVX	7435	203	BR6HIX	3419
Campera	150		B6HS	4510	0,5	B6HVX	7435	203	BR6HIX	3419
Mercurio/GT/150	150		B6HS	4510	0,5	B6HVX	7435	203	BR6HIX	3419
Tralla	150		B6HS	4510	0,5	B6HVX	7435	203	BR6HIX	3419
Alpina	175		BP5ES	6511	0,5	BP5EVX	5470		BPR5EIX	6597
Campera MK2	175		B5ES	6410	0,5					
Lobito MK6	175		BP5ES	6511	0,5	BP5EVX	5470		BPR5EIX	6597
Lobito MK7	175		B5ES	6410	0,5					
Mercurio	175		B6HS	4510	0,5	B6HVX	7435	203	BR6HIX	3419
Mercurio GT	175		BP5ES	6511	0,5	BP5EVX	5470		BPR5EIX	6597
Pursang MK5	175		B9EG	3530	0,5	B9EGV	5827		BR9EIX	3981
Sherpa MK3	175		B9EG	3530	0,5	B9EGV	5827		BR9EIX	3981
El Tigre	200		B8ES	2411	0,5	B8EVX	7051	201	BR8EIX	5044
Go Kart	200		B9EG	3530	0,5	B9EGV	5827		BR9EIX	3981
Mercurio	200		B8ES	2411	0,5	B8EVX	7051	201	BR8EIX	5044
Metise	200		B8ES	2411	0,5	B8EVX	7051	201	BR8EIX	5044
Pursang MK5	200		B9EG	3530	0,5	B9EGV	5827		BR9EIX	3981
Senior	200		B8ES	2411	0,5	B8EVX	7051	201	BR8EIX	5044
Sherco	200	00 -	BPR5ES	7422	0,6	BPR5EVX	4875		BPR5EIX	6597
Sherpa MK3	200		B9EG	3530	0,5	B9EGV	5827		BR9EIX	3981
Sherpa S	200		B7ES	1111	0,5	B7EVX	6934			
Alpina	250		BP5ES	6511	0,5	BP5EVX	5470		BPR5EIX	6597
Astro	250		B9EG	3530	0,5	B9EGV	5827		BR9EIX	3981
Frontera	250		B8ES	2411	0,5	B8EVX	7051	201	BR8EIX	5044
Matador 250/SD	250		BP5ES	6511	0,5	BP5EVX	5470		BPR5EIX	6597
Matador MK2/MK3	250		B8ES	2411	0,5	B8EVX	7051	201	BR8EIX	5044
Matador MK4	250		BP6ES	7811	0,5	BP6EVX	5832		BPR6EIX	6637
Metrala GT/MK2/MK250	250		B8ES	2411	0,5	B8EVX	7051	201	BR8EIX	5044
Metrala GTS	250		BP5ES	6511	0,5	BP5EVX	5470		BPR5EIX	6597
Pursang MK4/MK5 lado admis	250		B8ES	2411	0,5	B8EVX	7051	201	BR8EIX	5044
Pursang MK4/MK5 lado escap	250		B9EG	3530	0,5	B9EVX	7254		BR9EIX	3981
Pursang MK6/MK7 lado admis	250		B8ES	2411	0,5	B8EGV	5627	201	BR8EIX	5044
Pursang MK6/MK7 lado escap	250		B9EG	3530	0,5	B9EGV	5827		BR9EIX	3981
Sherco	250	99 -	BPR5ES	7422	0,6	BPR5EVX	4875		BPR5EIX	6597
Sherpa S	250		B9EG	3530	0,5	B9EGV	5827		BR9EIX	3981
Sherpa T	250		BP5ES	6511	0,5	BP5EVX	5470		BPR5EIX	6597

					Order No.		Platin 	Order No.	Quick-No.	Iridium 	Order No.
BULTACO											
Sherco	290	00 -	BPR5ES	7422	0,6	BPR5EVX	4875			BPR5EIX	6597
Alpina	350		BP5ES	6511	0,5	BP5EVX	5470			BPR5EIX	6597
Matador MK9/MK10	350		BP5ES	6511	0,5	BP5EVX	5470			BPR5EIX	6597
Pursang MK5/MK6 lado admis	350		B8ES	2411	0,5	B8EVX	7051	201		BR8EIX	5044
Pursang MK5/MK6 lado escap	350		B9EG	3530	0,5	B9EGV	5827			BR9EIX	3981
Sherpa T	350		BP5ES	6511	0,5	BP5EVX	5470			BPR5EIX	6597
Astro lado admision	360		B8ES	2411	0,5	B8EVX	7051	201		BR8EIX	5044
Astro lado escape	360		B9EG	3530	0,5	B9EGV	5827			BR9EIX	3981
El Bandito MK2 lado admis.	360		B8ES	2411	0,5	B8EVX	7051	201		BR8EIX	5044
El Bandito MK2 lado escape	360		B9EG	3530	0,5	B9EGV	5827			BR9EIX	3981
Frontera	360		B8ES	2411	0,5	B8EVX	7051	201		BR8EIX	5044
Pursang lado admision	360		B8ES	2411	0,5	B8EVX	7051	201		BR8EIX	5044
Pursang lado escape	360		B9EG	3530	0,5	B9EGV	5827			BR9EIX	3981
Frontera MK11	370		B8ES	2411	0,5	B8EVX	7051	201		BR8EIX	5044
Pursang lado admision	370		B8ES	2411	0,5	B8EVX	7051	201		BR8EIX	5044
Pursang lado escape	370		B9EG	3530	0,5	B9EGV	5827			BR9EIX	3981
Pursang MK15	450		B8ES	2411	0,5	B8EVX	7051	201		BR8EIX	5044
CAGIVA											
City	50	98 -	BR8HSA	5539	0,5	BR8HVX	6265			BR8HIX	7001
Cocis	50		B8ES	2411	0,5	B8EVX	7051	201		BR8EIX	5044
K3	50		B8ES	2411	0,5	B8EVX	7051	201		BR8EIX	5044
Prima	50		B8ES	2411	0,5	B8EVX	7051	201		BR8EIX	5044
Supercity	50		B8ES	2411	0,5	B8EVX	7051	201		BR8EIX	5044
W4	50		B8ES	2411	0,5	B8EVX	7051	201		BR8EIX	5044
Cocis	75		B8ES	2411	0,5	B8EVX	7051	201		BR8EIX	5044
125 Elefant 2	125		B9EG	3530	0,5	B9EGV	5827			BR9EIX	3981
Aletta Electra, Oro	125	84 -	B9ES	2611	0,5	B9EVX	7254	202		BR9EIX	3981
Aletta Oro 125/S1	125	07.85 -12.85	B9EG	3530	0,5	B9EGV	5827			BR9EIX	3981
Aletta Oro 125/S2	125	01.86 -	B9ES	2611	0,6	B9EVX	7254	202		BR9EIX	3981
Aletta, Low Rider	125	01.82 -	B8ES	2411	0,5	B8EVX	7051	201		BR8EIX	5044
Blues, C10, Cruiser	125	10.87 -	B9ES	2611	0,5	B9EVX	7254	202		BR9EIX	3981
Elefant 3	125	01.87 -	B9ES	2611	0,5	B9EVX	7254	202		BR9EIX	3981
Freccia C 9 (D)	125	06.87 -	B9ES	2611	0,6	B9EVX	7254	202		BR9EIX	3981
Freccia C10 (D)	125		B9ES	2611	0,6	B9EVX	7254	202		BR9EIX	3981
Freccia C12 (D)	125	06.87 -	B9ES	2611	0,6	B9EVX	7254	202		BR9EIX	3981
K7	125				0,5	B95EGV	2145				
Mito	125	95 - 98			0,5	B95EGV	2145				
Mito	125	99 -	BR9EG	3230	0,5						
Mito 1 (D)	125				0,5	B95EGV	2145				
Mito 2 (D)	125				0,5	B95EGV	2145				
Mito EV 125	125		BR10EG	3830	0,6						
Mito Racing (D)	125				0,5	B95EGV	2145				
N 90	125	03.90 -	B9ES	2611	0,5	B9EVX	7254	202		BR9EIX	3981
Passing (Roller)	125	94 -	BP6HS	4511	0,6	BP6HVX	4635			BPR6HIX	4085
Planet	125	99 - 03	BR9EG	3230	0,5						
RL, SS, SX	125		B8ES	2411	0,5	B8EVX	7051	201		BR8EIX	5044
Roadster	125	98 -	BR9ES	5722	0,6	BR9EVX	1265	208		BR9EIX	3981
Aletta Rossa / Dakar	125		B9EG	3530	0,5	B9EGV	5827			BR9EIX	3981
RX 125 Rally	125	01.81 -12.81	B9EG	3530	0,5	B9EGV	5827			BR9EIX	3981
RX, WRX, WSXT	125	01.82 -12.83	B9EG	3530	0,5	B9EGV	5827			BR9EIX	3981
ST, SXT	125	01.82 -12.82	B9ES	2611	0,5	B9EVX	7254	202		BR9EIX	3981



Order No.



Gold-Palladium



Platin

Order No.



Quick-No.

Iridium









Order No.







CAGIVA







Supercity	125	99 -	BR9EG	3230	0,5					
Supercity (D)	125				0,5	B95EGV	2145			
Tamanaco 125	125	01.88 -	B9ES	2611	0,6	B9EVX	7254	202	BR9EIX	3981
W 8 (only D)	125	91 -			0,5	B95EGV	2145			
W 8	125	98 -	BR9ES	5722	0,6	BR9EVX	1265	208	BR9EIX	3981
W 8 11kW	125	96 - 97	B9ES	2611	0,5	B9EVX	7254	202	BR9EIX	3981
WMX 125/84	125				0,5	B9EVX	7254		BR9EIX	3981
WMX 125/85	125				0,5	B10EGV	5927			
WMX 125/88	125				0,5	B10EGV	5927			
WR 125	125	02 -	BR9EG	3230	0,5					
WRE 125	125	02 -	BR9EG	3230	0,5					
All	175		B8ES	2411	0,5	B8EVX	7051	201	BR8EIX	5044
All	200		B9ES	2611	0,5	B9EVX	7254	202	BR9EIX	3981
MX,MXR,RR,RX,WMX	250		B9ES	2611	0,5	B9EVX	7254	202	BR9EIX	3981
NC,RL,SS,SST	250	01.83 -	B8ES	2411	0,5	B8EVX	7051	201	BR8EIX	5044
RX 250 Rally	250	01.79 - 11.83	B9EG	3530	0,5	B9EGV	5827		BR9EIX	3981
SX, SXT	250	01.83 - 12.84	B8ES	2411	0,5	B8EVX	7051	201	BR8EIX	5044
Ala Blu 350	350		B8ES	2411	0,5	B8EVX	7051	201	BR8EIX	5044
Ala Rossa 350/4T	350	01.83 -	B8ES	2411	0,5	B8EVX	7051	201	BR8EIX	5044
Ala Verde 350	350		B8ES	2411	0,5	B8EVX	7051	201	BR8EIX	5044
Alazzurra 350 (D)	350	01.84 -	BP7HS	5111	0,5	BP7HVX	7468		BPR7HIX	5944
Elefant 350 (D)	350		BP7HS	5111	0,5	BP7HVX	7468		BPR7HIX	5944
Lucky 350	350		DP8EA-9	5829	0,9	DPR8EVX-9	2872		DPR8EIX-9	2202
SST 350	350		B8ES	2411	0,5	B8EVX	7051	201	BR8EIX	5044
SX 350	350	11.81 - 12.82	B8ES	2411	0,5	B8EVX	7051	201	BR8EIX	5044
T4 350 E, R (D)	350	10.86 -	DP8EA-9	5829	0,9	DPR8EVX-9	2872		DPR8EIX-9	2202
Trial 350	350	01.82 -	BP5ES	6511	0,6	BP5EVX	5470		BPR5EIX	6597
W12	350	94 -	DP8EA-9	5829	0,9	DPR8EVX-9	2872		DPR8EIX-9	2202
T4 500 E, R (D)	450		DP8EA-9	5829	0,9	DPR8EVX-9	2872		DPR8EIX-9	2202
Canyon 500	500	98 -	BPR8ES	3923	0,7	BPR8EVX	5573	213		
MXR 500	500				0,5	B95EGV	2145			
Canyon 600	600	98 -	BCP7ES	5030	0,8	BCP7EV	3733			
Canyon 600	600	96 - 97			0,7	BKR7EVX	3544			
River 600	600	95 -			0,7	BKR7EVX	3544			
Super City	600	95 -			0,7	BKR7EVX	3544			
W16	600	94 -			0,7	BKR7EVX	3544			
Alazzurra 650 (D)	650	01.84 -	BP7HS	5111	0,6	BP7HVX	7468		BPR7HIX	5944
Elefant 650 (D)	650	01.85 - 12.88	BP7HS	5111	0,6	BP7HVX	7468		BPR7HIX	5944
Raptor	650	00 -	CR8E	1275	0,7	CR8EVX	6487	226	CR8EIX	4218
V-Raptor	650	00 -	CR8E	1275	0,7	CR8EVX	6487	226	CR8EIX	4218
Elefant 750	750	94 -	DPR8EA-9	4929	0,9	DPR8EVX-9	2872	221	DPR8EIX-9	2202
Elefant 750 Lucky (D)	750	02.87 -	DPR8EA-9	4929	0,9	DPR8EVX-9	2872	221	DPR8EIX-9	2202
Elefant 900 AC (D)	900	93 -	DPR9EA-9	5329	0,9	DPR9EVX-9	3854	222	DPR9EIX-9	5545
Elefant 900 ie/GT (D)	900	92 -	DPR9EA-9	5329	0,9	DPR9EVX-9	3854	222	DPR9EIX-9	5545
Grand Canyon 900	900	98 -	DPR8EA-9	4929	0,9	DPR8EVX-9	2872	221	DPR8EIX-9	2202
Navigator 1000	1000	99 -	CR8EK	3478	0,7					
Raptor	1000	99 -	CR8EK	3478	0,7					
V-Raptor	1000	03.00 -	CR8EK	3478	0,7					
X-tra Raptor 1000	1000	03 -	CR8EK	3478	0,7					







CANNONDALE







EX 400	432	01 -	CR9EK	4548	0,7			230	CR9EIX	3521
--------	-----	------	-------	------	-----	--	--	-----	--------	------

					Order No.		Platin 	Order No.	Quick-No.	Iridium 	Order No.
CANNONDALE											
FX 400 (ATV)	432	00 -	CR9EK	4548	0,7				230	CR9EIX	3521
MX 400	432	00 -	CR9EK	4548	0,7				230	CR9EIX	3521
XC 400	432	01 -	CR9EK	4548	0,7				230	CR9EIX	3521
440 Moto (ATV)	440	02 -	CR9EK	4548	0,7				230	CR9EIX	3521
Blaze (ATV)	440	02 -	CR9EK	4548	0,7				230	CR9EIX	3521
Cannibal (ATV)	440	02 -	CR9EK	4548	0,7				230	CR9EIX	3521
Glamis (ATV)	440	03 -	CR9EK	4548	0,7				230	CR9EIX	3521
Speed (ATV)	440	02 -	CR9EK	4548	0,7				230	CR9EIX	3521
CARABELA											
Carrera	50		BP5HS	4111	0,5						
Super SP / de Luxe	50		BP5HS	4111	0,5						
Ciclo Motor Ciao	60		B6HS	4510	0,5	B6HVX	7435	203	BR6HIX	3419	
Merida, Mototic, Motopony	60		B6HS	4510	0,5	B6HVX	7435	203	BR6HIX	3419	
Coyote Enduro	100		B6ES	7310	0,5	B6EVX	5136				
Coyote MX	100		B7ES	1111	0,6	B7EVX	6934				
Enduro ,MX	100		B6HS	4510	0,5	B6HVX	7435	203	BR6HIX	3419	
Marquesa MX	100		B8ES	2411	0,6	B8EVX	7051	201	BR8EIX	5044	
Marquesa Enduro	100		B7ES	1111	0,6	B7EVX	6934				
Marquesa Mini Enduro	100		B6ES	7310	0,5	B6EVX	5136				
Marquesa Mini MX	100		B7ES	1111	0,6	B7EVX	6934				
Mini Moto	100		B6ES	7310	0,5	B6EVX	5136				
Motorcarro 100	100		B6ES	7310	0,5	B6EVX	5136				
Panthera	100		B6HS	4510	0,5	B6HVX	7435	203	BR6HIX	3419	
Panthera100,Sprint 100, TS-3 100	100		B6ES	7310	0,5	B6EVX	5136				
Rally Enduro	100		B6ES	7310	0,5	B6EVX	5136				
Torero Flat Track	100		B8ES	2411	0,6	B8EVX	7051	201	BR8EIX	5044	
Coyote Enduro	125		B6ES	7310	0,5	B6EVX	5136				
Coyote MX	125		B7ES	1111	0,6	B7EVX	6934				
De Luxe	125		B6ES	7310	0,5	B6EVX	5136				
Marquesa MX 111	125		B8ES	2411	0,6	B8EVX	7051	201	BR8EIX	5044	
Marquesa MXV	125		B8ES	2411	0,6	B8EVX	7051	201	BR8EIX	5044	
Mini Enduro	125		B6ES	7310	0,5	B6EVX	5136				
Rally Enduro	125		B6ES	7310	0,5	B6EVX	5136				
Torero Flat Track	125		B8ES	2411	0,6	B8EVX	7051	201	BR8EIX	5044	
Marquesa Enduro	175		B8ES	2411	0,6	B8EVX	7051	201	BR8EIX	5044	
Marquesa MK-II	175		B8ES	2411	0,6	B8EVX	7051	201	BR8EIX	5044	
Rally Enduro	175		B6ES	7310	0,5	B6EVX	5136				
Strada	175		B6ES	7310	0,5	B6EVX	5136				
Torero Flat Track	175		B8ES	2411	0,6	B8EVX	7051	201	BR8EIX	5044	
Enduro	200		B6ES	7310	0,5	B6EVX	5136				
Moto Cross	200		B8ES	2411	0,6	B8EVX	7051	201	BR8EIX	5044	
Motocarro Ariete	200		B6ES	7310	0,5	B6EVX	5136				
Super Turismo	200		B6ES	7310	0,5	B6EVX	5136				
Centauro Enduro	250		B8ES	2411	0,6	B8EVX	7051	201	BR8EIX	5044	
Centauro MX-II, MX-III, MX-IV	250		B8ES	2411	0,6	B8EVX	7051	201	BR8EIX	5044	
Torero Flat Track	250		B8ES	2411	0,6	B8EVX	7051	201	BR8EIX	5044	
Centauro MX-III	360		B8ES	2411	0,6	B8EVX	7051	201	BR8EIX	5044	
Enduro	400		B6ES	7310	0,5	B6EVX	5136				
MX	400		B8ES	2411	0,6	B8EVX	7051	201	BR8EIX	5044	
Centauro MX-II	450		B8ES	2411	0,6	B8EVX	7051	201	BR8EIX	5044	
Enduro	450		B6ES	7310	0,5	B6EVX	5136				

				Order No.		Platin 	Order No.	Quick-No.	Iridium 	Order No.
CARABELA										
Torero Flat Track	450		B7ES	1111	0,6	B7EVX	6934			
CARREFOUR										
Web / Gap	50	00 -	B7HS	5110	0,5	B7HVX	7836	204	BR7HIX	7067
PFM	125	00 -	DR8EA	7162	0,7	DR8EVX	6354		DR8EIX	6681
CASAL										
M 105 Six Speed (RZ,Mag.)	50	92 -	B9HS	5810	0,6	B9HVX	2254			
M 109 Four Speed	50	91 -	B8HS	5510	0,6	B8HVX	2634	205	BR8HIX	7001
M 140 Automatic	50	82 -	B7HS	5110	0,6	B7HVX	7836	204	BR7HIX	7067
M 147 Two Speed	50	91 -	B7HS	5110	0,6	B7HVX	7836	204	BR7HIX	7067
M 233 Six Speed	50	90 -	B8ES	2411	0,6	B8EVX	7051	201	BR8EIX	5044
Super Boss K 168-8	50	91 -	B8HS	5510	0,6	B8HVX	2634	205	BR8HIX	7001
CCM										
CMX 125 L / C	125	83 - 85	B9EG	3530	0,5	B9EGV	5827		BR9EIX	3981
Moto X Hiro	125	79 - 80	B10EG	3630	0,5	B10EGV	5927			
240 CMT Trails	240		BP5ES	6511	0,7	BP5EVX	5470		BPR5EIX	6597
250 CMT Trails	250		BP5ES	6511	0,7	BP5EVX	5470		BPR5EIX	6597
250 CMX	250	82 -	B8ES	2411	0,5	B8EVX	7051	201	BR8EIX	5044
250 CMX I / C	250	83 - 85	B9EG	3530	0,5	B9EGV	5827		BR9EIX	3981
250 Moto Hiro	250	79 - 81	B9EG	3530	0,5	B9EGV	5827		BR9EIX	3981
310 CMT Trails	310		BP5ES	6511	0,7	BP5EVX	5470		BPR5EIX	6597
320 CMT Trails	320		BP5ES	6511	0,7	BP5EVX	5470		BPR5EIX	6597
350 CMT Trails	350		BP5ES	6511	0,7	BP5EVX	5470		BPR5EIX	6597
350 Trails	350	78 -	B6ES	7310	0,7	B6EVX	5136			
CM 36 Road Racer	350	78 -			0,5	B9EVX	7254	202	BR9EIX	3981
CMX	450	82 -			0,5	B8EVX	7051		BR8EIX	5044
490 CMX	490		B9EG	3530	0,5	B9EGV	5827		BR9EIX	3981
500 MTT	500		DR8EA	7162	0,7	DR8EVX	6354		DR8EIX	6681
CMX 500	500	82 -	DR8EA	7162	0,7	DR8EVX	6354		DR8EIX	6681
Moto X 2Ventil	500	72 - 79	B9EG	3530	0,5	B9EGV	5827		BR9EIX	3981
Moto X 4Ventil	500	79 - 81	R017-8	3943	0,5				CR8EIX	4218
560 CCM 2Takt	560		DR8EA	7162	0,7	DR8EVX	6354		DR8EIX	6681
560 CCM 4Takt	560		DR8EA	7162	0,7	DR8EVX	6354		DR8EIX	6681
604 R / RS / R30	600		DR8EA	7162	0,7	DR8EVX	6354		DR8EIX	6681
604 Roadster RS	600	01 -	DR8EA	7162	0,7	DR8EVX	6354		DR8EIX	6681
604 Trail dual Sport	600	01 -	DR8EA	7162	0,7	DR8EVX	6354		DR8EIX	6681
604 Supermoto dual Sport	600	01 -	DR8EA	7162	0,7	DR8EVX	6354		DR8EIX	6681
640 RS	640		DR8EA	7162	0,7	DR8EVX	6354		DR8EIX	6681
644	650	02 -	CR10EK	2360	0,7				CR10EIX	6482
R30	650	02 -	CR9EK	4548	0,7		230		CR9EIX	3521
CLIPIC										
Trial	50	00 -	B7HS	5110	0,5	B7HVX	7836	204	BR7HIX	7067
Trial E	50	00 -	B10ES	7928	0,5	B10EVX	7335		BR10EIX	6801
Trial R	80	00 -	B9ES	2611	0,5	B9EVX	7254	202	BR9EIX	3981
COSSACK										
Jupiter 350	350		BR6HS	3922	0,5		209		BR6HIX	3419
Planeta 350	350		BR6HS	3922	0,5		209		BR6HIX	3419
Dnepr 650	650		BR6HS	3922	0,5		209		BR6HIX	3419

					Order No.		Gold-Palladium	Platin 	Order No.	Quick-No.	Iridium 	Order No.
COSSACK												
Ural 650, Ural MT10	650		B6HS	4510	0,5	B6HVX	7435	203	BR6HIX	3419		
CPI												
200 (ATV)	50	03 -	BR7ES	5122	0,8	BR7EVX	4556					
Carb 50 (ATV)	50	03 -	BR8HSA	5539	0,8	BR8HVX	6265		BR8HIX	7001		
Supercross 50	50	03 -	BR7ES	5122	0,8	BR7EVX	4556					
Supermoto 50	50	03 -	BR7ES	5122	0,8	BR7EVX	4556					
Carb 100 (ATV)	100	03 -	BR8HSA	5539	0,8	BR8HVX	6265		BR8HIX	7001		
CRAZY-VEHICLE												
Crazy Buggy	125	03 -	CR7HSA	4549	0,7				CR7HIX	7544		
CZ												
488	125		B6HS	4510	0,6	B6HVX	7435	203	BR6HIX	3419		
487	175		B6HS	4510	0,6	B6HVX	7435	203	BR6HIX	3419		
485	250		B6HS	4510	0,6	B6HVX	7435	203	BR6HIX	3419		
472	350		B6HS	4510	0,6	B6HVX	7435	203	BR6HIX	3419		
DAELIM												
125 Daystar	125	01.00 -	C8EH-9	7473	0,9	C8EHVX-9	4450		CR8EHIX-9	3797		
Altino 125 ES	125	02 -	C8EH-9	7473	0,9	C8EHVX-9	4450		CR8EHIX-9	3797		
Evolution VS	125	02 -	C8EH-9	7473	0,9	C8EHVX-9	4450		CR8EHIX-9	3797		
VC 125 Advance	125	95 -	C8EH-9	7473	0,9	C8EHVX-9	4450		CR8EHIX-9	3797		
VL 125 Daystar	125	02 -	C8EH-9	7473	0,9	C8EHVX-9	4450		CR8EHIX-9	3797		
VL 125 L Daystar	125	02 -	C8EH-9	7473	0,9	C8EHVX-9	4450		CR8EHIX-9	3797		
VT 125 Evolution	125	03.98 -	C8EH-9	7473	0,9	C8EHVX-9	4450		CR8EHIX-9	3797		
DAREN												
50 (ATV)	50	00 -	BPR7HS	6422	0,8	BPR7HVX	2938	215	BPR7HIX	5944		
100 (ATV)	100	00 -	BPR7HS	6422	0,8	BPR7HVX	2938	215	BPR7HIX	5944		
125 (ATV)	125	00 -	DR8EA	7162	0,7	DR8EVX	6354		DR8EIX	6681		
150 (ATV)	150	00 -	DR8EA	7162	0,7	DR8EVX	6354		DR8EIX	6681		
DERBI												
Antorcha, Coppa, Diablo	50	- 91	B7HS	5110	0,6	B7HVX	7836	204	BR7HIX	7067		
Aventura	50	95 -	B8HS	5510	0,6	B8HVX	2634	205	BR8HIX	7001		
Aventura	50	95 -	B8HS	5510	0,6	B8HVX	2634	205	BR8HIX	7001		
Dirt Boy 10/10	50	03 -	CR9E	6263	0,7	CR9EVX	5943	227	CR9EIX	3521		
Dirt Kid 10/12	50	03 -	CR9E	6263	0,7	CR9EVX	5943	227	CR9EIX	3521		
FDS, GTS, RD-2	50	- 91	B7HS	5110	0,6	B7HVX	7836	204	BR7HIX	7067		
Fenix, FDS Super, Start DS	50	92 -	B8HS	5510	0,6	B8HVX	2634	205	BR8HIX	7001		
Furax	50	95 -	B8HS	5510	0,6	B8HVX	2634	205	BR8HIX	7001		
GPR Replica	50	03 -	B8ES	2411	0,5	B8EVX	7051	201	BR8EIX	5044		
GPR Racing	50	02 -	B8ES	2411	0,5	B8EVX	7051	201	BR8EIX	5044		
GPR 50 R	50	02 -	B8ES	2411	0,5	B8EVX	7051	201	BR8EIX	5044		
Hunter (D+A)	50	95 -	BP7HS	5111	0,6	BP7HVX	7468		BPR7HIX	5944		
Hunter (Spain)	50	95 -	B8HS	5510	0,6	B8HVX	2634	205	BR8HIX	7001		
Naked	50	04 -	B8ES	2411	0,5	B8EVX	7051	201	BR8EIX	5044		
Olimpica, Savanah, Start	50	- 91	B7HS	5110	0,6	B7HVX	7836	204	BR7HIX	7067		
R DRD	50	02 -	B8ES	2411	0,5	B8EVX	7051	201	BR8EIX	5044		
R Racer	50	02 -	B8ES	2411	0,5	B8EVX	7051	201	BR8EIX	5044		
R X-treme	50	02 -	B8ES	2411	0,5	B8EVX	7051	201	BR8EIX	5044		

				Order No.		Platin 	Order No.	Quick-No. 	Iridium 	Order No.
DERBI										
RD-2 Country	50	92 -	B8HS	5510	0,6	B8HVX	2634	205	BR8HIX	7001
Senda (Wasserkühlung)	50	-	B8ES	2411	0,5	B8EVX	7051	201	BR8EIX	5044
Sendra-R	50	95 -	B9ES	2611	0,6	B9EVX	7254	202	BR9EIX	3981
SM Black Edition	50	02 -	B8ES	2411	0,5	B8EVX	7051	201	BR8EIX	5044
SM DRD	50	-	B9ES	2611	0,6	B9EVX	7254	202	BR9EIX	3981
SM Racer	50	02 -	B9ES	2611	0,6	B9EVX	7254	202	BR9EIX	3981
SM X-treme	50	02 -	B9ES	2611	0,6	B9EVX	7254	202	BR9EIX	3981
Sport, Variant, Yumbo	50	- 91	B7HS	5110	0,6	B7HVX	7836	204	BR7HIX	7067
Urban	50	95 -	B8HS	5510	0,6	B8HVX	2634	205	BR8HIX	7001
Vamos	50	-	BR8HS	4322	0,6	BR8HVX	6265	212	BR8HIX	7001
Variant Box/Sport R / Top	50	92 -	B8HS	5510	0,6	B8HVX	2634	205	BR8HIX	7001
Variant AIR	50	05.03 -	B8HS	5510	0,5	B8HVX	2634	205	BR8HIX	7001
1001,Extra Sport Coppa	75		B8ES	2411	0,5	B8EVX	7051	201	BR8EIX	5044
CR 74	75				0,5	B10EGV	5927			
Europa RD15, Scoot 74	75		B8ES	2411	0,5	B8EVX	7051	201	BR8EIX	5044
GPR-75, Sport-75	75		B10ES	7928	0,5	B10EGV	5927		BR10EIX	6801
Gran Prix 74	75		B6HS	4510	0,5	B6HVX	7435	203	BR6HIX	3419
Vivo-75	75		BP5HS	4111	0,6					
BI 3	80	95 -	B8ES	2411	0,6	B8EVX	7051	201	BR8EIX	5044
CRS, RC	125				0,5	B10EGV	5927			
Enduro, RS125TT, Karmathan	125				0,5	B9EGV	5827			
Senda R 125	125	02 -	DPR8EA-9	4929	0,9	DPR8EVX-9	2872	221	DPR8EIX-9	2202
Senda SM 125	125	02 -	DPR8EA-9	4929	0,9	DPR8EVX-9	2872	221	DPR8EIX-9	2202
Sport Coppa, TTS9	125		B9ES	2611	0,5	B9EVX	7254	202	BR9EIX	3981
170 (ATV)	170		DR8EA	7162	0,7	DR8EVX	6354		BR8EIX	6681
2002, Gran Prix, 6V	200		B9ES	2611	0,5	B9EVX	7254	202	BR9EIX	3981
250 (ATV)	250		CR8HS	7423	0,7	CR8HVX	7236		CR8HIX	7669
CRX, RC, Enduro	250				0,5	B10EGV	5927			
Turismo 250	250		B9ES	2611	0,5	B9EVX	7254	202	BR9EIX	3981
DKW										
RT 175	175	59 -	B7HS	5110	0,5	B7HVX	7836	204	BR7HIX	7067
RT 250	175	59 -	B7HS	5110	0,5	B7HVX	7836	204	BR7HIX	7067
DNEPR										
11 J Gespann 28Kw	650		BP6HS	4511	0,6					
16 J Gespann 28Kw	650		BP6HS	4511	0,6					
KM3-8.157	650		BP6ES	7811	0,7	BP6EVX	5832		BPR6EIX	6637
KM3-8.157-022	650		BP6ES	7811	0,7	BP6EVX	5832		BPR6EIX	6637
MT 11 20KW	650		BP6HS	4511	0,6					
MT 16 20KW	650		BP6HS	4511	0,6					
DRR										
DRR 50 (ATV)	50	04 -	BP7HS	5111	0,7	BP7HVX	7468		BPR7HIX	5944
DRR 90 (ATV)	90	04 -	BP7HS	5111	0,7	BP7HVX	7468		BPR7HIX	5944
DRR 90 GT (ATV)	90	04 -	C7HSA	4629	0,7	C7HVX	4533		CR7HIX	7544
DUCATI										
100 Sport	100	58 - 60	B7HS	5110	0,6	B7HVX	7836	204	BR7HIX	7067
125 Scrambler	125	71 -	B8HS	5510	0,5	B8HVX	2634	205	BR8HIX	7001
125 Sport	125	58 - 65	B7HS	5110	0,6	B7HVX	7836	204	BR7HIX	7067
125 TS	125	59 - 65	B6HS	4510	0,5	B6HVX	7435	203	BR6HIX	3419

					Order No.		Platin 	Order No.	Quick-No.	Iridium 	Order No.
DUCATI											
160 Monza	160		B7HS	5110	0,6	B7HVX	7836	204	BR7HIX		7067
175 Sport	175	58 - 61	B7HS	5110	0,6	B7HVX	7836	204	BR7HIX		7067
175 TS	175	58 - 60	B6HS	4510	0,5	B6HVX	7435	203	BR6HIX		3419
200 Elite	200	59 - 65	B7HS	5110	0,6	B7HVX	7836	204	BR7HIX		7067
250 Mach 1	250	64 - 66	B7HS	5110	0,6	B7HVX	7836	204	BR7HIX		7067
250 Monza	250	68 -	B7HS	5110	0,6	B7HVX	7836	204	BR7HIX		7067
250 SCR	250	68 - 74	B7HS	5110	0,6	B7HVX	7836	204	BR7HIX		7067
250 SCR-MC	250	62 - 67	B7HS	5110	0,6	B7HVX	7836	204	BR7HIX		7067
350 Desmo	350	70 - 76	B6HS	4510	0,5	B6HVX	7435	203	BR6HIX		3419
350 F3	350	86 - 87	B6HS	4510	0,5	B6HVX	7435	203	BR6HIX		3419
350 F3 Desmo	350		BP7HS	5111	0,5	BP7HVX	7468		BPR7HIX		5944
350 Forza	350		B6HS	4510	0,5	B6HVX	7435	203	BR6HIX		3419
350 GTL	350	79 -	B6HS	4510	0,5	B6HVX	7435	203	BR6HIX		3419
350 Indiana	350	86 -	BR7HS	4122	0,5		211		BR7HIX		7067
350 Junior	350	92 -	BP7HS	5111	0,6	BP7HVX	7468		BPR7HIX		5944
350 MK III	350	70 - 76	B6HS	4510	0,5	B6HVX	7435	203	BR6HIX		3419
350 MK III D	350		B6HS	4510	0,5	B6HVX	7435	203	BR6HIX		3419
350 Sebring	350	65 - 68	B7HS	5110	0,6	B7HVX	7836	204	BR7HIX		7067
350 Sport	350	92 -	BP5ES	6511	0,7	BP5EVX	5470		BPR5EIX		6597
350 Sport Desmo	350		BR7HS	4122	0,5		211		BR7HIX		7067
350 Vento	350	80 -	B6HS	4510	0,5	B6HVX	7435	203	BR6HIX		3419
XL 350	350		BPR7HS	6422	0,6	BPR7HVX	2938	215	BPR7HIX		5944
400 Supersport Junior (D)	400	91 -	BPR7HS	6422	0,6	BPR7HVX	2938	215	BPR7HIX		5944
Monster 400	400	03 -	DCPR8E	4339	0,9	DCPR8EVX	2265		DCPR8EIX		6546
450 /Scrambler (D)	450	70 - 76	B6HS	4510	0,5	B6HVX	7435	203	BR6HIX		3419
450 Desmo Sport	450	71 - 74	BR7HS	4122	0,5		211		BR7HIX		7067
450 Mark 3D	450	69 - 71	BR7HS	4122	0,5		211		BR7HIX		7067
450 R/T	450	71 - 72	BR7HS	4122	0,5		211		BR7HIX		7067
450 SCR	450	69 - 74	B7HS	5110	0,6	B7HVX	7836	204	BR7HIX		7067
450 T/S	450	71 - 73	BR7HS	4122	0,5		211		BR7HIX		7067
500 GTL	500	74 - 79	B7HS	5110	0,5	B7HVX	7836	204	BR7HIX		7067
500 Pantah (D)	500	80 -	B7HS	5110	0,5	B7HVX	7836	204	BR7HIX		7067
500 SL Pantah (D)	500		BPR7HS	6422	0,6	BPR7HVX	2938	215	BPR7HIX		5944
500 Sport Desmo	500	79 - 83	B6HS	4510	0,5	B6HVX	7435	203	BR6HIX		3419
500 Sport Twin	500	78 -	B7HS	5110	0,5	B7HVX	7836	204	BR7HIX		7067
600 Monster	600	94 - 96	DCPR8E	4339	0,9	DCPR8EVX	2265		DCPR8EIX		6546
600 Pantah SL/TL (D)	600	81 -	BPR7HS	6422	0,6	BPR7HVX	2938	215	BPR7HIX		5944
600 SS	600	94 -	DCPR8E	4339	0,9	DCPR8EVX	2265		DCPR8EIX		6546
M 600 Monster all models	600	97 -	DCPR8E	4339	0,9	DCPR8EVX	2265		DCPR8EIX		6546
620 i.e.	620	02 -	DPR8EA-9	4929	0,9	DPR8EVX-9	2872	221	DPR8EIX-9		2202
620 i.e. Dark	620	02 -	DPR8EA-9	4929	0,9	DPR8EVX-9	2872	221	DPR8EIX-9		2202
620 S i.e.	620	02 -	DPR8EA-9	4929	0,9	DPR8EVX-9	2872	221	DPR8EIX-9		2202
620 Sport	620	03 -	DCPR8E	4339	0,9	DCPR8EVX	2265		DCPR8EIX		6546
M 620S i.e	620	01 -	DPR8EA-9	4929	0,9	DPR8EVX-9	2872	221	DPR8EIX-9		2202
M 620 i.e	620	01 -	DPR8EA-9	4929	0,9	DPR8EVX-9	2872	221	DPR8EIX-9		2202
650 Indiana	650	87 -	BP7HS	5111	0,6	BP7HVX	7468		BPR7HIX		5944
748 / SP/ SPS	748	95 -			0,6	DCPR9EVX	6436				
748 / Biposto	748	99 -			0,6	DCPR9EVX	6436				
748 R	748		R2270-9	4319		---			---		
748 S	748				0,6	DCPR9EVX	6436				
749 S 76kW	748	03 -		---		---			---		
749 R	750	04 -		---		---			---		



Order No.



Gold-Palladium

Platin



Order No.

Quick-No.







Iridium

















Order No.

DUCATI

750 SS i.e.	750	99 -	DPR8EA-9	4929	0,9	DPR8EVX-9	2872	221	DPR8EIX-9	2202
750 F1 Desmo	750	88 -	DCPR8E	4339	0,9	DCPR8EVX	2265		DCPR8EIX	6546
750 F1/LS (D)	750	85 -	DCPR8E	4339	0,9	DCPR8EVX	2265		DCPR8EIX	6546
750 GT	750	74 - 76	BPR7HS	6422	0,6	BPR7HVX	2938	215	BPR7HIX	5944
750 Indiana (D)	750	87 -	BPR7HS	6422	0,6	BPR7HVX	2938	215	BPR7HIX	5944
750 Monster	750	96 - 97	DCPR8E	4339	0,9	DCPR8EVX	2265		DCPR8EIX	6546
750 Paso (D)	750	86 -	DCPR8E	4339	0,9	DCPR8EVX	2265		DCPR8EIX	6546
750 Sport (D)	750	88 - 90	BPR7HS	6422	0,6	BPR7HVX	2938	215	BPR7HIX	5944
750 SS	750	91 -			0,6	DCPR9EVX	6436			
750 SS Königswelle	750	72 - 83	BPR7HS	6422	0,6	BPR7HVX	2938	215	BPR7HIX	5944
750 SS i.e.	750	99 -	DPR8EA-9	4929	0,9	DPR8EVX-9	2872	221	DPR8EIX-9	2202
M 750 Monster all models	750	97 -	DCPR8E	4339	0,6	DCPR8EVX	2265		DCPR8EIX	6546
SS 750 HF I.E.	750				0,6	DCPR9EVX	6436			
SS 750 I.E.	750				0,6	DCPR9EVX	6436			
800 Sport	800	03 -	DCPR8E	4339	0,9	DCPR8EVX	2265		DCPR8EIX	6546
800 SuperSport	800	03 -	DCPR8E	4339	0,9	DCPR8EVX	2265		DCPR8EIX	6546
Monster 800 i.e.	800	03 -	DCPR8E	4339	0,9	DCPR8EVX	2265		DCPR8EIX	6546
Monster S2R	803	05 -	DCPR8E	4339	0,9	DCPR8EVX	2265		DCPR8EIX	6546
851 S1 (D)	851	88 - 88			0,6	D9EVX	2834		DR9EIX	4772
851 S3 (D)	851	89 - 92			0,6	D9EVX	2834		DR9EIX	4772
860 Desmo SS (D)	860		B6HS	4510	0,5	B6HVX	7435	203	BR6HIX	3419
860 GT,GTS,S (D)	860	75 -	B6HS	4510	0,5	B6HVX	7435	203	BR6HIX	3419
851 S.P.,II,III,IV	888				0,6	D9EVX	2834		DR9EIX	4772
888 SP5	888	93 -	R2270-9	4319	0,5					
888 Strada	888	93 -			0,6	DCPR9EVX	6436			
900 S,SS,GTS,SD,S2,HR (D)	900	80 -	BP7HS	5111	0,6	BP7HVX	7468		BPR7HIX	5944
900 SS final edition	900	99 - 03	DPR8EA-9	4929	0,9	DPR8EVX-9	2872	221	DPR8EIX-9	2202
900 Super Sport (D)	900	88 - 90	DCPR8E	4339	0,9	DCPR8EVX	2265		DCPR8EIX	6546
900 SS / SL	900	91 - 98	DCPR8E	4339	0,9	DCPR8EVX	2265		DCPR8EIX	6546
907 I.E.	900	91 -	DCPR8E	4339	0,9	DCPR8EVX	2265		DCPR8EIX	6546
Darmah 900 (D)	900		B6HS	4510	0,6	B6HVX	7435	203	BR6HIX	3419
M 900 I.E.	900	99 -	DCPR8E	4339	0,9	DCPR8EVX	2265		DCPR8EIX	6546
M 900 Monster all models	900	97 -	DCPR8E	4339	0,9	DCPR8EVX	2265		DCPR8EIX	6546
MH 900 EVOLUZIONE (75PS)	900	00 -	DPR8EA-9	4929	0,9	DPR8EVX-9	2872	221	DPR8EIX-9	2202
Monster 900 Spezial (57kW)	900	00 -	DPR8EA-9	4929	0,9	DPR8EVX-9	2872	221	DPR8EIX-9	2202
Paso 906	900	88 - 90	DCPR8E	4339	0,9	DCPR8EVX	2265		DCPR8EIX	6546
Super Sport 900	900	91 - 92	DCPR8E	4339	0,9	DCPR8EVX	2265		DCPR8EIX	6546
900 SS I.E.	904	91 - 98	DCPR8E	4339	0,9	DCPR8EVX	2265		DCPR8EIX	6546
916 (non SP model)	916	94 -			0,6	DCPR9EVX	6436			
S 4	916	01 -	---			---			---	
S T 4	916	98 -			0,6	DCPR9EVX	6436			
S T 2	944	97 -	DCPR8E	4339	0,9	DCPR8EVX	2265		DCPR8EIX	6546
Mille (D)	972		BP7HS	5111	0,6	BP7HVX	7468		BPR7HIX	5944
916 SP / SPS	996	98 -	R2270-9	4319	0,5					
996 Biposto	996	99 -			0,6	DCPR9EVX	6436			
996 SP / SPS	996	98 -	R2270-9	4319	0,5					
S T 4 s	996				0,6	DCPR9EVX	6436			
996 R 99kW (H2)	998		---			---			---	
998	998	01 -	---			---			---	
998 (H2)	998	02 -	---			---			---	
998 R (H2)	998	02 -	---			---			---	
998 S (H2)	998	02 -	---			---			---	

				Order No.		Gold-Palladium	Platin 	Order No.	Quick-No.	Iridium 	Order No.
DUCATI											
999	998	05 -			0,6	DCPR9EVX	6436				
999 R	998	09.02 -	---			---				---	
999 S 100kW	998	03 -	---			---				---	
1000 DS	1000	03 -	DCPR8E	4339	0,9	DCPR8EVX	2265			DCPR8EIX	6546
1000 S2,HR	1000	85 -	BPR7HS	6422	0,6	BPR7HVX	2938	215		BPR7HIX	5944
1000 SuperSport	1000	03 -	DCPR8E	4339	0,9	DCPR8EVX	2265			DCPR8EIX	6546
Monster 1000 i.e.	1000	03 -	DCPR8E	4339	0,9	DCPR8EVX	2265			DCPR8EIX	6546
Multistrada 1000	1000	02 -	DPR8EA-9	4929	0,9	DPR8EVX-9	2872	221		DPR8EIX-9	2202
Multistrada 1000 S DS	1000	05 -	DPR8EA-9	4929	0,9	DPR8EVX-9	2872	221		DPR8EIX-9	2202
ST 3	1000	04 -			0,6	CR9EVX	5943			CR9EIX	3521
DUCSON											
Automatic 49	50		B6HS	4510	0,5	B6HVX	7435	203		BR6HIX	3419
S21TT,S30TT,XL50 Mercury	50		B6HS	4510	0,5	B6HVX	7435	203		BR6HIX	3419
S9,S15,S16,S20TT	50		B6HS	4510	0,5	B6HVX	7435	203		BR6HIX	3419
ENFIELD											
Bonny	50		B6HS	4510	0,5	B6HVX	7435	203		BR6HIX	3419
Sunny	50		B6HS	4510	0,5	B6HVX	7435	203		BR6HIX	3419
KB 100	100		B8ES	2411	0,5	B8EVX	7051	201		BR8EIX	5044
Bullet Strada 12,7 mm	350		BR6HS	3922	0,6		209			BR6HIX	3419
Bullet Strada 19,0 mm	350		BR6ES	4922	0,6						
De Luxe,Super Star 12,7 mm	350		BR6HS	3922	0,6		209			BR6HIX	3419
De Luxe,Super Star 19,0 mm	350		BR6ES	4922	0,6						
India	350		B7HS	5110	0,5	B7HVX	7836	204		BR7HIX	7067
India	500		B8ES	2411	0,5	B8EVX	7051	201		BR8EIX	5044
ERING											
AT 50 pt 2	50		B6HS	4510	0,6	B6HVX	7435	203		BR6HIX	3419
RT 50	50		B6HS	4510	0,6	B6HVX	7435	203		BR6HIX	3419
Tornado 50 ATV	50		BP7HS	5111	0,5	BP7HVX	7468			BPR7HIX	5944
E-TON											
Viper Juior (ATV)	40	03 -	BPM7A	7321	0,6		305				
Viper (ATV)	50	02 -	BPR7HS	6422	0,8	BPR7HVX	2938	215		BPR7HIX	5944
Sierra Ranger (ATV)	90	03 -	BPR7HS	6422	0,8	BPR7HVX	2938	215		BPR7HIX	5944
Viper (ATV)	90	02 -	BPR7HS	6422	0,8	BPR7HVX	2938	215		BPR7HIX	5944
Yukon (ATV)	150	99 -	C7HSA	4629	0,7	C7HVX	4533			CR7HIX	7544
FANTIC											
Issimo Convert/Kick	50		B5HS	4210	0,5						
Junior,Tender To	50		B5HS	4210	0,5						
Trial 50	50		B7HS	5110	0,5	B7HVX	7836	204		BR7HIX	7067
Caballero 80	75		B9HS	5810	0,5	B9HVX	2254				
Trial 75	75		B8HS	5510	0,5	B8HVX	2634	205		BR8HIX	7001
Caballero	80		B8EG	3430	0,5	B8EGV	5627				
Enduro	80		B8EG	3430	0,5	B8EGV	5627				
RSX 80	80		B8EG	3430	0,5	B8EGV	5627				
Caballero	125		B9EG	3530	0,5	B9EGV	5827			BR9EIX	3981
Cross	125		B9EG	3530	0,5	B9EGV	5827			BR9EIX	3981
Professional	125		B6HS	4510	0,5	B6HVX	7435	203		BR6HIX	3419
RSX 125	125		B9EG	3530	0,5	B9EGV	5827			BR9EIX	3981

				Order No.		Platin 	Order No.	Quick-No. 	Iridium 	Order No.
FANTIC										
Trial 125	125		B6HS	4510	0,5	B6HVX	7435	203	BR6HIX	3419
Trial / Competicion	125		B7HS	5110	0,5	B7HVX	7836	204	BR7HIX	7067
Trial 200	160		BP7HS	5111	0,5	BP7HVX	7468		BPR7HIX	5944
TX 160	160		B8EG	3430	0,5	B8EGV	5627			
Enduro	175		B8EG	3430	0,5	B8EGV	5627			
Trial 200	200		B6HS	4510	0,5	B6HVX	7435	203	BR6HIX	3419
Trial 240	240		B6HS	4510	0,5	B6HVX	7435	203	BR6HIX	3419
Section	250	95 - 97	BCP7ES	5030	0,5	BCP7EV	3733			
Trial 301 Competicion	250		BP5ES	6511	0,5	BP5EVX	5470		BPR5EIX	6597
Trial 301/305/307	250		B8ES	2411	0,5	B8EVX	7051	201	BR8EIX	5044
Trial Coach	250		B8ES	2411	0,5	B8EVX	7051	201	BR8EIX	5044
Trial K-Roo	250		B8ES	2411	0,5	B8EVX	7051	201	BR8EIX	5044
TX 250	250		B8EG	3430	0,5	B8EGV	5627			
TX 260	260		B8EG	3430	0,5	B8EGV	5627			
Professional	300		B8EG	3430	0,5	B8EGV	5627			
TX 330	330		B8EG	3430	0,5	B8EGV	5627			
FITE (LEM)										
Champion H-Y, Sandy 4M	50		B8HS	5510	0,6	B8HVX	2634	205	BR8HIX	7001
Cross CR-2, Safari BX	50		B8HS	5510	0,6	B8HVX	2634	205	BR8HIX	7001
Cross CR-3,Small,Safari BX	50		B6HS	4510	0,6	B6HVX	7435	203	BR6HIX	3419
FOX										
50 (ATV)	50	00 -	BPR7HS	6422	0,8	BPR7HVX	2938	215	BPR7HIX	5944
50 VR Sport (ATV)	50	01 -	BPR7HS	6422	0,8	BPR7HVX	2938	215	BPR7HIX	5944
90 MT (ATV)	90	99 -	CR7HSA	4549	0,8				CR7HIX	7544
100 (ATV)	100	00 -	BPR7HS	6422	0,8	BPR7HVX	2938	215	BPR7HIX	5944
G.A.C. MobyLe.										
87//89/188/188E/188TC	50	- 87	B6HS	4510	0,5	B6HVX	7435	203	BR6HIX	3419
AV49R/51/69/70/70E/72/83R	50		B6HS	4510	0,5	B6HVX	7435	203	BR6HIX	3419
AV87,AV90,D55,	50	88 -	B7HS	5110	0,5	B7HVX	7836	204	BR7HIX	7067
Cady/E14,Campera	50	- 87	B6HS	4510	0,5	B6HVX	7435	203	BR6HIX	3419
Canpera,Coma First	50	88 -	B7HS	5110	0,5	B7HVX	7836	204	BR7HIX	7067
D55/E/77//Cross,SP50	50	- 87	B6HS	4510	0,5	B6HVX	7435	203	BR6HIX	3419
D55NTT,SP95R,Cady	50	88 -	B7HS	5110	0,5	B7HVX	7836	204	BR7HIX	7067
Hawar,Chopper,Cross NTT,	50		B7HS	5110	0,5	B7HVX	7836	204	BR7HIX	7067
Kanowey,Onix,	50	88 -	B7HS	5110	0,5	B7HVX	7836	204	BR7HIX	7067
Liberty,Moby Cross,	50		B6HS	4510	0,5	B6HVX	7435	203	BR6HIX	3419
MTR Top Racing,Winner	50		B8ES	2411	0,5	B8EVX	7051	201	BR8EIX	5044
Onix 2/City/Coma,Rural	50		B7HS	5110	0,5	B7HVX	7836	204	BR7HIX	7067
Onix ,Stylo GT,	50	- 87	B6HS	4510	0,5	B6HVX	7435	203	BR6HIX	3419
SP90/90R/94/95R /96	50	- 87	B6HS	4510	0,5	B6HVX	7435	203	BR6HIX	3419
Transport ,University	50	- 87	B6HS	4510	0,5	B6HVX	7435	203	BR6HIX	3419
Transporter ,Zarpa NTT	50	88 -	B7HS	5110	0,5	B7HVX	7836	204	BR7HIX	7067
G+G										
QUAD (ATV) not Twinspark	1130	03 -	BKR7EKC	7354						
Cruso	1200	03 -	BKR7EKC	7354						
Cruso S	1200	03 -	BKR7EKC	7354						

					Order No.		Platin 	Order No.	Quick-No.	Iridium 	Order No.
GARELLI											
Bonanza	25		B6HS	4510	0,6	B6HVX	7435	203		BR6HIX	3419
Bimatic,ES,Gary Uno	50		B6HS	4510	0,5	B6HVX	7435	203		BR6HIX	3419
Formuno,Noi Matic,TL,2V	50		B6HS	4510	0,5	B6HVX	7435	203		BR6HIX	3419
Noi Bimatic,TL,ES,Team Mat	50		B6HS	4510	0,5	B6HVX	7435	203		BR6HIX	3419
Sahel 80	75		B9ES	2611	0,5	B9EVX	7254	202		BR9EIX	3981
GTA 125/ES	125		B10ES	7928	0,5	B10EGV	5927			BR10EIX	6801
Tiger 125 XLE	125		B10ES	7928	0,5	B10EGV	5927			BR10EIX	6801
323 Trail	320		BP5ES	6511	0,5	BP5EVX	5470			BPR5EIX	6597
GAS GAS											
Contact, Enducross	50		B8HS	5510	0,6	B8HVX	2634	205		BR8HIX	7001
ec boy 50	50	00 -	B8HS	5510	0,5	B8HVX	2634	205		BR8HIX	7001
Endurocross BOY	50		BPR5ES	7422	0,6	BPR5EVX	4875			BPR5EIX	6597
TXT BOY	50		BPR5ES	7422	0,6	BPR5EVX	4875			BPR5EIX	6597
Contact T 12	125	94 -	BP5ES	6511	0,5	BP5EVX	5470			BPR5EIX	6597
Cross TT 125	125				0,5	B10EGV	5927				
ec 125	125	97 -	B9EG	3530	0,6	B9EGV	5827			BR9EIX	3981
Enducross TT 125	125				0,5	B10EGV	5927				
125 Enduro	125	02 -	BR8EG	3130	0,6						
Pampera 125	125		BPR6ES	7822	0,8	BPR6EVX	6764			BPR6EIX	6637
Trial 125	125		BP5ES	6511	0,5	BP5EVX	5470			BPR5EIX	6597
TT 125	125		BR8EG	3130	0,6						
TXT 125	125	99 -	BPR5ES	7422	0,6	BPR5EVX	4875			BPR5EIX	6597
Contact T 16	143	94 -	BP5ES	6511	0,5	BP5EVX	5470			BPR5EIX	6597
ec 200	200	99 -	B10EGV	5927	0,6	B10EVX	7335				
200 Enduro	200	02 -	BR8EG	3130	0,6						
Pampera 200	200		BPR6ES	7822	0,8	BPR6EVX	6764			BPR6EIX	6637
TT 200	200		BR8EG	3130	0,6						
TXT 200	200	99 -	BPR5ES	7422	0,6	BPR5EVX	4875			BPR5EIX	6597
Contact JT 25	238	94 -	BP5ES	6511	0,5	BP5EVX	5470			BPR5EIX	6597
TXT 249	249	99 -	BPR5ES	7422	0,6	BPR5EVX	4875			BPR5EIX	6597
250 MC	250	04 -	BR8EG	3130	0,6						
Cross 250	250		BR8EG	3130	0,6						
Delta 25 GT	250		BP5ES	6511	0,5	BP5EVX	5470			BPR5EIX	6597
ec 250	250	97 -	B8EG	3430	0,5	B8EGV	5627				
Enducross 250	250				0,5	B10EGV	5927				
250 Enduro	250	02 -	BR8EG	3130	0,6						
Pampera 250	250		BPR6ES	7822	0,8	BPR6EVX	6764			BPR6EIX	6637
Piri-A 6 Magnum	250		BP5ES	6511	0,5	BP5EVX	5470			BPR5EIX	6597
Trial 250 (water + air)	250		BP5ES	6511	0,5	BP5EVX	5470			BPR5EIX	6597
TT 250	250		BR8EG	3130	0,6						
TXT 250	250		BPR5ES	7422	0,6	BPR5EVX	4875			BPR5EIX	6597
TXT 280	272	00 -	BP5ES	6511	0,5	BP5EVX	5470			BPR5EIX	6597
TXT 280	280		BPR5ES	7422	0,6	BPR5EVX	4875			BPR5EIX	6597
300 Wild (ATV)	300	02 -	BR8EG	3130	0,5						
ec 300	300	99 -	B10EGV	5927	0,6	B10EVX	7335				
300 Enduro	300	02 -	BR8EG	3130	0,6						
TT 300	300		BR8EG	3130	0,6						
Pampera 320	320		BPR6ES	7822	0,8	BPR6EVX	6764			BPR6EIX	6637
TXT 321	321	99 -	BPR5ES	7422	0,6	BPR5EVX	4875			BPR5EIX	6597
Delta 32 GT	330		BP5ES	6511	0,5	BP5EVX	5470			BPR5EIX	6597
Trial 327	330		BP5ES	6511	0,5	BP5EVX	5470			BPR5EIX	6597



Order No.



Gold-Palladium

Platin



Order No.

Quick-No.

Iridium











Order No.

GAS GAY

Trial Halley PXC 325	330		B9ES	2611	0,5	B9EVX	7254	202	BR9EIX	3981
FSE 400	400	02 -	CR8E	1275	0,7	CR8EVX	6487	226	CR8EIX	4218
450 Wild (ATV)	450	02 -	CR8E	1275	0,7	CR8EVX	6487	226	CR8EIX	4218
Normada 500	500		D8EA	2120	0,5	D8EVX	2850	216	DR8EIX	6681

GILERA

50 TS	50	01.79 - 12.82	B7ES	1111	0,5	B7EVX	6934			
CB1 4V	50		B6ES	7310	0,5	B6EVX	5136			
CBA, SS, SSV	50		B6HS	4510	0,5	B6HVX	7435	203	BR6HIX	3419
DNA 50	50	01 -	BR9ES	5722	0,6	BR9EVX	1265	208	BR9EIX	3981
Eaglet	50		B9ES	2611	0,5	B9EVX	7254	202	BR9EIX	3981
EC 1	50	92 -	B5HS	4210	0,5					
ECO	50	01.79 -	B6HS	4510	0,5	B6HVX	7435	203	BR6HIX	3419
GR 2	50	01.77 - 12.82	B6ES	7310	0,5	B6EVX	5136			
GR 2 (Export)	50		B7ES	1111	0,5	B7EVX	6934			
Grande	50		B6HS	4510	0,5	B6HVX	7435	203	BR6HIX	3419
GSA	50	03.82 -	B6HS	4510	0,5	B6HVX	7435	203	BR6HIX	3419
GSM	50	01 -	BR9ES	5722	0,6	BR9EVX	1265	208	BR9EIX	3981
RS	50	01.75 - 07.80	B6ES	7310	0,5	B6EVX	5136			
Storm	50	94 -	B9ES	2611	0,5	B9EVX	7254	202	BR9EIX	3981
Super RE, RL	50		B6ES	7310	0,5	B6EVX	5136			
Touring	50	01.73 - 12.81	B7ES	1111	0,5	B7EVX	6934			
Trend 50	50		B5HS	4210	0,6					
Trial	50		B7ES	1111	0,5	B7EVX	6934			
TS	50	01.79 - 12.82	B6ES	7310	0,5	B6EVX	5136			
80 TG 2, 3	80	03.82 - 12.82	B9ES	2611	0,5	B9EVX	7254	202	BR9EIX	3981
Jubilee	90		B7ES	1111	0,5	B7EVX	6934			
Giubileo 4 T, SS	98		B8ES	2411	0,5	B8EVX	7051	201	BR8EIX	5044
125 5V Regolarità	125				0,5	B10EGV	5927			
125 Arcore, Export	125	01.72 - 06.80	B8ES	2411	0,5	B8EVX	7051	201	BR8EIX	5044
125 C1	125				0,5	B105EGV	2171			
125 C3	125				0,5	B10EGV	5927			
125 Cross Competition	125				0,5	B105EGV	2171			
125 E1	125				0,5	B105EGV	2171			
125 Endurance	125		B9ES	2611	0,5	B9EVX	7254	202	BR9EIX	3981
125 Enduro	125				0,5	B105EGV	2171			
125 ER	125	12.87 - 03.88	B9ES	2611	0,5	B9EVX	7254	202	BR9EIX	3981
125 GR1	125	01.76 - 03.81	B7ES	1111	0,5	B7EVX	6934			
125 Hawk	125	11.85 - 12.86	B9ES	2611	0,5	B9EVX	7254	202	BR9EIX	3981
125 RTT Nebraska	125	02.86 - 03.88	B9ES	2611	0,5	B9EVX	7254	202	BR9EIX	3981
125 SV Regolarità	125				0,5	B95EGV	2145			
125 TG1	125	01.76 - 12.81	B7ES	1111	0,5	B7EVX	6934			
125 TG2	125	12.81 - 12.83	B8ES	2411	0,5	B8EVX	7051	201	BR8EIX	5044
125 TG3	125	12.81 - 12.83	B8ES	2411	0,5	B8EVX	7051	201	BR8EIX	5044
Arizona	125		B9EG	3530	0,5	B9EGV	5827		BR9EIX	3981
Coguar	125		DPR8EA-9	4929	0,9	DPR8EVX-9	2872	221	DPR8EIX-9	2202
DNA 125	125	01 -	CR9EB	6955	0,6				CR9EIX	3521
E1 Competition	125				0,5	B105EGV	2171			
Fast Bike 125	125	02.87 - 12.88	B9ES	2611	0,5	B9EVX	7254	202	BR9EIX	3981
HX 125	125				0,5	B10EGV	5927			
KK 125	125	09.86 - 12.87	B9ES	2611	0,5	B9EVX	7254	202	BR9EIX	3981
KZ 125	125	03.86 - 12.89	B9ES	2611	0,5	B9EVX	7254	202	BR9EIX	3981

					Order No.		Platin 	Order No.	Quick-No. 	Iridium 	Order No.
GILERA											
R1 S	125	09.89 -	B9EG	3530	0,5	B9EGV	5827			BR9EIX	3981
RC 125 Rally	125		B9ES	2611	0,5	B9EVX	7254	202		BR9EIX	3981
RTX	125	02.86 -12.86	B9EG	3530	0,5	B9EGV	5827			BR9EIX	3981
RV 125	125	05.84 -12.86	B9EG	3530	0,5	B9EGV	5827			BR9EIX	3981
RX 125	125	01.84 -06.85	B9EG	3530	0,5	B9EGV	5827			BR9EIX	3981
Top Rally RC	125	09.90 -	B10EG	3630	0,5	B10EGV	5927				
XR 2	125	01.89 -	B9EG	3530	0,5	B9EGV	5827			BR9EIX	3981
XRI 125	125		B9EG	3530	0,5	B9EGV	5827			BR9EIX	3981
150 Arcore, Export	150	01.72 -06.80	B8ES	2411	0,5	B8EVX	7051	201		BR8EIX	5044
DNA 180	180	01 -	CR9EB	6955	0,6					CR9EIX	3521
200 T4	200	09.82 -06.84	B8ES	2411	0,5	B8EVX	7051	201		BR8EIX	5044
Arizona	200	11.85 -12.86	B9EG	3530	0,5	B9EGV	5827			BR9EIX	3981
RTX	200	02.86 -12.86	B9EG	3530	0,5	B9EGV	5827			BR9EIX	3981
RV 200 LC	200	01.85 -12.86	B9EG	3530	0,5	B9EGV	5827			BR9EIX	3981
RX 200 LC	200	01.85 -12.86	B9EG	3530	0,5	B9EGV	5827			BR9EIX	3981
250 Arizona Rally	250	11.85 -12.86	B9ES	2611	0,5	B9EVX	7254	202		BR9EIX	3981
250 C3	250					B10SEGV	2171				
250 KK, KZ	250		B9ES	2611	0,5	B9EVX	7254	202		BR9EIX	3981
250 NGR	250	05.85 -12.86	B9ES	2611	0,5	B9EVX	7254	202		BR9EIX	3981
HX 250	250					B10SEGV	2171				
NX 250 LC	250					B10SEGV	2171				
RV 250 NGR	250		B9ES	2611	0,5	B9EVX	7254	202		BR9EIX	3981
Dakota 350	350		DP9EA-9	6629	0,9	DRP9EVX-9	3331			DPR9EIX-9	5545
Dakota 350 ER	350		DP9EA-9	6629	0,9	DP9EVX-9	3331			DPR9EIX-9	5545
XRT 350	350	05.88 -	DP9EA-9	6629	0,9	DP9EVX-9	3331			DPR9EIX-9	5545
Dakota 500	500	04.87 -	DP9EA-9	6629	0,9	DP9EVX-9	3331			DPR9EIX-9	5545
Saturno 500	500	04.88 - 92	DP9EA-9	6629	0,9	DP9EVX-9	3331			DPR9EIX-9	5545
XRT 600	550	05.88 - 92	DP9EA-9	6629	0,9	DP9EVX-9	3331			DPR9EIX-9	5545
600 FB (Nordcape)	600	92 -	D8EA	2120	0,5	D8EVX	2850	216		DR8EIX	6681
RC 600	600	- 92	D8EA	2120	0,5	D8EVX	2850	216		DR8EIX	6681
RC 600 C	600	92 -	D8EA	2120	0,5	D8EVX	2850	216		DR8EIX	6681
GIMSON											
Cantigo TT,Cross,Jumper	50		B5HS	4210	0,5						
Elite Sport/Super/E2/E87,	50		B5HS	4210	0,5						
Nevada/AL,Maxi Automatico	50		B5HS	4210	0,5						
Polaris,Shipper Trial,	50		B5HS	4210	0,5						
Variomatic,LSA,LSA-RA	50		B5HS	4210	0,5						
HARLEY-DAVIDSON											
M50	50		B8ES	2411	0,5	B8EVX	7051	201		BR8EIX	5044
M50S	50		B8ES	2411	0,5	B8EVX	7051	201		BR8EIX	5044
M65	65		BP5ES	6511	0,6	BP5EVX	5470			BPR5EIX	6597
M65S	65		BP5ES	6511	0,6	BP5EVX	5470			BPR5EIX	6597
MC65	65		BP5ES	6511	0,6	BP5EVX	5470			BPR5EIX	6597
80DS	80		B7HS	5110	0,6	B7HVX	7836	204		BR7HIX	7067
X 90	90		BP5ES	6511	0,6	BP5EVX	5470			BPR5EIX	6597
XZ 90	90		BP5ES	6511	0,6	BP5EVX	5470			BPR5EIX	6597
Baja MSR	100		B8ES	2411	0,5	B8EVX	7051	201		BR8EIX	5044
SR 100	100		B8ES	2411	0,5	B8EVX	7051	201		BR8EIX	5044
M 125	125		BP5ES	6511	0,6	BP5EVX	5470			BPR5EIX	6597
ML 125	125		BP5ES	6511	0,6	BP5EVX	5470			BPR5EIX	6597



Order No.



Gold-Palladium



Platin

Order No.



Quick-No.

Iridium



Order No.

HARLEY-DAVIDSON

MLS 125	125		BP5ES	6511	0,6	BP5EVX	5470		BPR5EIX	6597
Rapido	125		BP5ES	6511	0,6	BP5EVX	5470		BPR5EIX	6597
SS 125	125		B9ES	2611	0,5	B9EVX	7254	202	BR9EIX	3981
SX 125	125		B7ES	1111	0,5	B7EVX	6934			
SXT 125	125		B9ES	2611	0,5	B9EVX	7254	202	BR9EIX	3981
SS 175	175		B9ES	2611	0,5	B9EVX	7254	202	BR9EIX	3981
SX 175	175		B9ES	2611	0,5	B9EVX	7254	202	BR9EIX	3981
MX 250	250				0,6	B10EVX	7335		BR10EIX	6801
SS 250	250		B9ES	2611	0,5	B9EVX	7254	202	BR9EIX	3981
SX 250	250		B9ES	2611	0,5	B9EVX	7254	202	BR9EIX	3981
all models / Alle Modelle	350	73 - 74	B8ES	2411	0,5	B8EVX	7051	201	BR8EIX	5044
XL V2 Evolution	883	85 -	DCPR7E	3932	1,0	DCPR7EVX	1179		DCPR7EIX	6046
KH	900	54 - 71	B6L	3212	1,0					
XL	900	54 - 71	B6L	3212	1,0					
XL	1000	79 - 85	BPR6HS-10	2633	1,0					
XL	1000	71 - 78	B6L	3212	1,0					
XR	1000	83 - 85	BPR6ES-11	4824	1,1	BPR6EVX-11	4233		BPR6EIX-11	3903
XL	1100	86 - 87	DCPR7E	3932	1,0	DCPR7EVX	1179		DCPR7EIX	6046
VRSC-V-Rod	1130	02	DCPR8E	4339	0,7	DCPR8EVX	2265		DCPR8EIX	6546
FL Panhead	1200	48 - 65	XR5	5953	0,7				XR5IX	7355
FL Shovel Head	1200	66 - 74	XR5	5953	0,7				XR5IX	7355
FL Shovel Head	1200	75 - 81	BPR5ES-11	4424	1,1	BPR5EVX-11	2738		BPR5EIX-11	2115
FX Panhead	1200	48 - 65	XR5	5953	0,7				XR5IX	7355
FX Shovel Head	1200	66 - 74	XR5	5953	0,7				XR5IX	7355
FX Shovel Head	1200	75 - 81	BPR5ES-11	4424	1,1	BPR5EVX-11	2738		BPR5EIX-11	2115
XL 1200R Sportster Evolution	1200	04	DCPR7E	3932	1,0	DCPR7EVX	1179		DCPR7EIX	6046
XL V-2 Evolution	1200	86	DCPR7E	3932	1,0	DCPR7EVX	1179		DCPR7EIX	6046
FL Shovel Head	1340	78 - 81	BPR5ES-11	4424	1,1	BPR5EVX-11	2738		BPR5EIX-11	2115
FL Shovel Head	1340	82 - 84	BPR5ES-11	4424	1,1	BPR5EVX-11	2738		BPR5EIX-11	2115
FL V-2 Evolution	1340	84	BPR5ES-11	4424	1,1	BPR5EVX-11	2738		BPR5EIX-11	2115
FL V-2 Evolution F.I.	1340	95 - 98	BPR5ES-11	4424	1,1	BPR5EVX-11	2738		BPR5EIX-11	2115
FX Shovel Head	1340	78 - 81	BPR5ES-11	4424	1,1	BPR5EVX-11	2738		BPR5EIX-11	2115
FX Shovel Head	1340	82 - 84	BPR5ES-11	4424	1,1	BPR5EVX-11	2738		BPR5EIX-11	2115
FX V-2 Evolution	1340	84	BPR5ES-11	4424	1,1	BPR5EVX-11	2738		BPR5EIX-11	2115
FL TC 88 CV Carb	1450	98	DCPR7E	3932	1,0	DCPR7EVX	1179		DCPR7EIX	6046
FL TC88 EFI	1450	98	DCPR7E	3932	1,0	DCPR7EVX	1179		DCPR7EIX	6046
FX TC88 CV Carb	1450	98	DCPR7E	3932	1,0	DCPR7EVX	1179		DCPR7EIX	6046

HERCULES

Saxonette	30	01.87 -	BP4	2911	0,5					
City Bike C1	50	10.72 -08.78	B6HS	4510	0,7	B6HVX	7435	203	BR6HIX	3419
City Bike C2	50	10.72 -08.78	B6HS	4510	0,7	B6HVX	7435	203	BR6HIX	3419
City Bike C3	50	09.74 -08.78	B6HS	4510	0,7	B6HVX	7435	203	BR6HIX	3419
Hobby Rider HR 1	50	10.72 -12.87	B6HS	4510	0,7	B6HVX	7435	203	BR6HIX	3419
Hobby Rider HR 2	50	10.72 -12.87	B6HS	4510	0,7	B6HVX	7435	203	BR6HIX	3419
Jogging	50		B6HS	4510	0,5	B6HVX	7435	203	BR6HIX	3419
K 50	50	-08.78	B8HS	5510	0,7	B8HVX	2634	205	BR8HIX	7001
K 50 Ultra	50	-08.78	B8HS	5510	0,7	B8HVX	2634	205	BR8HIX	7001
K 50 Ultra II	50	-08.78	B8HS	5510	0,5	B8HVX	2634	205	BR8HIX	7001
K 50 Ultra LC	50	-08.78	B9ES	2611	0,5	B9EVX	7254	202	BR9EIX	3981
K 50 Ultra LC II	50	-08.78	B9ES	2611	0,5	B9EVX	7254	202	BR9EIX	3981
K 50 Ultra LC III	50	-08.78	B9ES	2611	0,5	B9EVX	7254	202	BR9EIX	3981



Order No.



Gold-Palladium

Platin



Order No.

Quick-No.

Iridium



Order No.

HERCULES

K 125 X	125		B8HS	5510	0,5	B8HVX	2634	205	BR8HIX	7001
175 GS	175		B9ES	2611	0,5	B9EVX	7254	202	BR9EIX	3981
250 GS	250		B9ES	2611	0,5	B9EVX	7254	202	BR9EIX	3981
W 2000 (Wankel)	294		BR8ES	5422	0,5	BR8EVX	1262	207	BR8EIX	5044
350 GS	350				0,5	B9EVX	7254		BR9EIX	3981

HESKETH

V 1000	1000		DR8ES	5423	0,7	DR8EVX	6354	217	DR8EIX	6681
--------	------	--	-------	------	-----	--------	------	-----	--------	------

HM RACING







Baja SX	50	98 -	B8ES	2411	0,5	B8EVX	7051	201	BR8EIX	5044
CRX Junior & Senior	50	01 -	B8HS	5510	0,5	B8HVX	2634	205	BR8HIX	7001
CRX Racing Junior & Senior	50	01 -	B8HS	5510	0,5	B8HVX	2634	205	BR8HIX	7001
Derapage	50	98 -	B8ES	2411	0,5	B8EVX	7051	201	BR8EIX	5044
MX Junior & Senior	50	01 -	B8HS	5510	0,5	B8HVX	2634	205	BR8HIX	7001
Six	50	98 -	B8ES	2411	0,5	B8EVX	7051	201	BR8EIX	5044

HMZ

Cruise 125	125	96 -	D8EA	2120	0,6	D8EVX	2850	216	DR8EIX	6681
------------	-----	------	------	------	-----	-------	------	-----	--------	------

HONDA

Camino PA 50	50	01.75 - 12.87	BPR6HS	7022	0,7	BPR6HVX	2740	214	BPR6HIX	4085
CB 50	50		CR6HS	7023	0,7			223	CR6HIX	7274
CB 50 Y	50	01.73 - 01.83	CR6HS	7023	0,7			223	CR6HIX	7274
CY 50	50	01.81 -	CR6HS	7023	0,7			223	CR6HIX	7274
Elite 50/S	50		BPR6HSA	4632	0,7				BPR6HIX	4085
MB 50 F (AC01)	50		BR8HS	4322	0,8	BR8HVX	6265	212	BR8HIX	7001
MB 50 S (AC01)	50		BR7HS	4122	0,8			211	BR7HIX	7067
MBX 50 M (AC05)	50		BR9ES	5722	0,8	BR9EVX	1265	208	BR9EIX	3981
MBX 50 S (AC05)	50		BR9ES	5722	0,7	BR9EVX	1265	208	BR9EIX	3981
MBX 50 SD (AC05)	50		BR6ES	4922	0,7					
MR 50	50		BR6HS	3922	0,7			209	BR6HIX	3419
MT 50 F (AD04)	50		BR8HS	4322	0,7	BR8HVX	6265	212	BR8HIX	7001
MT 50 S (AD04)	50		BR6ES	4922	0,7					
MTX 50 R	50		BR8ES	5422	0,7	BR8EVX	1262	207	BR8EIX	5044
MTX 50 S	50	86 -	BR7HS	4122	0,7			211	BR7HIX	7067
NC 50	50		BPR4HS	7823	0,7					
NE 50	50		BPR6HSA	4632	0,7				BPR6HIX	4085
NE 50 Vision	50	90 -	BR6HSA	4296	0,7			210	BR6HIX	3419
NSR 50	50	89 -	BR5ES	4722	0,8					
NT 50	50		BPR6HSA	4632	0,7				BPR6HIX	4085
NX 50	50		BPR5HS	6222	0,7					
NX 50 M	50		BPR5HS	6222	0,7					
PA 50	50	84 -	BP6HS	4511	0,7	BP6HVX	4635		BPR6HIX	4085
PF 50	50		BR6HS	3922	0,7			209	BR6HIX	3419
PK 50 DX (AB25)	50	95 -	BR6HSA	4296	0,7			210	BR6HIX	3419
PK 50 Walloroo	50	90 -	BR6HSA	4296	0,7			210	BR6HIX	3419
PM 50	50		BR6HS	3922	0,7			209	BR6HIX	3419
PX 50	50	84 -	BPR5HS	6222	0,7					
PX 50 E	50	80 -	BPR5HS	6222	0,7					
PX 50 R	50	85 -	BPR5HS	6222	0,7					
PZ 50	50		BR6HS	3922	0,7			209	BR6HIX	3419

					Order No.		Platin 	Order No.	Quick-No. 	Iridium 	Order No.
HONDA											
SA 50 (AF29)	50		BR6HSA	4296	0,7				210	BR6HIX	3419
SE 50	50		BPR6HSA	4632	0,7					BPR6HIX	4085
SFX 50	50	96 -	BR6HSA	4296	0,6				210	BR6HIX	3419
SH 50 T (AF40)	50	97 -	BR6HSA	4296	0,7				210	BR6HIX	3419
SH 50	50	01.84 -	BR8HS	4322	0,7	BR8HVX	6265		212	BR8HIX	7001
SJ 50 Bali	50		BR6HSA	4296	0,6				210	BR6HIX	3419
ST 50 C (AB23) Dax	50		CR6HSA	2983	0,7					CR6HIX	7274
TLM 50	50		BR8ES	5422	0,8	BR8EVX	1262	207	BR8EIX	5044	
XL 50	50	01.80 -	CR6HS	7023	0,7				223	CR6HIX	7274
XR 50	50	93 - 02	CR6HSA	2983	0,7					CR6HIX	7274
XR 50 R	50	03 -	CR6HSA	2983	0,7					CR6HIX	7274
Z 50 GZ	50	01.80 - 12.84	CR6HS	7023	0,7				223	CR6HIX	7274
Z 50 J	50	-	CR6HS	7023	0,7				223	CR6HIX	7274
Z 50 R	50	94 -	CR6HSA	2983	0,7					CR6HIX	7274
ZB 50 P (AB22)	50	88 -	CR6HSA	2983	0,7					CR6HIX	7274
Zoomer	50	05 -	ER8EH-N								
CT 70	70	92 -	CR6HSA	2983	0,7					CR6HIX	7274
ST 70	70	94 -	CR6HSA	2983	0,7					CR6HIX	7274
TRX 70 (ATV)	70		CR7HS	7223	0,7					CR7HIX	7544
NS-1	75	96 -	BR8ECS	3972	0,7						
CR 80 R	80	- 85	BR9ES	5722	0,8	BR9EVX	1265	208	BR9EIX	3981	
CR 80 R	80	86 -	BR10EG	3830	0,6						
CY 80	80	-	CR7HS	7223	0,7					CR7HIX	7544
MB 80 (HC01)	80	01.80 -	BR8HS	4322	0,7	BR8HVX	6265	212	BR8HIX	7001	
MBX 80 SWD/SW2D (HC04)	80	87 -	BR9ES	5722	0,8	BR9EVX	1265	208	BR9EIX	3981	
MCX 80 (HC05)	80	01.80 -	BR9ES	5722	0,8	BR9EVX	1265	208	BR9EIX	3981	
MT 80 F	80		BR9HS	4522	0,7						
MT 80 S (HD02)	80		BR8HS	4322	0,7	BR8HVX	6265	212	BR8HIX	7001	
MTX 80 C	80	82 -	BR9HS	4522	0,7						
MTX 80 R (D) (HD08)	80		BR9ES	5722	0,7	BR9EVX	1265	208	BR9EIX	3981	
MTX 80 R (F) (HD08)	80		BR8ES	5422	0,7	BR8EVX	1262	207	BR8EIX	5044	
MTX 80 R II (HD09)	80	87 -	BR9ES	5722	0,8	BR9EVX	1265	208	BR9EIX	3981	
MTX 80 RS (HD08)	80	83 - 85	BR9ES	5722	0,8	BR9EVX	1265	208	BR9EIX	3981	
NSR 80	80		BR8ES	5422	0,8	BR8EVX	1262	207	BR8EIX	5044	
SH 80 E Scoopy	80	84 -	BPR6HS	7022	0,7	BPR6HVX	2740	214	BPR6HIX	4085	
XR 80R	80	92 -	CR7HSA	4549	0,7					CR7HIX	7544
CR 85 R	85	03 -	BR10EG	3830	0,6						
CR 85 R 2	85	03 -	BR10EG	3830	0,6						
EZ 90	90	93 -	BR7HS	4122	0,7				211	BR7HIX	7067
NH 90 M	90	93 -	BPR6HSA	4632	0,7					BPR6HIX	4085
NH 90 Yupy	90	90 -	BPR6HSA	4632	0,7					BPR6HIX	4085
TRX 90 (ATV)	90	93 - 94	CR6HSA	2983	0,7					CR6HIX	7274
TRX 90 (ATV)	90	95 -	CR7HSA	4549	0,7					CR7HIX	7544
XR 100R	100	92 -	CR7HSA	4549	0,7					CR7HIX	7544
CG 110	110		DR8ESL	2923	0,7	DR8EVX	6354	218	DR8EIX	6681	
ATC 125 M (ATV)	125		DR8ESL	2923	0,6	DR8EVX	6354	218	DR8EIX	6681	
CA 125 Rebel (JC24)	125	95 -	CR6HSA	2983	0,7					CR6HIX	7274
CA 125 C Rebel (JC26)	125	97 -	CR6HSA	2983	0,7					CR6HIX	7274
CB 125	125		DR8ES	5423	0,7	DR8EVX	6354	217	DR8EIX	6681	
CB 125 K	125		D8HA	7012	0,7						
CB 125 T	125		CR8HS	7423	0,7	CR8HVX	7236			CR8HIX	7669
CB 125 Y	125		CR8HS	7423	0,7	CR8HVX	7236			CR8HIX	7669



Order No.



Gold-Palladium



Platin

Order No.



Quick-No.







Iridium



Order No.

HONDA

CBR 125 R	125	04 -	CR9E	6263	0,7	CR9EVX	5943	227	CR9EIX	3521
CG 125 (JC27)	125	98 -	DPR8EA-9	4929	0,9	DPR8EVX-9	2872	221	DPR8EIX-9	2202
CG 125	125		DR8ESL	2923	0,6	DR8EVX	6354	218	DR8EIX	6681
CH 125	125		DPR7EA-9	5129	0,9	DPR7EVX-9	7682	220	DPR7EIX-9	7803
CLR 125 Cityfly (JD18A/B)	125	98 -	DPR8EA-9	4929	0,9	DPR8EVX-9	2872	221	DPR8EIX-9	2202
CM 125 (JC05)	125		CR7HS	7223	0,7				CR7HIX	7544
CM 125 C Custom	125	94 -	CR7HSA	4549	0,7				CR7HIX	7544
CR 125 R	125		BR9EG	3230	0,6	BR9EVX	1265		BR9EIX	3981
CR 125 R	125	03 -	BR9EG	3230	0,6	BR9EVX	1265		BR9EIX	3981
Italia 125 (I)	125		DR8ESL	2923	0,6	DR8EVX	6354	218	DR8EIX	6681
Lead 125 (JF01)	125		BPR6HS	7022	0,7	BPR6HVX	2740	214	BPR6HIX	4085
MBX 125 F	125		BR9ES	5722	0,7	BR9EVX	1265	208	BR9EIX	3981
MTX 125	125		BR9ES	5722	0,7	BR9EVX	1265	208	BR9EIX	3981
MTX 125 R (I)	125		BR8ES	5422	0,7	BR8EVX	1262	207	BR8EIX	5044
MTX 125 R2 (I)	125		BR9ES	5722	0,7	BR9EVX	1265	208	BR9EIX	3981
NS 125 F (I)	125		BR9ES	5722	0,6	BR9EVX	1265	208	BR9EIX	3981
NS 125 R (I)	125		BR9ES	5722	0,6	BR9EVX	1265	208	BR9EIX	3981
NSR 125 F	125		BR9ECS	3570	0,8					
NSR 125 R (JC22)	125		BR9ECS	3570	0,8					
NX 125	125		DR8ESL	2923	0,7	DR8EVX	6354	218	DR8EIX	6681
TL 125	125		DR8ESL	2923	0,6	DR8EVX	6354	218	DR8EIX	6681
TRAX 125 (ATV)	125		DR8ESL	2923	0,7	DR8EVX	6354	218	DR8EIX	6681
TRX 125 (ATV)	125		DR8ESL	2923	0,7	DR8EVX	6354	218	DR8EIX	6681
Varadero 125	125	01 -	CR8EH-9	5666	0,9	CR8EHVX-9	4546	228	CR8EHIX-9	3797
VT 125 C Shadow (G-Type)	125		CR8EH-9	5666	0,9	CR8EHVX-9	4546	228	CR8EHIX-9	3797
XL 125 (I)	125		DR8ESL	2923	0,6	DR8EVX	6354	218	DR8EIX	6681
XL 125 R	125		DR8ESL	2923	0,7	DR8EVX	6354	218	DR8EIX	6681
XL 125 S	125		DR8ESL	2923	0,7	DR8EVX	6354	218	DR8EIX	6681
XLR 125 R	125	98 -	DPR8EA-9	4929	0,9	DPR8EVX-9	2872	221	DPR8EIX-9	2202
XR 125	125		DR8ESL	2923	0,7	DR8EVX	6354	218	DR8EIX	6681
XR 125 L	125	03 -	DPR9EA-9	5329	0,9	DPR9EVX-9	3854	222	DPR9EIX-9	5545
XR 125 L (ED)	125	03 -	DPR8EA-9	4929	0,9	DPR8EVX-9	2872	221	DPR8EIX-9	2202
ATC 185 (ATV)	185		D8EA	2120	0,7	D8EVX	2850	216	DR8EIX	6681
ATC 185 S (ATV)	185		DR8ESL	2923	0,6	DR8EVX	6354	218	DR8EIX	6681
CD 185 T	185		CR7HS	7223	0,7				CR7HIX	7544
CM 185 T	185	01.78 -	CR7HS	7223	0,7				CR7HIX	7544
XL 185 S	185	01.79 -	DR8ESL	2923	0,6	DR8EVX	6354	218	DR8EIX	6681
ATC 200 (ATV)	200		DR8ESL	2923	0,6	DR8EVX	6354	218	DR8EIX	6681
CD 200 T	200		CR7HS	7223	0,7				CR7HIX	7544
CM 200 T	200		CR7HS	7223	0,7				CR7HIX	7544
MTX 200 RW (MD07)	200	83 - 85	BR9ES	5722	0,7	BR9EVX	1265	208	BR9EIX	3981
TR 200	200		DR8ESL	2923	0,6	DR8EVX	6354	218	DR8EIX	6681
TRX 200 D (ATV)	200	92 -	DR8ESL	2923	0,6	DR8EVX	6354	218	DR8EIX	6681
TRX 200 SX (ATV)	200		DR8ESL	2923	0,7	DR8EVX	6354	218	DR8EIX	6681
XL 200 R	200	01.83 -	DR8EA	7162	0,7	DR8EVX	6354		DR8EIX	6681
XR 200	200	84 - 86	DPR9Z	4830	0,7					
XR 200	200	87 -	DR8ESL	2923	0,7	DR8EVX	6354	218	DR8EIX	6681
XR 200	200	- 83	DR8ESL	2923	0,6	DR8EVX	6354	218	DR8EIX	6681
XR 200 R	200	84 - 84	DPR9Z	4830	0,7					
XR 200 R	200	- 83	DR8ESL	2923	0,7	DR8EVX	6354	218	DR8EIX	6681
XR 200 R	200	94 -	DR8ESL	2923	0,6	DR8EVX	6354	218	DR8EIX	6681
250 Spacy (I)	250		DPR6EA-9	5531	0,9					

					Order No.		Platin 	Order No.	Quick-No.	Iridium 	Order No.
HONDA											
ATC 250 ES /SX (ATV)	250	85 -	DR8ESL	2923	0,7	DR8EVX	6354	218	DR8EIX	6681	
ATC 250 R (ATV)	250		BR9ES	5722	0,8	BR9EVX	1265	208	BR9EIX	3981	
CB 250 (MC26)	250	96 -	CR6HSA	2983	0,7				CR6HIX	7274	
CB 250 N	250	01.80 -	DR8ES	5423	0,7	DR8EVX	6354	217	DR8EIX	6681	
CB 250 Nighthawk	250	92 -	CR6HSA	2983	0,7				CR6HIX	7274	
CB 250 RS (MC02)	250	01.80 -	DR8ES	5423	0,7	DR8EVX	6354	217	DR8EIX	6681	
CB 250 T	250		DR8ESL	2923	0,7	DR8EVX	6354	218	DR8EIX	6681	
CBF 250	250	04 -	CR8EH-9S		0,9						
CBX 250	250		DPR8EA-9	4929	0,9	DPR8EVX-9	2872	221	DPR8EIX-9	2202	
CD 250 U	250		CR6HSA	2983	0,7				CR6HIX	7274	
CH 250	250		DPR6EA-9	5531	0,9						
CM 250 C (MC06)	250	01.82 -	CR7HS	7223	0,7				CR7HIX	7544	
CM 250 T	250		DR8ES	5423	0,7	DR8EVX	6354	217	DR8EIX	6681	
CMX 250 CT (MC13)	250	96 -	CR6HSA	2983	0,7				CR6HIX	7274	
CMX 250 C (MC32B)	250	97 -	CR6HSA	2983	0,7				CR6HIX	7274	
CR 250	250	87 -	BR9EG	3230	0,6	BR9EVX	1265		BR9EIX	3981	
CR 250 R	250	- 81			0,6	BR9EVX	1265		BR9EIX	3981	
CR 250 R	250	82 - 02	BR8EG	3130	0,6						
CR 250 R	250	03 -	BR8EG	3130	0,6						
CRF 250 R	250	04 -			0,9	IMR9C-9H	6777				
EX 250	250		CR7HS	7223	0,7				CR7HIX	7544	
FL 250 (ATV)	250		BR9ES	5722	0,8	BR9EVX	1265	208	BR9EIX	3981	
NSR 250	250	93 - 96	BR9ECM	3252	0,6	BR9ECMVX	2434				
NX 250 J (MD21)	250	88 -	CR9EH-9	7502	0,9	CR9EHVX-9	3872	229	CR9EHIX-9	6216	
NX 250 K (MD21)	250	89 -	CR9EH-9	7502	0,9	CR9EHVX-9	3872	229	CR9EHIX-9	6216	
NX 250 L (MD25)	250	91 -	CR9EH-9	7502	0,9	CR9EHVX-9	3872	229	CR9EHIX-9	6216	
TLR 250	250		DPR6EA-9	5531	0,9						
TRAX 250 (ATV)	250		DR8ESL	2923	0,6	DR8EVX	6354	218	DR8EIX	6681	
TRX 250 (ATV)	250		DR8ESL	2923	0,6	DR8EVX	6354	218	DR8EIX	6681	
TRX 250 EX (ATV)	250	05 -	DPR8EA-9	4929	0,9	DPR8EVX-9	2872	221	DPR8EIX-9	2202	
TRX 250 R (ATV)	250		BR9ES	5722	0,6	BR9EVX	1265	208	BR9EIX	3981	
TRX 250 X (ATV)	250		DR8ESL	2923	0,7	DR8EVX	6354	218	DR8EIX	6681	
VT 250 F2	250		DPR8EA-9	4929	0,9	DPR8EVX-9	2872	221	DPR8EIX-9	2202	
XL 250 R (MD11)	250	86 -	DPR9Z	4830	0,7						
XL 250 R (MD11)	250	84 - 85	DPR9Z	4830	0,8						
XL 250 R (MD11)	250	- 83	DR8ESL	2923	0,7	DR8EVX	6354	218	DR8EIX	6681	
XL 250 S (MD11)	250	01.73 - 12.83	DR8ESL	2923	0,6	DR8EVX	6354	218	DR8EIX	6681	
XR 250 L	250	92 -	DPR8Z	4730	0,7						
XR 250 R	250	- 83	DR8ESL	2923	0,6	DR8EVX	6354	218	DR8EIX	6681	
XR 250 R / RN	250	84 -	DPR9Z	4830	0,7						
TRX 300 (ATV)	300	93 -	DPR8EA-9	4929	0,9	DPR8EVX-9	2872	221	DPR8EIX-9	2202	
TRX 300 EX (ATV)	300	93 -	DR8ESL	2923	0,6	DR8EVX	6354	218	DR8EIX	6681	
TRX 300 FW (ATV)	300	93 -	DPR8EA-9	4929	0,9	DPR8EVX-9	2872	221	DPR8EIX-9	2202	
TRX 300 N (ATV)	300	92 -	DPR8EA-9	4929	0,9	DPR8EVX-9	2872	221	DPR8EIX-9	2202	
TRX 300 EX (ATV)	300	05 -	DR8ES-L	2923	0,7	DR8EVX	6354		DR8EIX	6681	
ATC 350 X (ATV)	350		DR8ESL	2923	0,7	DR8EVX	6354	218	DR8EIX	6681	
FL 350 R (ATV)	350		BR9ES	5722	0,8	BR9EVX	1265	208	BR9EIX	3981	
TRX 350 FE (ATV)	350	05 -	DPR7EA-9	5129	0,9	DPR7EVX-9	7682	220	DPR7EIX-9	7803	
TRX 350 (ATV)	350	93 -	DR8ESL	2923	0,6	DR8EVX	6354	218	DR8EIX	6681	
TRX 350 FM (ATV)	350	05 -	DPR7EA-9	5129	0,9	DPR7EVX-9	7682	220	DPR7EIX-9	7803	
TRX 350 TE (ATV)	350	05 -	DPR7EA-9	5129	0,9	DPR7EVX-9	7682	220	DPR7EIX-9	7803	
TRX 350 TM (ATV)	350	05 -	DPR7EA-9	5129	0,9	DPR7EVX-9	7682	220	DPR7EIX-9	7803	



Order No.



Gold-Palladium

Platin



Order No.

Quick-No.







Iridium



Order No.

HONDA

XL 350 R (ND03)	350	85 - 87	DPR8EA-9	4929	0,9	DPR8EVX-9	2872	221	DPR8EIX-9	2202
XR 350 R	350		DPR8EA-9	4929	0,9	DPR8EVX-9	2872	221	DPR8EIX-9	2202
400 Hawk (I)	400		DR8ES	5423	0,7	DR8EVX	6354	217	DR8EIX	6681
CB 400 A	400	0179 -	DR8ES	5423	0,7	DR8EVX	6354	217	DR8EIX	6681
CB 400 N	400	01.78 -12.84	DR8ES	5423	0,7	DR8EVX	6354	217	DR8EIX	6681
CB 400 T	400		DR8ES	5423	0,7	DR8EVX	6354	217	DR8EIX	6681
CB-1 (NC27)	400	91 -	CR8EH-9	5666	0,9	CR8EHVX-9	4546	228	CR8EHIX-9	3797
CBX 400 F	400		DPR9Z	4830	0,7					
CBX 400 F2	400		DPR9Z	4830	0,7					
CBX 400 SS (I)	400		DPR9Z	4830	0,7					
CM 400 T	400	01.80 -12.84	DR8ES	5423	0,7	DR8EVX	6354	217	DR8EIX	6681
CX 400 C	400		DR8ESL	2923	0,7	DR8EVX	6354	218	DR8EIX	6681
CX 400 F2	400		DR8ESL	2923	0,7	DR8EVX	6354	218	DR8EIX	6681
NS 400	400		BR9ES	5722	0,8	BR9EVX	1265	208	BR9EIX	3981
NS 400 R (NC19)	400	85 -	BR9ES	5722	0,8	BR9EVX	1265	208	BR9EIX	3981
TRX 400 FA (ATV)	400	05 -	DPR8EA-9	4929	0,9	DPR8EVX-9	2872	221	DPR8EIX-9	2202
TRX 400 FGA (ATV)	400	05 -	DPR8EA-9	4929	0,9	DPR8EVX-9	2872	221	DPR8EIX-9	2202
TRX 400 FW (ATV)	400	95 -	DPR7EA-9	5129	0,9	DPR7EVX-9	7682	220	DPR7EIX-9	7803
VF 400 F	400	01.85 -	DPR8EA-9	4929	0,9	DPR8EVX-9	2872	221	DPR8EIX-9	2202
VFR 400 R (NC24)	400	87 -	C8EH-9	7473	0,7	C8EHVX-9	4450		CR8EHIX-9	3797
VFR 400 R (NC30)	400	91 -	ER9EH	5869	0,7					
XL 400	400	01.84 -	DR8EA	7162	0,7	DR8EVX	6354		DR8EIX	6681
XR 400 R	400	96 -	DPR8Z	4730	0,7					
CB 450 N (PC14)	450	85 -	DR8ES	5423	0,7	DR8EVX	6354	217	DR8EIX	6681
CB 450 S (PC17)(D)	450	86 - 88	DR8ESL	2923	0,7	DR8EVX	6354	218	DR8EIX	6681
CB 450 S (PC17)(I)	450		DR8ES	5423	0,7	DR8EVX	6354	217	DR8EIX	6681
CMX 450 C	450		DPR8EA-9	4929	0,9	DPR8EVX-9	2872	221	DPR8EIX-9	2202
CRF 450 R 4T	450	02 -			1,1				IFR8H-11	5068
CRS R2 / R3	450	02 -			1,1				IFR9H-11	6588
TRX 450 (ATV)	450	05 -	DPR7EA-9	5129	0,9	DPR7EVX-9	7682	220	DPR7EIX-9	7803
CR 480 R	480		BR8EG	3130	0,5					
CB 500 (PC26)	500	94 -	CR9EH-9	7502	0,9	CR9EHVX-9	3872	229	CR9EHIX-9	6216
CB 500 (K1)	500	- 75			0,6	D7EVX	2734			
CB 500 (K3)	500	- 75	DR7ES	3123	0,6					
CB 500 (PC32)	500	96 -	CR8EH-9	5666	0,9	CR8EHVX-9	4546	228	CR8EHIX-9	3797
CB 500 R	500		BR8EG	3130	0,5					
CB 500 / S (PC32)	500	98 -	CR8EH-9	5666	0,9	CR8EHVX-9	4546	228	CR8EHIX-9	3797
CBF 500	500	04 -	CR8EH-9S		0,9					
CBR 500 F	500		DPR8EA-9	4929	0,9	DPR8EVX-9	2872	221	DPR8EIX-9	2202
CR 500	500		BR8EG	3130	0,5					
CX 500	500		DR8ESL	2923	0,7	DR8EVX	6354	218	DR8EIX	6681
CX 500 C (PC01)	500	01.79 -12.84	DR8ESL	2923	0,7	DR8EVX	6354	218	DR8EIX	6681
CX 500 E (PC06)	500	01.79 -12.84	DR8ESL	2923	0,6	DR8EVX	6354	218	DR8EIX	6681
CX 500 Turbo (PC03)	500	01.83 -			0,9	DPR8EVX-9	2872		DPR8EIX-9	2202
FT 500 (PC07)	500	01.82 -12.85	DR8EA	7162	0,7	DR8EVX	6354		DR8EIX	6681
GB 500 (PC16)	500	92 -	DPR8EA-9	4929	0,9	DPR8EVX-9	2872	221	DPR8EIX-9	2202
GL 500 (PC02)	500	01.79 -12.84	DR8ESL	2923	0,6	DR8EVX	6354	218	DR8EIX	6681
NX 500	500		DPR8EA-9	4929	0,9	DPR8EVX-9	2872	221	DPR8EIX-9	2202
TRX 500 (ATV)	500	05 -			0,9				IJR7A-9	
TRX 500 FA (ATV)	500	02 -							IJR7A-9	
VF 500 F (PC12)	500	84 -	DPR8EA-9	4929	0,9	DPR8EVX-9	2872	221	DPR8EIX-9	2202
VF 500 F2 (PC12)	500	85 -	DPR9EA-9	5329	0,9	DPR9EVX-9	3854	222	DPR9EIX-9	5545

					Order No.		Platin 	Order No.	Quick-No.	Iridium 	Order No.
HONDA											
VF 500 F2 (PC12)	500	- 84	DPR8EA-9	4929	0,9	DPR8EVX-9	2872	221	DPR8EIX-9	2202	
VT 500 C (PC08)	500	83 -	DPR8EA-9	4929	0,9	DPR8EVX-9	2872	221	DPR8EIX-9	2202	
VT 500 E (PC11)	500	83 - 85	DPR8EA-9	4929	0,9	DPR8EVX-9	2872	221	DPR8EIX-9	2202	
XBR 500 (PC15)	500	85 - 87	DPR8EA-9	4929	0,9	DPR8EVX-9	2872	221	DPR8EIX-9	2202	
XBR 500 S (PC15)	500	88 -	DPR8EA-9	4929	0,9	DPR8EVX-9	2872	221	DPR8EIX-9	2202	
XL 500 (I)	500		DR8ESL	2923	0,7	DR8EVX	6354	218	DR8EIX	6681	
XL 500 R (PD02)	500	- 85	DR8ESL	2923	0,7	DR8EVX	6354	218	DR8EIX	6681	
XL 500 R (PD02)	500	86 -	DR8ES	5423	0,7	DR8EVX	6354	217	DR8EIX	6681	
XL 500 S (PD01)	500	01.79 -12.81	DR8ESL	2923	0,7	DR8EVX	6354	218	DR8EIX	6681	
XR 500	500		DR8ESL	2923	0,7	DR8EVX	6354	218	DR8EIX	6681	
XR 500 R	500		DPR8EA-9	4929	0,9	DPR8EVX-9	2872	221	DPR8EIX-9	2202	
CB 550	550	0671 - 1287	DR7ES	3123	0,7						
CB 550 (F1/F2)	550	76 -			0,6	D7EVX	2734				
CB 550 (K3/4)	550	76 -	DR7ES	3123	0,6						
CB 550 F	550	06.71 - 12.7	DR7ES	3123	0,7						
CBX 550 F (PC04)	550		DR8ES	5423	0,7	DR8EVX	6354	217	DR8EIX	6681	
CBX 550 F2 (PC04)	550		DR8ES	5423	0,7	DR8EVX	6354	217	DR8EIX	6681	
600 V Transalp (PD06)	600	87 -	DPR8EA-9	4929	0,9	DPR8EVX-9	2872	221	DPR8EIX-9	2202	
CB 600 F W (PC34A/B/D) Hornet	600	98 -	CR9EH-9	7502	0,9	CR9EHVX-9	3872	229	CR9EIX-9	6216	
CB 600 F W (PC34A/B/D)	600	98 -	CR9EH-9	7502	0,9	CR9EHVX-9	3872	229	CR9EIX-9	6216	
CBF 600 (ED)	600	04 -	CR9EH-9	7502	0,9	CR9EHVX-9	3872	227	CR9EIX-9	6216	
CBR 600 F (PC23)	600	89 - 90	DPR9EA-9	5329	0,9	DPR9EVX-9	3854	222	DPR9EIX-9	5545	
CBR 600 F (PC25)	600	91 - 94	CR9EH-9	7502	0,9	CR9EHVX-9	3872	229	CR9EIX-9	6216	
CBR 600 F (PC19)	600	87 - 88	DPR8EA-9	4929	0,9	DPR8EVX-9	2872	221	DPR8EIX-9	2202	
CBR 600 F / FS (PC35)	600	01 - 03			0,9				IMR9C-9H	6777	
CBR 600 F X (PC35)	600	99 - 00	CR9EH-9	7502	0,9	CR9EHVX-9	3872	229	CR9EIX-9	6216	
CBR 600 F2	600	93 - 94	CR9EH-9	7502	0,9	CR9EHVX-9	3872	229	CR9EIX-9	6216	
CBR 600 F3 (PC31)(PC35)	600	95 - 00	CR9EH-9	7502	0,9	CR9EHVX-9	3872	229	CR9EIX-9	6216	
CBR 600 RR	600	05 -			0,9				IMR9C-9HES	5766	
CBR 600 RR (G)	600	03 -			0,9				IMR9C-9H	6777	
CBX 600 E	600	01.83 -12.87	DPR8EA-9	4929	0,9	DPR8EVX-9	2872	221	DPR8EIX-9	2202	
NTV 600	600		DPR8EA-9	4929	0,9	DPR8EVX-9	2872	221	DPR8EIX-9	2202	
NX 600	600		DPR8EA-9	4929	0,9	DPR8EVX-9	2872	221	DPR8EIX-9	2202	
VT 600 / D	600	93 - 00	DPR8EA-9	4929	0,9	DPR8EVX-9	2872	221	DPR8EIX-9	2202	
VT 600 C (PC21)	600	88 - 93	DPR8EA-9	4929	0,9	DPR8EVX-9	2872	221	DPR8EIX-9	2202	
VT 600 C Shadow (I)	600	01.88 - 93	DPR8EA-9	4929	0,9	DPR8EVX-9	2872	221	DPR8EIX-9	2202	
XL 600 L	600		DPR8EA-9	4929	0,9	DPR8EVX-9	2872	221	DPR8EIX-9	2202	
XL 600 LM (PD04)	600	85 - 87	DPR8EA-9	4929	0,9	DPR8EVX-9	2872	221	DPR8EIX-9	2202	
XL 600 R (PD03)	600	83 - 87	DPR8EA-9	4929	0,9	DPR8EVX-9	2872	221	DPR8EIX-9	2202	
XL 600 RM (I)	600		DPR8EA-9	4929	0,9	DPR8EVX-9	2872	221	DPR8EIX-9	2202	
XL 600 RM (PD04)	600	86 -	DPR8EA-9	4929	0,9	DPR8EVX-9	2872	221	DPR8EIX-9	2202	
XL 600 V / VN	600	87 -	DPR8EA-9	4929	0,9	DPR8EVX-9	2872	221	DPR8EIX-9	2202	
XR 600 / V	600		DPR8EA-9	4929	0,9	DPR8EVX-9	2872	221	DPR8EIX-9	2202	
XR 600 R / L	600	01.87 -	DPR8EA-9	4929	0,9	DPR8EVX-9	2872	221	DPR8EIX-9	2202	
FX 650 (RD09) Vigor	650	99 -	DPR8EA-9	4929	0,9	DPR8EVX-9	2872	221	DPR8EIX-9	2202	
CB 650 (RC03)	650	01.80 -	DR8ESL	2923	0,7	DR8EVX	6354	218	DR8EIX	6681	
CB 650 C (RC05)	650		DR8ESL	2923	0,7	DR8EVX	6354	218	DR8EIX	6681	
CB 650 SC (RC08)	650	01.80 -	DPR8EA-9	4929	0,9	DPR8EVX-9	2872	221	DPR8EIX-9	2202	
CB 650 Z	650		DR8ESL	2923	0,7	DR8EVX	6354	218	DR8EIX	6681	
CBX 650 E (RC13)	650	83 -	DPR9EA-9	5329	0,9	DPR9EVX-9	3854	222	DPR9EIX-9	5545	
CBX 650 Night Hawk(I)	650		DPR9EA-9	5329	0,9	DPR9EVX-9	3854	222	DPR9EIX-9	5545	
CX 650 C (RC11)	650	01.83 -	DPR8EA-9	4929	0,9	DPR8EVX-9	2872	221	DPR8EIX-9	2202	



Order No.



Gold-Palladium



Platin

Order No.



Quick-No.







Iridium















Order No.

HONDA

CX 650 E (RC13)	650	01.83 -	DPR8EA-9	4929	0,9	DPR8EVX-9	2872	221	DPR8EIX-9	2202
CX 650 Turbo (RC16)	650	01.82 -			0,9	DPR8EVX-9	2872		DPR8EIX-9	2202
FMX 650	650	05 -	DPR8EA-9	4929	0,9	DPR8EVX-9	2872	221	DPR8EIX-9	2202
GL 650 (RC10)	650	01.83 -	DPR8EA-9	4929	0,9	DPR8EVX-9	2872	221	DPR8EIX-9	2202
NT 650 V (RC47) Deauville	650	98 -	DPR8EA-9	4929	0,9	DPR8EVX-9	2872	221	DPR8EIX-9	2202
NTV 650 (RC33)	650	88 -	DPR8EA-9	4929	0,9	DPR8EVX-9	2872	221	DPR8EIX-9	2202
NTV 650 Revere (I)	650	01.88 -	DPR8EA-9	4929	0,9	DPR8EVX-9	2872	221	DPR8EIX-9	2202
NX 650 (RD02)/Dominator	650	88 -	DPR8EA-9	4929	0,9	DPR8EVX-9	2872	221	DPR8EIX-9	2202
NX 650 Dominator (RD08)(I)	650	01.88 -	DPR8EA-9	4929	0,9	DPR8EVX-9	2872	221	DPR8EIX-9	2202
SLR 650 (RD09)	650	97 -	DPR8EA-9	4929	0,9	DPR8EVX-9	2872	221	DPR8EIX-9	2202
Rincon TRX 650 (ATV)	650	01.04 -			1,1				IFR5L-11	
TRX 650 FA (ATV)	650	05 -			1,1				IFR5L-11	
TRX 650 FGA (ATV)	650	05 -			1,1				IFR5L-11	
XL 650L	650	94 -	DPR8EA-9	4929	0,9	DPR8EVX-9	2872	221	DPR8EIX-9	2202
Transalp XL 650	650	94 -	DPR8EA-9	4929	0,9	DPR8EVX-9	2872	221	DPR8EIX-9	2202
XR 650 R (R1)	650	00 -	BKR8E-11	6587	1,1					
XRV 650 (RD03)	650	88 -	DPR8EA-9	4929	0,9	DPR8EVX-9	2872	221	DPR8EIX-9	2202
VT 700 C	700		DPR7EA-9	5129	0,9	DPR7EVX-9	7682	220	DPR7EIX-9	7803
CB 750 (RC42)	750	92 -	DPR8EA-9	4929	0,9	DPR8EVX-9	2872	221	DPR8EIX-9	2202
CB 750 (RC04)	750	01.82 - 12.83	DR8EA	7162	0,7	DR8EVX	6354		DR8EIX	6681
CB 750 C (RC06)	750	01.80 -	DR8ES	5423	0,7	DR8EVX	6354	217	DR8EIX	6681
CB 750 F	750	- 91	DR8ES	5423	0,7	DR8EVX	6354	217	DR8EIX	6681
CB 750 F2	750	-	DR8ES	5423	0,7	DR8EVX	6354	217	DR8EIX	6681
CB 750 F2N / FII	750	91 -	DPR8EA-9	4929	0,9	DPR8EVX-9	2872	221	DPR8EIX-9	2202
CB 750 FA (I)	750		DR8ES	5423	0,7	DR8EVX	6354	217	DR8EIX	6681
CB 750 Four (I)	750		DR8ESL	2923	0,7	DR8EVX	6354	218	DR8EIX	6681
CB 750 FZ	750		DR8ESL	2923	0,7	DR8EVX	6354	218	DR8EIX	6681
CB 750 K	750	01.82 - 12.83	DR8ES	5423	0,7	DR8EVX	6354	217	DR8EIX	6681
CB 750 KZ	750		DR8ESL	2923	0,9	DR8EVX	6354	218	DR8EIX	6681
CB Seven Fifty	750		DPR8EA-9	4929	0,9	DPR8EVX-9	2872	221	DPR8EIX-9	2202
CBX 750 F (RC17)	750	84 - 86	DPR8EA-9	4929	0,9	DPR8EVX-9	2872	221	DPR8EIX-9	2202
CBX 750 F2	750		DPR9EA-9	5329	0,9	DPR9EVX-9	3854	222	DPR9EIX-9	5545
NR 750 (RC40)	750	93 -	CR9EH-9	7502	0,9	CR9EHVX-9	3872	229	CR9EHIX-9	6216
RVF (RC45)	750	94 -			0,9	CR9EHVX-9	3872		CR9EHIX-9	6216
Shadow 750	750	04 -	DPR8EA-9	4929	0,9	DPR8EVX-9	2872	221	DPR8EIX-9	2202
VF 750 C	750	95 - 00	CR8EH-9	5666	0,9	CR8EHVX-9	4546	228	CR8EHIX-9	3797
VF 750 C Magna	750	94 - 95	CR8EH-9	5666	0,9	CR8EHVX-9	4546	228	CR8EHIX-9	3797
VF 750 C (RC09)	750	86 - 94	DPR9EA-9	5329	0,9	DPR9EVX-9	3854	222	DPR9EIX-9	5545
VF 750 C (RC09)	750	82 - 84	DPR8EA-9	4929	0,9	DPR8EVX-9	2872	221	DPR8EIX-9	2202
VF 750 C (RC44)	750	97 - 00	DPR9EA-9	5329	0,9	DPR9EVX-9	3854	222	DPR9EIX-9	5545
VF 750 F (RC15)	750	83 - 84	DPR8EA-9	4929	0,9	DPR8EVX-9	2872	221	DPR8EIX-9	2202
VF 750 S (RC07)	750	82 - 83	DPR8EA-9	4929	0,9	DPR8EVX-9	2872	221	DPR8EIX-9	2202
VFR 750 F	750	94 -	CR8EH-9	5666	0,9	CR8EHVX-9	4546	228	CR8EHIX-9	3797
VFR 750 F (I)	750		DPR9EA-9	5329	0,9	DPR9EVX-9	3854	222	DPR9EIX-9	5545
VFR 750 F (RC24)	750	86 - 87	DPR8EA-9	4929	0,9	DPR8EVX-9	2872	221	DPR8EIX-9	2202
VFR 750 F (RC24)	750	88 - 89	DPR9EA-9	5329	0,9	DPR9EVX-9	3854	222	DPR9EIX-9	5545
VFR 750 F (RC36)	750	90 - 94	CR8EH-9	5666	0,9	CR8EHVX-9	4546	228	CR8EHIX-9	3797
VFR 750 FJ (I)	750		DPR9EA-9	5329	0,9	DPR9EVX-9	3854	222	DPR9EIX-9	5545
VFR 750 R (RC30)	750	88 -	CR9EH-9	7502	0,9	CR9EHVX-9	3872	229	CR9EHIX-9	6216
VT 750 Black Widow (RC48)	750	00 -	DPR8EA-9	4929	0,9	DPR8EVX-9	2872	221	DPR8EIX-9	2202
VT 750 C (RC29)	750	87 -	DPR8EA-9	4929	0,9	DPR8EVX-9	2872	221	DPR8EIX-9	2202
VT 750 C/C2V (RC44)	750	97 -	DPR8EA-9	4929	0,9	DPR8EVX-9	2872	221	DPR8EIX-9	2202

					Order No.		Platin 	Order No.	Quick-No.		Order No.
HONDA											
XLV 750 R (RD01)	750	83 -	DPR8EA-9	4929	0,9	DPR8EVX-9	2872	221	DPR8EIX-9		2202
XRV 750 (RD04)	750	90 - 92	DPR8EA-9	4929	0,9	DPR8EVX-9	2872	221	DPR8EIX-9		2202
XRV 750 (RD07)	750	93 -	DPR8EA-9	4929	0,9	DPR8EVX-9	2872	221	DPR8EIX-9		2202
PC 800 Pacific Coast	800	98 -	DPR7EA-9	5129	0,9	DPR7EVX-9	7682	220	DPR7EIX-9		7803
VFR / VFR ABS	800	02 -			0,9				IMR9B-9H		4888
VFR 800 FI W (RC46)	800	98 -	CR9EH-9	7502	0,9	CR9EHVX-9	3872	229	CR9EHIX-9		6216
CB 900 F	900	01.79 - 12	DR8ES	5423	0,7	DR8EVX	6354	217	DR8EIX		6681
CB 900 F2	900	01.79 - 12.83	DR8ES	5423	0,7	DR8EVX	6354	217	DR8EIX		6681
CBR 900 RR (SC33)	900	96 -	CR9EH-9	7502	0,9	CR9EHVX-9	3872	229	CR9EHIX-9		6216
CBR 900 RR (SC28)	900	91 -	CR9EH-9	7502	0,9	CR9EHVX-9	3872	229	CR9EHIX-9		6216
CBR 900 RRY (Fireblade)(SC44)	900	00 -			0,9				CR9EIH-9		6419
Hornet 900	900	02 -	CR8EH-9	5666	0,9	CR8EHVX-9	4546	228	CR8EHIX-9		3797
CBR 900 RR Fireblade 2002 (SC50)	950	02 -			0,9				IMR9C-9H		6777
CB 1000 F (SC30)	1000	93 - 00	DPR9EA-9	5329	0,9	DPR9EVX-9	3854	222	DPR9EIX-9		5545
CBR 1000 RR Fireblade	1000	04 -			0,9				IMR9C-9HES		5766
CBR 1000 F (SC24)	1000	95 - 00	DPR9EA-9	5329	0,9	DPR9EVX-9	3854	222	DPR9EIX-9		5545
CBR 1000 F (SC21)	1000	87 - 88	DPR9EA-9	5329	0,9	DPR9EVX-9	3854	222	DPR9EIX-9		5545
CBR 1000 F (SC24)	1000	89 - 92	DPR9EA-9	5329	0,9	DPR9EVX-9	3854	222	DPR9EIX-9		5545
CBR 1000 Fireblade (G)	1000	04 -			0,9				IMR9C-9HES		5766
CBR 1000 K (I)	1000		DPR9EA-9	5329	0,9	DPR9EVX-9	3854	222	DPR9EIX-9		5545
GL 1000 (GL1)	1000		DR8ESL	2923	0,7	DR8EVX	6354	218	DR8EIX		6681
Varadero 1000 (SD02)	1000	03 -			0,9				IJR8B-9		4873
Varadero XL 1000 V X (SD01)	1000	99 -			0,9	DPR8EVX-9	2872		DPR8EIX-9		2202
Varadero XL 1000 V (G)(SD02) 69KW	1000	03 -			0,9				IJR8B-9		4873
VF 1000 Bol D'Dor(I)	1000		DPR9EA-9	5329	0,9	DPR9EVX-9	3854	222	DPR9EIX-9		5545
VF 1000 F	1000	- 86	DPR9EA-9	5329	0,9	DPR9EVX-9	3854	222	DPR9EIX-9		5545
VF 1000 F (SC15)	1000	87 -	DPR8EA-9	4929	0,9	DPR8EVX-9	2872	221	DPR8EIX-9		2202
VF 1000 F2 (SC15)	1000	85 -	DPR9EA-9	5329	0,9	DPR9EVX-9	3854	222	DPR9EIX-9		5545
VF 1000 R (SC16)	1000	84 - 86	DPR8EA-9	4929	0,9	DPR8EVX-9	2872	221	DPR8EIX-9		2202
VTR 1000 F (SC36)	1000	97 -			0,9	DPR9EVX-9	3854		DPR9EIX-9		5545
VTR1000 SP-1	1000	00 - 01			1,1				FR9BI-11		4709
VTR1000 SP-2	1000	02 -			1,1				IFR9H-11		6588
CBX 1000 (CB1)	1050		DR8ESL	2923	0,7	DR8EVX	6354	218	DR8EIX		6681
CB 1100 F (SC11)	1100		DR8ES	5423	0,7	DR8EVX	6354	217	DR8EIX		6681
CB 1100 R (SC08)	1100		DR8ES	5423	0,7	DR8EVX	6354	217	DR8EIX		6681
CBR 1100 XX Super Blackbird	1100	01 -			0,9				IMR9C-9H		6777
CBR 1100 XX (SC35)	1100	97 - 00			0,9	CR9EHVX-9	3872		CR9EHIX-9		6216
GL 1100 (SC02)	1100	82 -	DPR8EA-9	4929	0,9	DPR8EVX-9	2872	221	DPR8EIX-9		2202
GL 1100 (SC02)	1100	- 81	DR8ESL	2923	0,7	DR8EVX	6354	218	DR8EIX		6681
GL 1100 DX (SC02)	1100	82 -	DPR8EA-9	4929	0,9	DPR8EVX-9	2872	221	DPR8EIX-9		2202
GL 1100 DX (SC02)	1100	- 81	DR8ESL	2923	0,7	DR8EVX	6354	218	DR8EIX		6681
GL 1100 R	1100	-	DR8ES	5423	0,7	DR8EVX	6354	217	DR8EIX		6681
ST 1100 CBS	1100	96 -	CR8EH-9	5666	0,8	CR8EHVX-9	4546	228	CR8EHIX-9		3797
ST 1100 (SC26)	1100	90 -	CR8EH-9	5666	0,9	CR8EHVX-9	4546	228	CR8EHIX-9		3797
ST 1100 AN (SC26)	1100	92 -	CR8EH-9	5666	0,9	CR8EHVX-9	4546	228	CR8EHIX-9		3797
VF 1100 C (SC12)	1100	83 -	DPR8EA-9	4929	0,9	DPR8EVX-9	2872	221	DPR8EIX-9		2202
VT 1100 C3 W Shadow Aero(SC39A/E/C)	1100	98 - 00	DPR7EA-9	5129	0,9	DPR7EVX-9	7682	220	DPR7EIX-9		7803
VT 1100 C	1100	95 - 00	DPR7EA-9	5129	0,9	DPR7EVX-9	7682	220	DPR7EIX-9		7803
VT 1100 C (SC23)	1100	88 - 95	DPR7EA-9	5129	0,9	DPR7EVX-9	7682	220	DPR7EIX-9		7803
VT 1100 C (SC23)	1100	94 - 95	DPR8EA-9	4929	0,9	DPR8EVX-9	2872	221	DPR8EIX-9		2202
VT 1100 C2 (SC32)	1100	95 -	DPR7EA-9	5129	0,9	DPR7EVX-9	7682	220	DPR7EIX-9		7803
X-Eleven	1100	00 -			0,9	CR8EHVX-9	4546		CR8EHIX-9		3797

				Order No.		Platin 	Order No.	Quick-No.	Iridium 	Order No.
HONDA										
GL 1200 (SC14)	1200	84 - 87	DPR8EA-9	4929	0,9	DPR8EVX-9	2872	221	DPR8EIX-9	2202
CB 1300	1300	03 -	DPR9EA-9	5329	0,9	DPR9EVX-9	3854	222	DPR9EIX-9	5545
Pan European (SC51)	1300	02 -	CR8EH-9	5666	0,9	CR8EHVX-9	4546	228	CR8EHIX-9	3797
VTX 1300	1300	03 -	DCPR6E	3481	0,8					
VTX 1300S	1300	03 -	DCPR6E	3481	0,8					
X 4	1300	97 -	DPR9EA-9	5329	0,9	DPR9EVX-9	3854	222	DPR9EIX-9	5545
F 6 C	1500	11.96 -	DPR7EA-9	5129	0,9	DPR7EVX-9	7682	220	DPR7EIX-9	7803
GL 1500 (SC22)	1500	91 - 93	DCPR7EA-9	5129	0,9	DPR7EVX-9	7682	220	DPR7EIX-9	7803
GL 1500 C (SC34)	1500	97 -	DPR7EA-9	5129	0,9	DPR7EVX-9	7682	220	DPR7EIX-9	7803
GL 1500 C F6C (SC34)	1500	97 -	DPR7EA-9	5129	0,9	DPR7EVX-9	7682	220	DPR7EIX-9	7803
GL 1500 SE.A	1500	95 -	DPR7EA-9	5129	0,9	DPR7EVX-9	7682	220	DPR7EIX-9	7803
GL 1500A/SE	1500	94 - 94	DPR6EA-9	5531	0,9					
VTX 1500 (Twinspark)	1500	03 -			1,1				IFR6L11	3687
GL 1800 Gold Wing	1800	01 -	BKR6E-11	2756	1,1	BKR6EVX-11	3540		BKR6EIX-11	3764
Gold Wing (GL1800)	1800	01 -	BKR6E-11	2756	1,1	BKR6EVX-11	3540		BKR6EIX-11	3764
VTX 1800	1800	01 -			1,1				IFR6L-11	3678
HOREX										
Regina 400	400	53 - 56	B8HS	5510	0,6	B8HVX	2634	205	BR8HIX	7001
HRD										
Slide Sonic Supermotorrad	50	98 -	BR8ES	5422	0,6	BR8EVX	1262	207	BR8EIX	5044
GS Enduro	50	98 - 99	BR8ES	5422	0,6	BR8EVX	1262	207	BR8EIX	5044
Sonic 2 Trail	50	99 -	BR8ES	5422	0,6	BR8EVX	1262	207	BR8EIX	5044
Sonic 2 SM	50	99 -	BR8ES	5422	0,6	BR8EVX	1262	207	BR8EIX	5044
Super Mot. Cabr.	125	99 -	CR9EB	6955	0,7				CR9EIX	3521
Trail Cabr.	125	99 -	CR9EB	6955	0,7				CR9EIX	3521
HUSABERG										
FE 350	350	91 - 99	C8E	7471	0,7	CR8EVX	6487		CR8EIX	4218
MC 350	350	- 99	C8E	7471	0,7	CR8EVX	6487		CR8EIX	4218
400	400	03 -			0,6	DCPR8EVX	2265			
FC 400	400	97 - 99	C8E	7471	0,7	CR8EVX	6487		CR8EIX	4218
FE 400	400	97 - 99	C8E	7471	0,7	CR8EVX	6487		CR8EIX	4218
FE 400 e	400	00 - 02	DCPR8E	4179	0,6	DCPR8EVX	2265		DCPR8EIX	6546
FS 400 c	400	00 - 02	DCPR8E	4179	0,6	DCPR8EVX	2265		DCPR8EIX	6546
FS 400 e	400	00 - 02	DCPR8E	4179	0,6	DCPR8EVX	2265		DCPR8EIX	6546
450	450	03 -			0,6	DCPR8EVX	2265			
FC 470/6	470	00 - 02	DCPR8E	4179	0,6	DCPR8EVX	2265		DCPR8EIX	6546
FX 470 e	470	00 - 02	DCPR8E	4179	0,6	DCPR8EVX	2265		DCPR8EIX	6546
FC 499MX	499	95 - 99	C8E	7471	0,7	CR8EVX	6487		CR8EIX	4218
FE 500	500	91 - 94	C8E	7471	0,7	CR8EVX	6487		CR8EIX	4218
FE 500	500	91 - 99	C8E	7471	0,7	CR8EVX	6487		CR8EIX	4218
FE 501 e	500	00 -	DCPR8E	4179	0,6	DCPR8EVX	2265		DCPR8EIX	6546
MC 501	500	- 99	C8E	7471	0,7	CR8EVX	6487		CR8EIX	4218
501	501	03 -			0,6	DCPR8EVX	2265			
FC 501	501	95 - 99	C8E	7471	0,7	CR8EVX	6487		CR8EIX	4218
FE 501 E	501	93 - 99	C8E	7471	0,7	CR8EVX	6487		CR8EIX	4218
FE 501	501	93 - 99	C8E	7471	0,7	CR8EVX	6487		CR8EIX	4218
FX 501	501	97 - 99	C8E	7471	0,7	CR8EVX	6487		CR8EIX	4218
FX 501	501	97 - 99	C8E	7471	0,7	CR8EVX	6487		CR8EIX	4218
550	550	03 -			0,6	DCPR8EVX	2265			

					Order No.		Platin 	Order No.	Quick-No.	Iridium 	Order No.
HUSABERG											
FC 550/4	550	00 -	DCPR8E	4179	0,6	DCPR8EVX	2265				6546
FC 550/6	550	00 -	DCPR8E	4179	0,6	DCPR8EVX	2265			DCPR8EIX	6546
FC 600	600	92 - 99	C8E	7471	0,7	CR8EVX	6487			CR8EIX	4218
FE 600	600	92 - 99	C8E	7471	0,7	CR8EVX	6487			CR8EIX	4218
FES 600 E	600	98 - 99	C8E	7471	0,7	CR8EVX	6487			CR8EIX	4218
FX 600	600	97 - 99	C8E	7471	0,7	CR8EVX	6487			CR8EIX	4218
FX 600	600	97 - 99	C8E	7471	0,7	CR8EVX	6487			CR8EIX	4218
FX 600 E	600	97 - 99	C8E	7471	0,7	CR8EVX	6487			CR8EIX	4218
MC 600	600	- 99	C8E	7471	0,7	CR8EVX	6487			CR8EIX	4218
650	650	03 -			0,6	DCPR8EVX	2265				
FE 650 e	650	00 -	DCPR8E	4179	0,6	DCPR8EVX	2265			DCPR8EIX	6546
FS 650 c	650	00 -	DCPR8E	4179	0,6	DCPR8EVX	2265			DCPR8EIX	6546
FS 650 e	650	00 -	DCPR8E	4179	0,6	DCPR8EVX	2265			DCPR8EIX	6546
FX 650 e	650	00 -	DCPR8E	4179	0,6	DCPR8EVX	2265			DCPR8EIX	6546
HUSQVARNA											
Husky boy basic	50	01 -	B8HS	5510	0,5	B8HVX	2634	205		BR8HIX	7001
Husky boy junior	50	01 -	B6HS	4510	0,5	B6HVX	7435	203		BR6HIX	3419
Husky boy senior	50	01 -	B6HS	4510	0,5	B6HVX	7435	203		BR6HIX	3419
Husky boy racing	50	01 -	B6HS	4510	0,5	B6HVX	7435	203		BR6HIX	3419
SM 50	50	02 -	BR9ES	5722	0,6	BR9EVX	1265	208		BR9EIX	3981
WRE 50	50	02 -	BR9ES	5722	0,6	BR9EVX	1265	208		BR9EIX	3981
125 CR	125	92 - 94			0,5	B10EGV	5927				
125 CR	125	90 - 91			0,6	B10EGV	5927				
125 CR	125	97 -			0,5	B10EGV	5927				
125 CR	125	99 - 00			0,5	BR9EG	3230				
CR 125	125	01 -			0,5	BR9EG	3230				
125 NWR	125	99 -			0,5	B95EGV	2145				
125 SM	125	99 -	BR9EG	3230	0,5						
125 WER	125	99 -	BR9EG	3230	0,5						
125 WR	125	90 - 92			0,5	B95EGV	2145				
125 WR	125	93 - 94			0,5	B9EGV	5827				
125 WR	125	95 - 00			0,5	B10EGV	5927				
125 WRE	125	98 - 01	B9EG	3530	0,7	B9EGV	5827			BR9EIX	3981
SM 125	125	02 -			0,5	BR9EG	3230				
WER 125	125	02 -	B9EG	3530	0,7	B9EGV	5827			BR9EIX	3981
WR 125	125	01 -			0,5	BR9EG	3230				
250 CR	250	95 - 00			0,5	B9EGV	5827				
250 CR	250	92 - 92			0,5	B9EGV	5827				
250 CR	250	90 -			0,5	B9EGV	5827				
250 CR	250	93 - 94			0,6	B10EGV	5927				
250 CR	250	01 -	BR8EG	3130	0,8						
250 WR (5A00)	250	96 - 99			0,6	B9EGV	5827				
250 WR	250	92 - 95			0,5	B9EGV	5827				
250 WR	250	99 -	B8EG	3430	0,5	B8EGV	5627				
260 WR	250	90 -			0,5	B9EGV	5827				
CR 250	250	01 -	BR8EG	3130	0,6						
TC 250	250	01 -	CR8EB	7784	0,6	CR8EVX	6487			CR8EIX	4218
TE 250 / R	250	01 -	CR8EB	7784	0,6	CR8EVX	6487			CR8EIX	4218
WR 250	250	01 -	B8EG	3430	0,5	B8EGV	5627				
350 TE	350	90 -	C7E	5096	0,7					CR7EIX	7385
350 TE	350	95 -	C7E	5096	0,7					CR7EIX	7385



Order No.



Gold-Palladium

Platin



Order No.

Quick-No.

Iridium









Order No.







HUSQVARNA







360 CR	360	91 -			0,5	B8EGV	5627				
360 WR	360	91 - 97			0,5	B8EGV	5627				
360 WR	360	98 - 00	B8EG	3430	0,5	B8EGV	5627				
360 WXC	360	98 -	B8EG	3430	0,5	B8EGV	5627				
WR 360	360	01 -	B8EG	3430	0,5	B8EGV	5627				
390 MX	390		B9ES	2611	0,5	B9EVX	7254	202	BR9EIX	3981	
400 MX	400		B9ES	2611	0,5	B9EVX	7254	202	BR9EIX	3981	
410 TE (2AA)	400	96 - 00	C7E	5096	0,6				CR7EIX	7385	
SM / R 400 R	400	01 -	CR8EB	7784	0,6	CR8EVX	6487		CR8EIX	4218	
TE 400 R	400	01 -	CR8EB	7784	0,6	CR8EVX	6487		CR8EIX	4218	
TE 410	400	01 -	C7E	5096	0,6				CR7EIX	7385	
410 TE	410	95 - 96	C7E	5096	0,7				CR7EIX	7385	
430 CR	430		B9ES	2611	0,5	B9EVX	7254	202	BR9EIX	3981	
450 SMR	450	04 -	CR8EB	7784	0,6	CR8EVX	6487		CR8EIX	4218	
SM 450 R	450	03 -	CR8EB	7784	0,6	CR8EVX	6487		CR8EIX	4218	
SMR 450	450	03 -	CR7EB	4663	0,6						
TC 450	450	01 -	CR8EB	7784	0,6	CR8EVX	6487		CR8EIX	4218	
TE 450	450	03 -	CR8EB	7784	0,6	CR8EVX	6487		CR8EIX	4218	
TE 510	450	03 -	CR8EB	7784	0,6	CR8EVX	6487		CR8EIX	4218	
510 TE/AC	510		DP8EA-9	5829	0,9	DPR8EVX-9	2872		DPR8EIX-9	2202	
510 TE/TC	510	87 - 90	C7E	5096	0,7				CR7EIX	7385	
SM 570 R	570	01 -	C7E	5096	0,7				CR7EIX	7385	
SMR 570	570	03 -	CR7EB	4663	0,6						
SMR 570 NOX	570	02 -	R0045J-10	7400							
SM / R 570	576	07.01 -	CR7EB	4663	0,6						
TC 570	576	07.01 -	CR7EB	4663	0,7						
TE 570	576	07.01 -	CR7EB	4663	0,7						
610 e TE/TC	610	98 -	C7E	5096	0,7				CR7EIX	7385	
610 TE/TC	610	91 -	C7E	5096	0,7				CR7EIX	7385	
SM 610 e	610	98 -	C7E	5096	0,7				CR7EIX	7385	
SM 610 S	610	03 -	C7E	5096	0,7				CR7EIX	7385	
SMR 630	630	04 -	R0045J-10	7400							

HYOSUNG

50 (ATV)	50	03 -	BP6HS	4511	0,7	BP6HVX	4635		BPR6HIX	4085	
90 (ATV)	50	03 -	BPR7HS	6422	0,8	BPR7HVX	2938	215	BPR7HIX	5944	
WOW 50 (ATV)	50	04 -	BP7HS	5111	0,7	BP7HVX	7468		BPR7HIX	5944	
WOW 90 (ATV)	90	04 -	BP7HS	5111	0,7	BP7HVX	7468		BPR7HIX	5944	
Aquila (GV125)	125	00 -	CR8E	1275	0,6	CR8EVX	6487	226	CR8EIX	4218	
Cruise 125 I (GA125)	125	96 - 96	D8EA	2120	0,6	D8EVX	2850	216	DR8EIX	6681	
Cruise 125 I (GA125)	125	97 -	DR8EA	7162	0,6	DR8EVX	6354		DR8EIX	6681	
Cruise 125 II (GA125F)	125	97 -	CR8EH-9	5666	0,7	CR8EHVX-9	4546	228	CR8EHIX-9	3797	
Cruise 125 II Classic (GA125F-CLS)	125	99 -	CR8EH-9	5666	0,7	CR8EHVX-9	4546	228	CR8EHIX-9	3797	
GF 125 (GF125)	125	98 -	CR8EH-9	5666	0,8	CR8EHVX-9	4546	228	CR8EHIX-9	3797	
GS 125 (GS125)	125	97 -	DR8EA	7162	0,6	DR8EVX	6354		DR8EIX	6681	
Hyper 125 (GPS125)	125	98 -	DR8EA	7162	0,6	DR8EVX	6354		DR8EIX	6681	
Karion 125	125	02 -	CR8EH-9	5666	0,8	CR8EHVX-9	4546	228	CR8EHIX-9	3797	
Naked 125	125	01 -	CR8E	1275	0,6	CR8EVX	6487	226	CR8EIX	4218	
XRX 125 (RX125)	125	99 -	CR8EH-9	5666	0,8	CR8EHVX-9	4546	228	CR8EHIX-9	3797	
Aquila (GV250) 8V	250	00 -	CR8E	1275	0,6	CR8EVX	6487	226	CR8EIX	4218	
GT 250	250	05 -	CR8E	1275	0,7	CR8EVX	6487	226	CR8EIX	4218	
650 Naked	650	04 -	CR8E	1275	0,6	CR8EVX	6487	226	CR8EIX	4218	

				Order No.		Gold-Palladium	Platin 	Order No.	Quick-No.	Iridium 	Order No.
HYOSUNG											
GT 650	650	05 -	CR8E	1275	0,7	CR8EVX	6487	226		CR8EIX	4218
GT 650 R	650	05 -	CR8E	1275	0,7	CR8EVX	6487	226		CR8EIX	4218
GT 650 S	650	05 -	CR8E	1275	0,7	CR8EVX	6487	226		CR8EIX	4218
INDIAN											
all models / Alle Modelle V-Twin		36 - 53	B7HS	5110	0,6	B7HVX	7836	204		BR7HIX	7067
Chief	1450	99 - 01	BPR5ES-11	4424	1,1	BPR5EVX-11	2738			BPR5EIX-11	2115
Scout	1450	01 -	BPR5ES-11	4424	1,1	BPR5EVX-11	2738			BPR5EIX-11	2115
Spirit	1450	01 -	BPR5ES-11	4424	1,1	BPR5EVX-11	2738			BPR5EIX-11	2115
Chief	1650	02 -	BPR5ES-11	4424	1,1	BPR5EVX-11	2738			BPR5EIX-11	2115
ISCH											
Jupiter 13,2kW	346		BP6HS	4511	0,7	BP6HVX	4635			BPR6HIX	4085
Jupiter 20,6kW	346		BP6HS	4511	0,7	BP6HVX	4635			BPR6HIX	4085
6.113.6.114 17,7kW	347		BP6HS	4511	0,7	BP6HVX	4635			BPR6HIX	4085
6.113-01 17,7kW	347		BP6HS	4511	0,7	BP6HVX	4635			BPR6HIX	4085
7.107 16,2kW	347		BP7HS	5111	0,7	BP7HVX	7468			BPR7HIX	5944
Planeta 14,7kW	347		BP7HS	5111	0,7	BP7HVX	7468			BPR7HIX	5944
Planeta 13,2kW	347		BP7HS	5111	0,7	BP7HVX	7468			BPR7HIX	5944
ITALJET											
Pirana, Pulce	50		B6HS	4510	0,5	B6HVX	7435	203		BR6HIX	3419
Tiffany, Winner	50		B5HS	4210	0,5						
Super Range	125		B7HS	5110	0,5	B7HVX	7836	204		BR7HIX	7067
JAWA											
05	50		B6HS	4510	0,6	B6HVX	7435	203		BR6HIX	3419
20	50		B6HS	4510	0,6	B6HVX	7435	203		BR6HIX	3419
21 Sport	50		B6HS	4510	0,6	B6HVX	7435	203		BR6HIX	3419
23 Mustang	50		B6HS	4510	0,6	B6HVX	7435	203		BR6HIX	3419
207 Babetta	50		B4H	4110	0,6						
210	50	01.85 -	B6HS	4510	0,5	B6HVX	7435	203		BR6HIX	3419
210 Babetta	50		B5HS	4210	0,6						
215	50	01.86 -	B6HS	4510	0,5	B6HVX	7435	203		BR6HIX	3419
Moped	50		B8HS	5510	0,5	B8HVX	2634	205		BR8HIX	7001
CZ 125	125	84 -	B8HS	5510	0,5	B8HVX	2634	205		BR8HIX	7001
CZ 125 De Luxe	125	- 84	B8HS	5510	0,5	B8HVX	2634	205		BR8HIX	7001
CZ 175	175	84 -	B8HS	5510	0,5	B8HVX	2634	205		BR8HIX	7001
CZ 175 De Luxe	175	- 84	B8HS	5510	0,5	B8HVX	2634	205		BR8HIX	7001
CZ 250	250	84 -	B8HS	5510	0,5	B8HVX	2634	205		BR8HIX	7001
CZ 250 Single/De Luxe	250	- 84	B8HS	5510	0,5	B8HVX	2634	205		BR8HIX	7001
350 Gespann	350	01.87 -	B6HS	4510	0,5	B6HVX	7435	203		BR6HIX	3419
350/640 Black Style	350	93 -	B8HS	5510	0,5	B8HVX	2634	205		BR8HIX	7001
634	350		B6HS	4510	0,6	B6HVX	7435	203		BR6HIX	3419
638	350		B6HS	4510	0,6	B6HVX	7435	203		BR6HIX	3419
638.5 Gespann	350	01.85 -	B6HS	4510	0,5	B6HVX	7435	203		BR6HIX	3419
639	350		B6HS	4510	0,6	B6HVX	7435	203		BR6HIX	3419
640	350		B6HS	4510	0,6	B6HVX	7435	203		BR6HIX	3419
CZ 350	350	84 -	B8HS	5510	0,5	B8HVX	2634	205		BR8HIX	7001
CZ 350 De Luxe	350	- 84	B8HS	5510	0,5	B8HVX	2634	205		BR8HIX	7001
TS 350	350	09.86 -	B6HS	4510	0,5	B6HVX	7435	203		BR6HIX	3419
Twin Sport	350		B8HS	5510	0,5	B8HVX	2634	205		BR8HIX	7001

				Order No.		Platin 	Order No.	Quick-No. 	Iridium	Order No.
JAWA										
GS 360	360	01.74 - 12.85	B9HS	5810	0,7	B9HVX	2254			
500 DT Speedway	500				0,5	B9EVX	7254		BR9EIX	3981
500 R	500		D8EA	2120	0,5	D8EVX	2850	216	DR8EIX	6681
500 R Spezial	500				0,5	D8EVX	2850		DR8EIX	6681
JCM										
125 Trail	125		BP6ES	7811	0,7	BP6EVX	5832		BPR6EIX	6637
240 Trail	240		BP7ES	2412	0,5	BP7EVX	7270	206	BPR7EIX	4055
333 Trail	333		BP7ES	2412	0,5	BP7EVX	7270	206	BPR7EIX	4055
JOHN DEERE										
Gator 6x4 (ATV)			BMR2A-10	4452	1,0					
Gator 4x2 (ATV)			BPR6ES	7822	0,8	BPR6EVX	6764		BPR6EIX	6637
KARCHER										
KM 170-8 (ATV)	170		DR8EA	7162	0,7	DR8EVX	6354		DR8EIX	6681
KM 250-10 (ATV)	250		CR8HS	7423	0,7	CR8HVX	7236		CR8HIX	7669
KM 250-11 (ATV)	250		CR8HS	7423	0,7	CR8HVX	7236		CR8HIX	7669
KM 250-9 (ATV)	250		CR8HS	7423	0,7	CR8HVX	7236		CR8HIX	7669
KAWASAKI										
AE 50	50	- 82	B6ES	7310	0,8	B6EVX	5136			
AE 50	50	83 -	B8ES	2411	0,8	B8EVX	7051	201	BR8EIX	5044
AR 50	50	93 -	BR8ES	5422	0,8	BR8EVX	1262	207	BR8EIX	5044
AR 50	50	83 - 92	B8ES	2411	0,8	B8EVX	7051	201	BR8EIX	5044
AR 50	50	- 82	B6ES	7310	0,8	B6EVX	5136			
AV 50	50	- 83	D8EA	2120	0,7	D8EVX	2850	216	DR8EIX	6681
AV 50	50	84 -	C6HSA	3228	0,7				CR6HIX	7274
KFX 50 A (SQ)(ATV)	50	03 -	BPR4HS	7823	0,7					
KH 50	50		B6ES	7310	0,8	B6EVX	5136			
KMX 50 (KSR-I)	50	93 -	BR8ES	5422	0,8	BR8EVX	1262	207	BR8EIX	5044
KX 60	60	- 92	B9EG	3530	0,6	B9EGV	5827		BR9EIX	3981
KX 60	60	93 -	BR9EG	3230	0,7	BR9EVX	1265		BR9EIX	3981
KX 65	65		BR10EG	3830	0,6					
AE 80	80	83 -	BPR8ES	3923	0,8	BPR8EVX	5573	213		
AE 80	80	- 82	BP7ES	2412	0,8	BP7EVX	7270	206	BPR7EIX	4055
AN 80	80		C6HSA	3228	0,7				CR6HIX	7274
AR 80	80	83 -	BPR8ES	3923	0,8	BPR8EVX	5573	213		
AR 80	80	- 82	BP7ES	2412	0,8	BP7EVX	7270	206	BPR7EIX	4055
DX 80	80		B8ES	2411	0,8	B8EVX	7051	201	BR8EIX	5044
KD 80	80		B7ES	1111	0,7	B7EVX	6934			
KDX 80	80		B8ES	2411	0,8	B8EVX	7051	201	BR8EIX	5044
KFX 80 (ATV)	80	04 -	BPR4HS	7823	0,6					
KH 80	80		B7ES	1111	0,8	B7EVX	6934			
KMX 80 (KSR-2)	80	93 -	BR8ES	5422	0,8	BR8EVX	1262	207	BR8EIX	5044
KX 80	80	81 - 82	B9ES	2611	0,6	B9EVX	7254	202	BR9EIX	3981
KX 80	80	83 - 91	B9EG	3530	0,6	B9EGV	5827		BR9EIX	3981
KX 80	80	- 80	B8ES	2411	0,8	B8EVX	7051	201	BR8EIX	5044
KX 80 (KX80S7)	80	97 -	R6252K-105	2741	0,6					
KX 80 (KX80V7)	80	97 -	R6252K-105	2741	0,6					
KX 80 /80-2	80	92 -	R6252K-105	2741	0,6					
KX 85	85	01 -	R6252K-105	2741	0,8					

					Order No.		Platin 	Order No.	Quick-No.	Iridium 	Order No.
KAWASAKI											
KX 85-II	85	01 -	R6252K-105	2741	0,8						
KC 90	90		B8ES	2411	0,8	B8EVX	7051	201	BR8EIX	5044	
KC 90 A	90		B8ES	2411	0,8	B8EVX	7051	201	BR8EIX	5044	
KC 90 C	90		B8HS	5510	0,7	B8HVX	2634	205	BR8HIX	7001	
KC 90 D	90		B8HS	5510	0,7	B8HVX	2634	205	BR8HIX	7001	
KE 90	90		B8ES	2411	0,8	B8EVX	7051	201	BR8EIX	5044	
KH 90	90		B8ES	2411	0,8	B8EVX	7051	201	BR8EIX	5044	
KM 90	90		B7HS	5110	0,7	B7HVX	7836	204	BR7HIX	7067	
KC 100	100	80 -	B8ES	2411	0,8	B8EVX	7051	201	BR8EIX	5044	
KD 100	100		B7HS	5110	0,7	B7HVX	7836	204	BR7HIX	7067	
KE 100	100	01.76 -12.79	B8ES	2411	0,8	B8EVX	7051	201	BR8EIX	5044	
KE 100	100	93 -	BR8ES	5422	0,8	BR8EVX	1262	207	BR8EIX	5044	
KH 100	100		B8ES	2411	0,8	B8EVX	7051	201	BR8EIX	5044	
KM 100	100	01.79 -12.81	B7HS	5110	0,7	B7HVX	7836	204	BR7HIX	7067	
KV 100	100		B7HS	5110	0,7	B7HVX	7836	204	BR7HIX	7067	
KX 100	100	92 -	R6252K-105	2741	0,6						
KAZE 110	110	95 -	C6HSA	3228	0,7				CR6HIX	7274	
AR 125	125	01.82 -	BR8ES	5422	0,8	BR8EVX	1262	207	BR8EIX	5044	
BN125A Eliminator	125	97 -	CR8E	1275	0,6	CR8EVX	6487	226	CR8EIX	4218	
DX 125	125				0,6	B9EVX	7254		BR9EIX	3981	
KC 125	125		B6HS	4510	0,7	B6HVX	7435	203	BR6HIX	3419	
KD 125	125		B8HS	5510	0,7	B8HVX	2634	205	BR8HIX	7001	
KDX 125 SR	125		BR8ES	5422	0,8	BR8EVX	1262	207	BR8EIX	5044	
KE 125	125	01.76 -12.83	B8HS	5510	0,8	B8HVX	2634	205	BR8HIX	7001	
KH 125	125	93 -	BR8ES	5422	0,8	BR8EVX	1262	207	BR8EIX	5044	
KH 125	125	01.77 -12.81	BR8ES	5422	0,8	BR8EVX	1262	207	BR8EIX	5044	
KMX 125	125	01.86 -	BR8ES	5422	0,7	BR8EVX	1262	207	BR8EIX	5044	
KS 125	125	01.73 -12.76	B8HS	5510	0,7	B8HVX	2634	205	BR8HIX	7001	
KX 125	125	82 - 84			0,6	B9EVX	7254		BR9EIX	3981	
KX 125	125	91 - 99	R6252K-105	2741	0,6						
KX 125	125	85 - 90			0,6	B10EVX	7335		BR10EIX	6801	
KX 125	125	90 - 91	R6254E-105	3949	0,6						
KX 125	125	03 -				BR9EIX	3981				
KX 125	125	00 -			0,8	BR9EVX	1265		BR9EIX	3981	
KX 125	125	04 -	R6918B-9	2954	0,7						
KX 125 (KX125K4)	125	97 -			0,6	BR9EVX	1265		BR9EIX	3981	
KD 175	175		B9HS	5810	0,7	B9HVX	2254				
KDX 175	175	01.80 -12.84			0,6	BR9EVX	1265		BR9EIX	3981	
KE 175	175	- 80	B9HS	5810	0,7	B9HVX	2254				
KE 175	175	81 -	B7ES	1111	0,8	B7EVX	6934				
KE 175 B	175		B9HS	5810	0,7	B9HVX	2254				
KE 175 D	175		B7ES	1111	0,8	B7EVX	6934				
KLF 185 (ATV)	185		DR8ES	5423	0,7	DR8EVX	6354	217	DR8EIX	6681	
KDX 200	200	93 - 94	BR9ES	5722	0,8	BR9EVX	1265	208	BR9EIX	3981	
KDX 200 H	200	95 -	BR8ES	5422	0,8	BR8EVX	1262	207	BR8EIX	5044	
KMX 200	200	01.88 - 92	BR8ES	5422	0,8	BR8EVX	1262	207	BR8EIX	5044	
Z 200	200	01.77 -12.79	B8ES	2411	0,8	B8EVX	7051	201	BR8EIX	5044	
KLF 220 (ATV)	220	88 - 02	DR8ES	5423	0,7	DR8EVX	6354	217	DR8EIX	6681	
BJ 250A (Estrella)	250	93 - 96	DR8ES	5423	0,7	DR8EVX	6354	217	DR8EIX	6681	
BJ 250 C(Estrella)	250	97 -	DR9EA	3437	0,7	DR9EVX	6361	219	DR9EIX	4772	
EL 250/E/F/Eliminator LX/SE	250	89 -	CR8HSA	2086	0,7	CR8HVX	7236		CR8HIX	7669	
EX 250 F (GPX 250 R)	250	93 -	C8HA	2168	0,7	C8HVX	2672		CR8HIX	7669	



Order No.



Platin



Order No.

Quick-No.







Iridium



Order No.

KAWASAKI

EX 250 H (ZZ-R 250)	250	93 -	CR8HSA	2086	0,7	CR8HVX	7236		CR8HIX	7669
GPX 250 R	250		CR8HSA	2086	0,7	CR8HVX	7236		CR8HIX	7669
GPZ 250 Belt Drive	250		DPR8EA-9	4929	0,9	DPR8EVX-9	2872	221	DPR8EIX-9	2202
GPZ 250 R	250		CR8HS	7423	0,7	CR8HVX	7236		CR8HIX	7669
KDX 250 (ATV)	250		BR8ES	5422	0,8	BR8EVX	1262	207	BR8EIX	5044
KDX 250 (ATV)	250	91 -	BR9ES	5722	0,8	BR9EVX	1265	208	BR9EIX	3981
KDX 250 SR (ATV)	250	92 -	BR8ES	5422	0,8	BR8EVX	1262	207	BR8EIX	5044
KE 250	250		B8ES	2411	0,8	B8EVX	7051	201	BR8EIX	5044
KH 250	250	01.73 -12.79	B9HS	5810	0,7	B9HVX	2254			
KL 250 (A)	250	01.79 -12.83	BR7ES	5122	0,8					
KLF 250 A (ATV)	250	02 -	DR8ES	5423	0,7	DR8EVX	6354	217	DR8EIX	6681
KL 250 (KLR 250)	250	01.83 - 91	DPR9EA-9	5329	0,9	DPR9EVX-9	3854	222	DPR9EIX-9	5545
KLX 250	250	01.80 -12.84	B7ES	1111	0,8	B7EVX	6934			
KLX 250 (KLX250E)	250	93 -	CR8E	1275	0,8	CR8EVX	6487	226	CR8EIX	4218
KR-1R	250		BR10ES	4832	0,8	BR10EVX	3788		BR10EIX	6801
KR-1S	250		BR10ES	4832	0,8	BR10EVX	3788		BR10EIX	6801
KSF 250 A (SQ)	250	87 -	DPR8EA-9	4929	0,9	DPR8EVX-9	2872	221	DPR8EIX-9	2202
KT 250	250		B7HS	5110	0,7	B7HVX	7836	204	BR7HIX	7067
KX 250	250	92 -	R6252E-9	4741	0,9					
KX 250	250	- 91	B9EG	3530	0,6	B9EGV	5827		BR9EIX	3981
KX 250	250	03 -							BR8EIX	5044
KX 250 (KX250K4)	250	97 -				BR8EVX	1262		BR8EIX	5044
KX 250 F	250	04 -	CR8EB	7784	0,6	CR8EVX	6487		CR8EIX	4218
KX 250R	250	05 -			0,8	BR8ECMVX	5567			
LTD 250 Belt Drive	250		DR8ES	5423	0,7	DR8EVX	6354	217	DR8EIX	6681
LX 250	250		BR7ES	5122	0,8					
Z 250	250		BR7ES	5122	0,8					
Z 250 A	250	01.80 -	DR8ES	5423	0,7	DR8EVX	6354	217	DR8EIX	6681
Z 250 B	250		DR8ES	5423	0,7	DR8EVX	6354	217	DR8EIX	6681
Z 250 Belt Drive	250		DPR8EA-9	4929	0,9	DPR8EVX-9	2872	221	DPR8EIX-9	2202
Z 250 C	250	01.80 -	B7ES	1111	0,8	B7EVX	6934			
Z 250 D	250		B7ES	1111	0,8	B7EVX	6934			
Z 250 G	250		B7ES	1111	0,8	B7EVX	6934			
Z 250 J	250		DR8ES	5423	0,7	DR8EVX	6354	217	DR8EIX	6681
Z 250 LTD	250	01.81 -	BR8ES	5422	0,8	BR8EVX	1262	207	BR8EIX	5044
Z 250 T	250		DPR9EA-9	5329	0,9	DPR9EVX-9	3854	222	DPR9EIX-9	5545
ZR 250 (Ballus)	250	93 -	CR9E	6263	0,8	CR9EVX	5943	227	CR9EIX	3521
ZX 250 (ZXR 250)	250	93 -	CR9E	6263	0,8	CR9EVX	5943	227	CR9EIX	3521
KEF 300 A&B (ATV) (SQ)	300	95 -	DR7EA	7839	0,7					
KLF 300 (ATV)	300	88 -	BR8ES	5422	0,8	BR8EVX	1262	207	BR8EIX	5044
KLX 300 R (LX300B5)	300	01 -	CR9E	6263	0,6	CR9EVX	5943	227	CR9EIX	3521
KVF 300 A&B	300	99 - 02	DR8EA	7162	0,7	DR8EVX	6354		DR8EIX	6681
MULE 500/ KAF 300 A&B (UV)	300	92 - 96	BPR5ES	7422	0,8	BPR5EVX	4875		BPR5EIX	6597
GPZ 305 Belt Drive	305	01.83 -	DPR9EA-9	5329	0,9	DPR9EVX-9	3854	222	DPR9EIX-9	5545
Z 305	305		D8EA	2120	0,7	D8EVX	2850	216	DR8EIX	6681
KVF 360 A & B (ATV)	360	02 -	DPR8EA-9	4929	0,9	DPR8EVX-9	2872	221	DPR8EIX-9	2202
EN 400 A	400		DR8ES	5423	0,7	DR8EVX	6354	217	DR8EIX	6681
GPZ 400	400		DPR9EA-9	5329	0,9	DPR9EVX-9	3854	222	DPR9EIX-9	5545
GPZ 400 F	400		DPR9EA-9	5329	0,9	DPR9EVX-9	3854	222	DPR9EIX-9	5545
GPZ 400 F II	400		DPR9EA-9	5329	0,9	DPR9EVX-9	3854	222	DPR9EIX-9	5545
KFX 400 (ATV)	400	03 -	CR7E	4578	0,8			225	CR7EIX	7385
KFX 400 A (SQ) (ATV)	400	03 -	CR8E	1275	0,7	CR8EVX	6487	226	CR8EIX	4218

					Order No.		Gold-Palladium	Platin 	Order No.	Quick-No.	Iridium 	Order No.
KAWASAKI												
KH 400	400		B8HS	5510	0,7	B8HVX	2634	205	BR8HIX	7001		
KLE 400	400	93 -	DR8EA	7162	0,7	DR8EVX	6354		DR8EIX	6681		
KLF 400 B (ATV)	400	93 - 99	DPR8EA-9	4929	0,9	DPR8EVX-9	2872	221	DPR8EIX-9	2202		
KVF 400 C&D (ATV)	400	99 - 02	DPR8EA-9	4929	0,9	DPR8EVX-9	2872	221	DPR8EIX-9	2202		
KX 400	400				0,6	B9EVX	7254		BR9EIX	3981		
KXF 400 A	400	03 -	CR8EA		0,6							
LTD 400	400		DR8ES	5423	0,7	DR8EVX	6354	217	DR8EIX	6681		
Z 400	400	01.76 -12.81	BR7ES	5122	0,8							
Z 400 A/B/C/D/G/H	400		B7ES	1111	0,8	B7EVX	6934					
Z 400 F	400	83 -	DR8ES	5423	0,7	DR8EVX	6354	217	DR8EIX	6681		
Z 400 F	400		DPR9EA-9	5329	0,9	DPR9EVX-9	3854	222	DPR9EIX-9	5545		
Z 400 F-II	400		DPR9EA-9	5329	0,9	DPR9EVX-9	3854	222	DPR9EIX-9	5545		
Z 400 J	400		DR8EA	7162	0,7	DR8EVX	6354		DR8EIX	6681		
Z 400 J (I)	400		D8EA	2120	0,7	D8EVX	2850	216	DR8EIX	6681		
Z 400 K	400		DR7ES	3123	0,7							
Z 400 LTD	400		BR7ES	5122	0,8							
Z 400 M	400		DR8EA	7162	0,7	DR8EVX	6354		DR8EIX	6681		
ZL 400 (Eliminator 400SE)	400	93 -	DR8ES	5423	0,7	DR8EVX	6354	217	DR8EIX	6681		
ZR 400	400	84 -	DR8ESL	2923	0,7	DR8EVX	6354	218	DR8EIX	6681		
ZR 400	400	- 83	DR7ES	3123	0,7							
ZR 400-C (Zephyr 400)	400	93 -	DPR9EA-9	5329	0,9	DPR9EVX-9	3854	222	DPR9EIX-9	5545		
ZR 400-D (Xanthus)	400	93 -	CR9EK	4548	0,8				230	CR9EIX	3521	
ZX 400 (Z 400-F2)	400	93 -	DPR9EA-9	5329	0,9	DPR9EVX-9	3854	222	DPR9EIX-9	5545		
ZX 400 (ZXR400R, ZZR400)	400	93 -	CR9EK	4548	0,8				230	CR9EIX	3521	
ZXR 400	400		CR9EK	4548	0,8				230	CR9EIX	3521	
Z 440	440	01.80 -12.85	BR7ES	5122	0,8							
Z 440 H (I)	440		BR7ES	5122	0,8							
EN 450 A (I)	450		DR8ES	5423	0,7	DR8EVX	6354	217	DR8EIX	6681		
LTD 450	450	01.85 -	DR8ES	5423	0,7	DR8EVX	6354	217	DR8EIX	6681		
Mule 1000 / KAF 450B (UV)	450	90 - 95	D6EA	7512	0,7							
EN 500	500	90 -	DR9EA	3437	0,7	DR9EVX	6361	219	DR9EIX	4772		
ER-5 (ER500A1)(ER500C1)	500	97 -	DR9EA	3437	0,7	DR9EVX	6361	219	DR9EIX	4772		
ER-5 (ER500B1)(ER500D1)	500	97 -	DR9EA	3437	0,7	DR9EVX	6361	219	DR9EIX	4772		
EX 500 (GPZ 500S EN 500)	500	93 -	DR8ES	5423	0,7	DR8EVX	6354	217	DR8EIX	6681		
GPX 500 R	500	01.89 -	DR8ES	5423	0,7	DR8EVX	6354	217	DR8EIX	6681		
GPZ 500 R	500		DR8ES	5423	0,7	DR8EVX	6354	217	DR8EIX	6681		
GPZ 500 S	500		DR8ES	5423	0,7	DR8EVX	6354	217	DR8EIX	6681		
GPZ 500 S (EX500D)	500	94 -	DR9EA	3437	0,7	DR9EVX	6361	219	DR9EIX	4772		
GPZ 500 S (EX500E4)	500	97 -	DR9EA	3437	0,7	DR9EVX	6361	219	DR9EIX	4772		
GPZ 500 S (I)	500		D9EA	2420	0,7	D9EVX	2834		DR9EIX	4772		
GRZ 500 S (EX500E)	500		D9EA	2420	0,7	D9EVX	2834		DR9EIX	4772		
KH 500	500		B9HS-10	3626	1,0							
KLE 500	500	90 - 04	DR9EA	3437	0,7	DR9EVX	6361	219	DR9EIX	4772		
KLE 500	500	05 -	DR9EA	3437	0,7	DR9EVX	6361	219	DR9EIX	4772		
KLR 500	500		DPR8EA-9	4929	0,9	DPR8EVX-9	2872	221	DPR8EIX-9	2202		
KX 500	500	93 -	BR8EG	3130	0,6							
LE 500 A	500		DR9EA	3437	0,8	DR9EVX	6361	219	DR9EIX	4772		
Z 500	500		DR8EA	7162	0,7	DR8EVX	6354		DR8EIX	6681		
ZL 500	500		DR8ES	5423	0,7	DR8EVX	6354	217	DR8EIX	6681		
ZR 500	500		DR8ESL	2923	0,7	DR8EVX	6354	218	DR8EIX	6681		
ZZ-R 500	500		CR9E	6263	0,8	CR9EVX	5943	227	CR9EIX	3521		
Mule 2010 / KAF 540C (UV)	540	90 - 93	BPR5ES	7422	0,6	BPR5EVX	4875		BPR5EIX	6597		



Order No.



Gold-Palladium



Platin

Order No.



Quick-No.







Iridium



Order No.

KAWASAKI

GPZ 550	550		DPR9EA-9	5329	0,9	DPR9EVX-9	3854	222	DPR9EIX-9	5545
GPZ 550 Unitrack (I)	550		D8EA	2120	0,7	D8EVX	2850	216	DR8EIX	6681
GT 550	550	01.83 -	DR8ES	5423	0,7	DR8EVX	6354	217	DR8EIX	6681
LTD 550	550	01.80 - 12.85	DR8ES	5423	0,7	DR8EVX	6354	217	DR8EIX	6681
Z 550	550		DR8ES	5423	0,7	DR8EVX	6354	217	DR8EIX	6681
Zephyr (ZR550B8)	550	97 -	DR9EA	3437	0,7	DR9EVX	6361	219	DR9EIX	4772
ZR 550 B Zephyr	550	91 -	DR9EA	3437	0,8	DR9EVX	6361	219	DR9EIX	4772
ZX 550 A1	550		DPR9EA-9	5329	0,9	DPR9EVX-9	3854	222	DPR9EIX-9	5545
Eliminator 600 (ZL600B)	600	95 -	DR9EA	3437	0,7	DR9EVX	6361	219	DR9EIX	4772
GPX 600	600		DR8ES	5423	0,8	DR8EVX	6354	217	DR8EIX	6681
GPZ 600	600		DR8ES	5423	0,7	DR8EVX	6354	217	DR8EIX	6681
GPZ 600 R (I)	600		D9EA	2420	0,7	D9EVX	2834		DR9EIX	4772
KL 600	600		DPR8EA-9	4929	0,9	DPR8EVX-9	2872	221	DPR8EIX-9	2202
KL 600 R-AI (I)	600		D8EA	2120	0,7	D8EVX	2850	216	DR8EIX	6681
KLR 600	600	85 -	DPR8EA-9	4929	0,9	DPR8EVX-9	2872	221	DPR8EIX-9	2202
KLR 600	600	- 84	DR8ES	5423	0,7	DR8EVX	6354	217	DR8EIX	6681
KLR 600 EL (I)	600		DP9EA-9	6629	0,9	DP9EVX-9	3331		DPR9EIX-9	5545
ZL 600	600	01.86 -	DR8ES	5423	0,7	DR8EVX	6354	217	DR8EIX	6681
ZL 600 (ZL600B/B1)	600	95 -	DR9EA	3437	0,7	DR9EVX	6361	219	DR9EIX	4772
ZX 600 A (I)	600		D9EA	2420	0,7	D9EVX	2834		DR9EIX	4772
ZX-6R Ninja (ZX 600 G)	600	98 -	CR9E	6263	0,7	CR9EVX	5943	227	CR9EIX	3521
ZX-6R Ninja (ZX600F1/F3)	600	95 -	CR9E	6263	0,8	CR9EVX	5943	227	CR9EIX	3521
ZX-6R Ninja (ZX 600 H Kat)	600	98 -	CR9E	6263	0,7	CR9EVX	5943	227	CR9EIX	3521
ZX-6R Ninja (Kat.)	600	03 -	CR9E	6263	0,8	CR9EVX	5943	227	CR9EIX	3521
ZX-6R Ninja (Kat.) (Zx600J1H)	600	00 -	CR9E	6263	0,8	CR9EVX	5943	227	CR9EIX	3521
ZX-6RR	600	04 -	CR9E	6263	0,8	CR9EVX	5943	227	CR9EIX	3521
ZZ-R 600	600	90 -	CR9E	6263	0,8	CR9EVX	5943	227	CR9EIX	3521
ZZ-R 600 (ZX600E9)	600	01 -	CR9E	6263	0,7	CR9EVX	5943	227	CR9EIX	3521
ZZ-R 600 (ZX600E/E5)	600	93 -	CR9E	6263	0,8	CR9EVX	5943	227	CR9EIX	3521
Mule 2510 / KAF 620A&C (UV)	620	93 - 02	BMR2A	7677	0,6					
Mule 3010 / KAF 620E&G (UV)	620	01 -	BPR2ES	2264	0,6					
ZX-6R	636	05 -	CR9E	6263	0,8	CR9EVX	5943	227	CR9EIX	3521
Ninja ZX-6R (ZX636B)	636	03 -	CR9E	6263	0,8	CR9EVX	5943	227	CR9EIX	3521
ZX-6RR	636	05 -	CR9E	6263	0,8	CR9EVX	5943	227	CR9EIX	3521
Ninja ZX-6RR (ZX600K)	636	03 -	CR9E	6263	0,8	CR9EVX	5943	227	CR9EIX	3521
KL 650 (KLR 650/Tengai)	650	93 -	DPR8EA-9	4929	0,9	DPR8EVX-9	2872	221	DPR8EIX-9	2202
KLR 650	650	09.86 - 94	DPR8EA-9	4929	0,9	DPR8EVX-9	2872	221	DPR8EIX-9	2202
KLR 650 (KL650C1/C3)	650	95 -	DPR8EA-9	4929	0,9	DPR8EVX-9	2872	221	DPR8EIX-9	2202
KLX 650 (KLX650C)	650	93 -	DPR8EA-9	4929	0,9	DPR8EVX-9	2872	221	DPR8EIX-9	2202
KLX 650 R	650	98 -	DPR8EA-9	4929	0,9	DPR8EVX-9	2872	221	DPR8EIX-9	2202
KLX 650 R (KLX650A)	650	93 - 96	DPR8EA-9	4929	0,9	DPR8EVX-9	2872	221	DPR8EIX-9	2202
KVF 650 4X4 (ATV)	650	05 -	CR7E	4578	0,8			225	CR7EIX	7385
KVF 650 A (ATV)	650	00 -	CR7E	4578	0,8			225	CR7EIX	7385
W 650 (EJ650A1)	650	99 -	CR9E	6263	0,8	CR9EVX	5943	227	CR9EIX	3521
Z 650	650		BR7ES	5122	0,8					
Z 650 F-B	650		B8ES	2411	0,7	B8EVX	7051	201	BR8EIX	5044
KFV 700 (ATV)	700	04 -	CR7E	4578	0,8			225	CR7EIX	7385
KFX 700 (ATV) Quad	700	04 -	CR7E	4578	0,8			225	CR7EIX	7385
KSV 700 (ATV)	700	04 -	CR7E	4578	0,8			225	CR7EIX	7385
LTD 700	700		BR8ES	5422	0,8	BR8EVX	1262	207	BR8EIX	5044
Z 700	700		BR8ES	5422	0,8	BR8EVX	1262	207	BR8EIX	5044
750 Turbo	750	01.73 - 12.86			0,6	BR9EVX	1265		BR9EIX	3981

					Order No.		Gold-Palladium	Platin 	Order No.	Quick-No.	Iridium 	Order No.
KAWASAKI												
GPX 750 R	750	01.87 -	DR8ES	5423	0,7	DR8EVX	6354	217	DR8EIX	6681		
GPX 750 R (I)	750		DR8ESL	2923	0,7	DR8EVX	6354	218	DR8EIX	6681		
GPZ 750	750	01.82 -	BR9ES	5722	0,8	BR9EVX	1265	208	BR9EIX	3981		
GPZ 750 R	750	01.85 -	DR8ES	5423	0,7	DR8EVX	6354	217	DR8EIX	6681		
GT 750	750	01.82-12.87	BR8ES	5422	0,8	BR8EVX	1262	207	BR8EIX	5044		
KVF 750 (ATV)	750	05 -	CR7E	4578	0,8			225	CR7EIX	7385		
LTD 750 4 Cyl.	750	01.82-12.87	BR8ES	5422	0,8	BR8EVX	1262	207	BR8EIX	5044		
VN 750 Twin	750		DP7EA-9	5129	0,9	DP7EVX-9	7682	220	DP7EIX-9	7803		
VN 750 Vulcan	750		DP7EA-9	5129	0,9	DP7EVX-9	7682	220	DP7EIX-9	7803		
Z 2	750		B8ES	2411	0,8	B8EVX	7051	201	BR8EIX	5044		
Z 750	750		BR8ES	5422	0,8	BR8EVX	1262	207	BR8EIX	5044		
Z 750	750	04 -	CR9EK	4548	0,7			230	CR9EIX	3521		
Z 750 (GT750)	750	93 -	DR8ES	5423	0,7	DR8EVX	6354	217	DR8EIX	6681		
Z 750 B	750		BR8ES	5422	0,8	BR8EVX	1262	207	BR8EIX	5044		
Z 750 D	750		B8ES	2411	0,8	B8EVX	7051	201	BR8EIX	5044		
Z 750 E	750		BR8ES	5422	0,8	BR8EVX	1262	207	BR8EIX	5044		
Z 750 GP	750		BR8ES	5422	0,8	BR8EVX	1262	207	BR8EIX	5044		
Z 750 H	750		BR8ES	5422	0,8	BR8EVX	1262	207	BR8EIX	5044		
Z 750 L	750		BR8ES	5422	0,8	BR8EVX	1262	207	BR8EIX	5044		
Z 750 LTD	750		BR8ES	5422	0,8	BR8EVX	1262	207	BR8EIX	5044		
Z 750 LTD Belt Drive	750		BPR6ES	7822	0,8	BPR6EVX	6764		BPR6EIX	6637		
Z 750 LTD Twin.	750		BPR6ES	7822	0,8	BPR6EVX	6764		BPR6EIX	6637		
Z 750 M	750		BR6ES	4922	0,8							
Z 750 S	750		BR6ES	4922	0,8							
ZR-7 (ZR750F1)	750	99 -	DR9EA	3437	0,7	DR9EVX	6361	219	DR9EIX	4772		
ZR 750 C Zephyr	750	91 - 00	DR8ES	5423	0,7	DR8EVX	6354	217	DR8EIX	6681		
ZR 750 S	750	05 -	CR9EK	4548	0,7		230		CR9EIX	3521		
ZR 750 D1/2 Zephyr	750	96 - 00	DR9EA	3437	0,7	DR9EVX	6361	219	DR9EIX	4772		
ZR-7S (ZR750F1)(ZR750-H1)	750	99 -	DR9EA	3437	0,7	DR9EVX	6361	219	DR9EIX	4772		
ZX 750 J	750		CR9E	6263	0,8	CR9EVX	5943	227	CR9EIX	3521		
ZX 750 N1 Ninja ZX-7RR	750	96 -	CR9E	6263	0,8	CR9EVX	5943	227	CR9EIX	3521		
ZX 750 P1/P2 Ninja ZX-7R	750	96 -	CR9E	6263	0,8	CR9EVX	5943	227	CR9EIX	3521		
ZX-7R Ninja (ZX750P6)	750	00 -	CR9E	6263	0,7	CR9EVX	5943	227	CR9EIX	3521		
ZXR 750	750	09.88 -	CR9E	6263	0,8	CR9EVX	5943	227	CR9EIX	3521		
ZXR 750 R	750	90 -	CR9E	6263	0,8	CR9EVX	5943	227	CR9EIX	3521		
ZXR 750 R (ZX750L/M)	750	93 -	CR9E	6263	0,8	CR9EVX	5943	227	CR9EIX	3521		
VN 800 Drifter (VN800E1)	800	01 -	CR7E	4578	0,8			225	CR7EIX	7385		
VN 800 Drifter (VN800C1)	800	99 - 00	CR8E	1275	0,8	CR8EVX	6487	226	CR8EIX	4218		
VN 800 (VN800A)	800	95 -	CR8E	1275	0,8	CR8EVX	6487	226	CR8EIX	4218		
VN 800 (VN800A3)	800	97 -	CR8E	1275	0,8	CR8EVX	6487	226	CR8EIX	4218		
VN 800 B1/B2	800	96 -	CR8E	1275	0,8	CR8EVX	6487	226	CR8EIX	4218		
Vulcan 800	800	95 -	CR8E	1275	0,8	CR8EVX	6487	226	CR8EIX	4218		
GPZ 900 R	900		DR8ES	5423	0,7	DR8EVX	6354	217	DR8EIX	6681		
GPZ 900 R (I)	900		D9EA	2420	0,6	D9EVX	2834		DR9EIX	4772		
Ninja ZX-9R	900	98 -	CR9EK	4548	0,7			230	CR9EIX	3521		
Z 1	900		B8ES	2411	0,8	B8EVX	7051	201	BR8EIX	5044		
Z 900	900	01.73-12.76	B8ES	2411	0,8	B8EVX	7051	201	BR8EIX	5044		
ZX 900 B/B4 (Ninja ZX-9R)	900	94 - 97	CR9EK	4548	0,7			230	CR9EIX	3521		
ZX 900 C (Ninja ZX-9R)	900	98 - 99	CR9EK	4548	0,7			230	CR9EIX	3521		
ZX 900 D (Kat.) (Ninja ZX-9R)	900	98 - 99	CR9EK	4548	0,7			230	CR9EIX	3521		
ZX-9R	900	03 -	CR9EK	4548	0,7			230	CR9EIX	3521		
ZX 900 E1H (Kat.) (Ninja ZX-9R)	900	00 -	CR9EK	4548	0,7			230	CR9EIX	3521		



Order No.



Gold-Palladium

Platin



Order No.

Quick-No.







Iridium



Order No.

KAWASAKI

1000 GTR	1000		DR8ES	5423	0,7	DR8EVX	6354	217	DR8EIX	6681	
1000 GTR (ZG1000A12)	1000	97 -	DR9EA	3437	0,7	DR9EVX	6361	219	DR9EIX	4772	
1000 GTR (ZGTO0A)	1000	94 -	DR9EA	3437	0,7	DR9EVX	6361	219	DR9EIX	4772	
1000 GTR (I)	1000		D9EA	2420	0,7	D9EVX	2834		DR9EIX	4772	
A 1000 R1	1000		BR8ES	5422	0,8	BR8EVX	1262	207	BR8EIX	5044	
GPZ 1000 AZ (I)	1000		B8ES	2411	0,7	B8EVX	7051	201	BR8EIX	5044	
GPZ 1000 R (I)	1000		D9EA	2420	0,7	D9EVX	2834		DR9EIX	4772	
GPZ 1000 RX	1000		DR8ES	5423	0,7	DR8EVX	6354	217	DR8EIX	6681	
GPZ 1000 RX (I)	1000		D9EA	2420	0,7	D9EVX	2834		DR9EIX	4772	
KLX 1000	1000	04 -	CR8EK	3478	0,7						
KZ 1000 Police	1000	93 -	BR8ES	5422	0,8	BR8EVX	1262	207	BR8EIX	5044	
ST 1000 (I)	1000		B8ES	2411	0,7	B8EVX	7051	201	BR8EIX	5044	
Z 1000	1000	- 80	B8ES	2411	0,8	B8EVX	7051	201	BR8EIX	5044	
Z 1000	1000	81 -	BR8ES	5422	0,8	BR8EVX	1262	207	BR8EIX	5044	
Z 1000	1000	03 -	CR9EK	4548	0,8				230	CR9EIX	3521
Z 1000 ES (I)	1000		B8ES	2411	0,8	B8EVX	7051	201	BR8EIX	5044	
Z 1000 J (I)	1000		BR8ES	5422	0,8	BR8EVX	1262	207	BR8EIX	5044	
Z1R 1000 (I)	1000		B8ES	2411	0,7	B8EVX	7051	201	BR8EIX	5044	
ZL 1000	1000	09.86 -	DR8ES	5423	0,7	DR8EVX	6354	217	DR8EIX	6681	
ZX 10	1000	87 - 90	CR9E	6263	0,8	CR9EVX	5943	227	CR9EIX	3521	
ZX-10 R Ninja	1000	04 -							CR9EIA-9	6289	
ZZR 1100 Kat (ZX1100G)	1052	98 -	CR9E	6263	0,7	CR9EVX	5943	227	CR9EIX	3521	
GPZ 1100	1100		BR8ES	5422	0,8	BR8EVX	1262	207	BR8EIX	5044	
GPZ 1100 (ZX1100E1E1H)	1100	95 -	CR9EK	4548	0,8				230	CR9EIX	3521
GPZ 1100 ABS (ZX1100F1)	1100	97 -	CR9EK	4548	0,8				230	CR9EIX	3521
LTD 1100	1100		BR8ES	5422	0,8	BR8EVX	1262	207	BR8EIX	5044	
Z 1100	1100		BR8ES	5422	0,8	BR8EVX	1262	207	BR8EIX	5044	
Zephyr 1100 (ZR1100A)	1100		CR9E	6263	0,8	CR9EVX	5943	227	CR9EIX	3521	
Zephyr 1100 (ZRT10A)	1100	92 -	CR9E	6263	0,8	CR9EVX	5943	227	CR9EIX	3521	
ZRX 1100 (ZR1100C1)(ZRT10C)	1100	97 - 00	CR9EK	4548	0,8				230	CR9EIX	3521
Zephyr (ZR 1100 B1)	1100	96 -	CR9E	6263	0,8	CR9EVX	5943	227	CR9EIX	3521	
ZX 1100 F1	1100	96 -	CR9EK	4548	0,8				230	CR9EIX	3521
ZZR 1100 (ZXT10C)	1100	90 - 92	CR9E	6263	0,8	CR9EVX	5943	227	CR9EIX	3521	
ZZR 1100 (ZX1100D5)	1100	97 -	CR9E	6263	0,8	CR9EVX	5943	227	CR9EIX	3521	
ZZR 1100 (ZXT10D)	1100	93 - 96	CR9E	6263	0,8	CR9EVX	5943	227	CR9EIX	3521	
ZG 1200 (Voyager XII)	1200	93 -	DPR8EA-9	4929	0,9	DPR8EVX-9	2872	221	DPR8EIX-9	2202	
ZRX 1200 (ZR1200C1P)	1200	01 -	CR9EK	4548	0,6				230	CR9EIX	3521
ZRX 1200 R (ZR1200C1P)	1200	01 -	CR9EK	4548	0,6				230	CR9EIX	3521
ZRX 1200 S (ZR1200C1P)	1200	01 -	CR9EK	4548	0,6				230	CR9EIX	3521
ZX-12R Ninja (Kat.) (ZX1200A1H)	1200	00 -	CR9EKPA	7785	0,7						
ZZ-R 1200 (ZX1200C1)	1200	02 -	CR9E	6263	0,7	CR9EVX	5943	227	CR9EIX	3521	
Z 1300	1300	80 -	BPR6ES	7822	0,8	BPR6EVX	6764		BPR6EIX	6637	
Z 1300	1300	79 -	B8ES	2411	0,8	B8EVX	7051	201	BR8EIX	5044	
VN 1500F Classic	1471	98 - 00	DPR5EA-9	2887	0,9						
VN 1500 Mean Streak (P1)	1500	02 -	DPR6EA-9	5531	0,9						
VN 1500 Drifter (VN1500J1)	1500	99 - 00	DPR5EA-9	2887	0,9						
VN 1500 Drifter (VN1500R1)	1500	01 -	DPR6EA-9	5531	0,9						
VN-15 A/B (VN-1500/SE/C/D2)	1500		DPR7EA-9	5129	0,9	DPR7EVX-9	7682	220	DPR7EIX-9	7803	
VN 1600 Classic	1600	03 -	DPR6EA-9	5531	0,9						
VN 1600 Classic Tour	1600	05 -	DPR6EA-9	5531	0,9						
VN 1600 Mean Streak	1600	04 -	DPR6EA-9	5531	0,9						
VN 2000	2053	04 -	IZFR6F-11								

					Order No.		Platin 	Order No.	Quick-No.	Iridium 	Order No.
KRAMER											
250		250		B9ES	2611	0,6	B9EVX	7254	202	BR9EIX	3981
KREIDLER											
Enduro		125	00 -	DP7EA-9	5629	0,9	DPR7EVX-9	7682		DPR7EIX-9	7803
Mustang		125		DR8EA	7162	0,7	DR8EVX	6354		DR8EIX	6681
KTM											
50 GP		50	10.81 -	B7HS	5110	0,6	B7HVX	7836	204	BR7HIX	7067
50 GXE		50		B9EG	3530	0,6	B9EGV	5827		BR9EIX	3981
50 GXR		50				0,6	B9EVX	7254		BR9EIX	3981
50 SX Pro Junior LC Beta Engine		50	03 -	BR8ECM	3035	0,6					
50 Junior Adventure		50	02 -	BR8HS	4322	0,6	BR8HVX	6265	212	BR8HIX	7001
50 ME		50	10.81 -	B7HS	5110	0,6	B7HVX	7836	204	BR7HIX	7067
50 Mini Adventure		50	02 -	BR8HS	4322	0,6	BR8HVX	6265	212	BR8HIX	7001
50 Mini Adventure GS getrennte Schmierung		50	02 -	BR8HS	4322	0,6	BR8HVX	6265	212	BR8HIX	7001
50 Mini Adventure		50	01 - 01	B8HS	5510	0,6	B8HVX	2634	205	BR8HIX	7001
50 MLS		50		B6HS	4510	0,6	B6HVX	7435	203	BR6HIX	3419
50 MMS		50		B7HS	5110	0,6	B7HVX	7836	204	BR7HIX	7067
50 MS		50	10.81 -	B6HS	4510	0,6	B6HVX	7435	203	BR6HIX	3419
50 RSL		50		B7HS	5110	0,6	B7HVX	7836	204	BR7HIX	7067
50 SX Pro Senior LC		50	03 -	BR8ECM	3035	0,6					
50 Senior		50	03 -	BR8ECM	3035	0,6					
50 Senior Adventure		50	02 - 02	BR8HS	4322	0,6	BR8HVX	6265	212	BR8HIX	7001
50 SX Junior		50	01 - 01	B8HS	5510	0,6	B8HVX	2634	205	BR8HIX	7001
50 SX Senior		50	01 - 01	B8HS	5510	0,6	B8HVX	2634	205	BR8HIX	7001
50 SX Junior LC		50	02 - 02	BR10EG	3830	0,6					
50 SX Senior LC		50	02 - 02	BR10EG	3830	0,6					
50 SXR Adventure		50	98 - 01	B8HS	5510	0,6	B8HVX	2634	205	BR8HIX	7001
50 SXR Pro Senior		50	98 - 01	B8HS	5510	0,6	B8HVX	2634	205	BR8HIX	7001
50 XR Pro Junior		50	98 - 01	B8HS	5510	0,6	B8HVX	2634	205	BR8HIX	7001
Bora 25		50	10.81 -	BP6HS	4511	0,6	BP6HVX	4635		BPR6HIX	4085
Bora 50		50		B6HS	4510	0,6	B6HVX	7435	203	BR6HIX	3419
Comet		50	09.76 -	B6HS	4510	0,6	B6HVX	7435	203	BR6HIX	3419
Crazy (CH)		50		BP5HS	4111	0,6					
Foxi		50		B5HS	4210	0,6					
Foxi (DK)		50		B7HS	5110	0,6	B7HVX	7836	204	BR7HIX	7067
Hobby		50	10.81 -	BP6ES	7811	0,6	BP6EVX	5832		BPR6EIX	6637
Pony		50	10.81 -	B5HS	4210	0,6					
Pony (CH)		50	10.81 -	B7HS	5110	0,6	B7HVX	7836	204	BR7HIX	7067
Postmofa		50		BP6ES	7811	0,6	BP6EVX	5832		BPR6EIX	6637
S5-E		50	99 -	B8HS	5510	0,6	B8HVX	2634	205	BR8HIX	7001
S5-GS Pro Junior		50	99 -	B8HS	5510	0,6	B8HVX	2634	205	BR8HIX	7001
S5-GS Pro Senior		50	99 -	B8HS	5510	0,6	B8HVX	2634	205	BR8HIX	7001
SM 25		50		BP6HS	4511	0,6	BP6HVX	4635		BPR6HIX	4085
Squadra		50		BP6ES	7811	0,6	BP6EVX	5832		BPR6EIX	6637
60 SX		60	98 -	R7234-10	5558	0,6					
65 SX Beta Engine		65	03 -	BR8ECM	3035	0,6					
65 SX		65	98 - 00	R7234-10	5558	0,6					
65 SX		65	01 - 02			0,6	BR10EG	4832			
80 Chopper		80		B9HS	5810	0,6	B9HVX	2254			
80 Enduro		80		B10EG	3630	0,6	B10EGV	5927			
80 IGS		80				0,6	B10EGV	5927			



Order No.



Gold-Palladium

Platin



Order No.



Quick-No.







Iridium















Order No.







KTM										
80 IMX	80				0,6	B10EGV	5927			
80 PL	80	06.83 - 12.84	B8HS	5510	0,6	B8HVX	2634	205	BR8HIX	7001
80 RL	80	10.81 -	B8HS	5510	0,6	B8HVX	2634	205	BR8HIX	7001
80 RLS	80	10.81 -	B9HS	5810	0,6	B9HVX	2254			
80 RLW	80	10.81 -	B9HS	5810	0,6	B9HVX	2254			
80 RS	80	10.81 -	B8HS	5510	0,6	B8HVX	2634	205	BR8HIX	7001
Bora 80	80	10.81 -	B8HS	5510	0,6	B8HVX	2634	205	BR8HIX	7001
85 IGS	85				0,6	B10EGV	5927			
85 IMX	85				0,6	B10EGV	5927			
85 SX	85	04 -			0,6	BR10ECMVX	2457			
GS 100	100	08.73 - 08.76	B9HCS	2721	0,6					
MC 100	100	08.73 - 08.76	B9HCS	2721	0,6					
105 SX	105	.04 -			0,7	BR10ECMVX	2457			
125 EGS	125	93 -			0,6	B10EGV	5927			
125 EGS	125	99 -	R6918B-8	4492	0,6					
125 EGS	125	98 -	R6918B-8	4492	0,6					
125 Enduro	125		B10EG	3630	0,6	B10EGV	5927			
125 EXC	125	96 - 08.97			0,6	B10EGV	5927			
125 EXC	125	08.97 - 98	R6918B-8	4492	0,6					
125 EXC	125	93 - 95			0,6	B10EGV	5927			
125 EXC	125	98 - 99	R6918B-8	4492	0,6					
125 EXC	125	01 -			0,6	BR9EVX	1265		BR9EIX	3981
125 EXC	125	99 - 00	R6918B-8	4492	0,6					
125 EXE	125	99 -	BR8HS	4322	0,6	BR8HVX	6265	212	BR8HIX	7001
125 LC 2 (Langgewinde)	125	96 - 00	BR9ES	5722	0,6	BR9EVX	1265	208	BR9EIX	3981
125 LC2 (Kurzgewinde)	125	00 -	BR8HS	4322	0,6	BR8HVX	6265	212	BR8HIX	7001
125 MX	125				0,6	B10EGV	5927			
125 Sting	125	98 -	BR8ES	5422	0,7	BR8EVX	1262	207	BR8EIX	5044
125 Supermoto	125	99 -	BR8HS	4322	0,6	BR8HVX	6265	212	BR8HIX	7001
125 SX (98er)	125	08.97 - 98	R6918B-8	4492	0,6					
125 SX	125	93 - 95			0,6	B10EGV	5927			
125 SX	125	96 - 08.97	BR10EG	3830	0,6					
125 SX	125	02 -			0,6	BR9EVX	1265		BR9EIX	3981
125 SX	125	01 - 01			0,7	BR8EVX	1262		BR8EIX	5044
125 SX	125	99 - 00	R6918B-8	4492	0,6					
125 TXC	125				0,6	B10EGV	5927			
GS 125 12,7 mm	125		B8HS	5510	0,6	B8HVX	2634	205	BR8HIX	7001
GS 125 19,0 mm	125				0,6	B10EGV	5927			
MC 125 12,7 mm	125		B8HS	5510	0,6	B8HVX	2634	205	BR8HIX	7001
MC 125 19,0 mm	125		B9EG	3530	0,6	B9EGV	5827		BR9EIX	3981
MC 125 GP	125		B10HS	2399	0,6	B10HVX	2940			
GS 175	175		B8HS	5510	0,6	B8HVX	2634	205	BR8HIX	7001
MC 175	175		B8HS	5510	0,6	B8HVX	2634	205	BR8HIX	7001
200 EGS	200	99 -	BR8EG	3130	0,6					
200 EGS	200	98 -	BR8EG	3130	0,6					
200 EXC	200	98 - 99	BR8EG	3130	0,6					
200 EXC	200	99 - 01	BR9EG	3230	0,6					
200 EXC	200	02 -	BR8EG	3130	0,6					
200 MXC	200	99 -	BR8EG	3130	0,6					
200 SX	200	03 -			0,6	BR9EVX	1265		BR9EIX	3981
250 DXC	250				0,6	B9EGV	5827			
250 EGS	250	93 - 95			0,6	B9EGV	5827			







									KTM	
	Order No.	Order No.	Order No.	Order No.	Order No.	Order No.	Order No.	Order No.	Order No.	Order No.
250 EGS	250	97 -	BR8ECM	3035	0,6					
250 EGS	250	99 -	BR8ECM	3035	0,6					
250 EGS	250	98 -	BR8ECM	3035	0,8					
250 Enduro	250		B10EG	3630	0,6	B10EGV	5927			
250 EXC	250	97 - 98	BR8ECM	3035	0,6					
250 EXC	250	96 - 96			0,6	B8EGV	5627			
250 EXC	250	93 - 95			0,6	B9EGV	5827			
250 EXC Enduro Competition	250	03 -	BR7ES	5122	0,6	BR7EVX	4556			
250 EXC Racing	250	03 -	DCPR8E	4179	0,6	DCPR8EVX	2265	DCPR8EIX	6546	
250 EXC Racing GS	250	03 -	DCPR8E	4179	0,6	DCPR8EVX	2265	DCPR8EIX	6546	
250 EXC / Sixt Days	250	98 - 01	BR8ECM	3035	0,8					
250 EXC Racing / Sixt Days	250	02 - 02	CR8EK	3478	0,6					
250 EXC Racing	250	02 - 02	CR8EK	3478	0,6					
250 MX	250				0,6	B9EGV	5827			
250 SX	250	93 - 95			0,6	B9EGV	5827			
250 SX	250	96 -	BR8EG	3130	0,6					
250 SX	250	97 - 98	BR8ECM	3035	0,6					
250 SX	250	98 - 99	BR8ECM	3035	0,8					
250 SX	250	99 -	BR8ECM	3035	0,6					
250 SX 4Takt	250	05 -	CR9EKB		0,7					
250 SXC	250	99 -	BR8ECM	3035	0,6					
250 TXC	250				0,6	B9EGV	5827			
GS 250 12,7 mm	250		B9HS	5810	0,6	B9HVX	2254			
GS 250 19,0 mm	250				0,6	B9EGV	5827			
MC 250 12,7 mm	250		B9HS	5810	0,6	B9HVX	2254			
MC 250 19,0 mm	250		B9EG	3530	0,6	B9EGV	5827	BR9EIX	3981	
MC 250 GP 12,7 mm	250		B9HS	5810	0,6	B9HVX	2254			
MC 250 GP 19,0 mm	250		B9EG	3530	0,6	B9EGV	5827	BR9EIX	3981	
300 DXC	300	90 - 95			0,6	B9EGV	5827			
300 EGS	300	97 -	BR8ECM	3035	0,6					
300 EGS	300	93 - 95			0,6	B9EGV	5827			
300 EGS	300	99 -	BR8ECM	3035	0,6					
300 EXC	300	93 - 95			0,6	B9EGV	5827			
300 EXC	300	96 - 96			0,6	B8EGV	5627			
300 EXC	300	97 - 98	BR8ECM	3035	0,6					
300 EXC Enduro Competition	300	03 -	BR7ES	5122	0,6	BR7EVX	4556			
300 EXC / Sixt Days	300	99 -	BR8ECM	3035	0,6					
300 GS	300	90 - 95			0,6	B9EGV	5827			
300 LC (I)	300		B10EG	3630	0,6	B10EGV	5927			
300 MX	300	- 95			0,6	B9EGV	5827			
300 MXC	300	97 - 02	BR8ECM	3035	0,6					
300 MXC	300	03 -	BR7ES	5122	0,6	BR7EVX	4556			
300 SX	300	93 - 95			0,6	B9EGV	5827			
300 SX	300	99 -	BR8ECM	3035	0,6					
300 TXC	300	- 95			0,6	B9EGV	5827			
350 GS	350				0,6	B9EVX	7254	BR9EIX	3981	
350 MX	350				0,6	B9EVX	7254	BR9EIX	3981	
LC4 18kW	350	- 93	D8EA	2120	0,6	D8EVX	2850	216	DR8EIX	6681
LC4 30kW	350	- 93	D8EA	2120	0,6	D8EVX	2850	216	DR8EIX	6681
LC4 350 EGS	350	93 -	D8EA	2120	0,6	D8EVX	2850	216	DR8EIX	6681
LC4 350 EXC	350	93 -	D8EA	2120	0,6	D8EVX	2850	216	DR8EIX	6681
360 EGS	360	97 -	BR8ECM	3035	0,6					

					Order No.		Platin 	Order No.	Quick-No.		Order No.	KTM
GS 500 2Stroke	500		B10EG	3630	0,6	B10EGV	5927					
GS 500 4Stroke	500		D8EA	2120	0,6	D8EVX	2850	216		DR8EIX	6681	
MC 500 2Stroke	500		B10EG	3630	0,6	B10EGV	5927					
MC 500 4Stroke	500		D8EA	2120	0,6	D8EVX	2850	216		DR8EIX	6681	
520 EXC Racing / Six Days	520	99 -04.02	CR8EK	3478	0,7							
520 EXC Racing	520	05.02 -	DCPR8E	4179	0,6	DCPR8EVX	2265			DCPR8EIX	6546	
520 SX Racing	520	99 -04.02	CR8EK	3478	0,7							
520 SX Racing	520	05.02 -	DCPR8E	4179	0,6	DCPR8EVX	2265			DCPR8EIX	6546	
525 EXC Racing GS	525	03 -	DCPR8E	4179	0,6	DCPR8EVX	2265			DCPR8EIX	6546	
525 EXC Racing	525	03 -	DCPR8E	4179	0,6	DCPR8EVX	2265			DCPR8EIX	6546	
525 MXC	525	03 -	DCPR8E	4179	0,6	DCPR8EVX	2265			DCPR8EIX	6546	
525 SX Racing	525	03 -	DCPR8E	4179	0,6	DCPR8EVX	2265			DCPR8EIX	6546	
540 DXC	540	-			0,6	B10EGV	5927					
540 MX	540		B9ES	2611	0,6	B9EVX	7254	202		BR9EIX	3981	
540 SXC	540	99 -	D8EA	2120	0,6	D8EVX	2850	216		DR8EIX	6681	
540 SXC	540	98 -	D8EA	2120	0,6	D8EVX	2850	216		DR8EIX	6681	
540 SXC 20kW	540	99 -	D8EA	2120	0,6	D8EVX	2850	216		DR8EIX	6681	
540 SXS Racing	540	02 -	CR8EK	3478	0,7							
600 4 TGS	600		DP9EA-9	6629	0,9	DP9EVX-9	3331			DPR9EIX-9	5545	
600 4 TMX	600		DP9EA-9	6629	0,9	DP9EVX-9	3331			DPR9EIX-9	5545	
600 4 TXC	600		DP9EA-9	6629	0,9	DP9EVX-9	3331			DPR9EIX-9	5545	
600 Country	600		D8EA	2120	0,6	D8EVX	2850	216		DR8EIX	6681	
600 Enduro	600		D8EA	2120	0,6	D8EVX	2850	216		DR8EIX	6681	
600 MX	600		D8EA	2120	0,6	D8EVX	2850	216		DR8EIX	6681	
LC4 Enduro 17kW	600	- 87	D8EA	2120	0,6	D8EVX	2850	216		DR8EIX	6681	
LC4 Enduro 36kW	600	- 87	D8EA	2120	0,6	D8EVX	2850	216		DR8EIX	6681	
LC4 600 EGS	600	93 -	D8EA	2120	0,6	D8EVX	2850	216		DR8EIX	6681	
LC4 600 EXC	600	93 -	D8EA	2120	0,6	D8EVX	2850	216		DR8EIX	6681	
620 Duke	609	94 -	D8EA	2120	0,6	D8EVX	2850	216		DR8EIX	6681	
LC4 620 Supercompetition	609	01 -04.02	DR8EA	7162	0,7	DR8EVX	6354			DR8EIX	6681	
LC4 620 SC Supermoto	609	01 -04.02	DR8EA	7162	0,7	DR8EVX	6354			DR8EIX	6681	
LC4 612 EGS	612	93 -	D8EA	2120	0,6	D8EVX	2850	216		DR8EIX	6681	
LC4 612 EXC	612	93 -	D8EA	2120	0,6	D8EVX	2850	216		DR8EIX	6681	
620 Duke-E	620	97 -	DR8EA	7162	0,6	DR8EVX	6354			DR8EIX	6681	
620 EGS	620	97 -	D8EA	2120	0,6	D8EVX	2850	216		DR8EIX	6681	
620 EGS-E	620	97 -	DR8EA	7162	0,6	DR8EVX	6354			DR8EIX	6681	
620 LS4 Rally	620	97 -	D8EA	2120	0,6	D8EVX	2850	216		DR8EIX	6681	
620 LS-E	620	97 -	DR8EA	7162	0,6	DR8EVX	6354			DR8EIX	6681	
620 SC	620	96 -	D8EA	2120	0,6	D8EVX	2850	216		DR8EIX	6681	
620 SC	620	98 -	D8EA	2120	0,6	D8EVX	2850	216		DR8EIX	6681	
620 Supercompetition	620	97 -04.02	D8EA	2120	0,6	D8EVX	2850	216		DR8EIX	6681	
620 SX	620	96 -	D8EA	2120	0,6	D8EVX	2850	216		DR8EIX	6681	
620 SX	620	99 -	D8EA	2120	0,6	D8EVX	2850	216		DR8EIX	6681	
LC4 620 SX	620	94 -	D8EA	2120	0,6	D8EVX	2850	216		DR8EIX	6681	
LC4 620 EXC	620	94 -	D8EA	2120	0,6	D8EVX	2850	216		DR8EIX	6681	
LC4 620 EGS	620	94 -	D8EA	2120	0,6	D8EVX	2850	216		DR8EIX	6681	
LC 4 Supercopetition Supermoto	620	05.02 -	DCPR8E	4179	0,6	DCPR8EVX	2265			DCPR8EIX	6546	
LC4 Super Competition	620	00 -04.02	DPR8EA-9	4929	0,9	DPR8EVX-9	2872	221		DPR8EIX-9	2202	
Supermoto Competition 620	620	98 - 00	D8EA	2120	0,6	D8EVX	2850	216		DR8EIX	6681	
625 SC	625	02 -	DPR8EA-9	4929	0,9	DPR8EVX-9	2872	221		DPR8EIX-9	2202	
625 SXC Hard Enduro	625	03 -	DCPR8E	4179	0,6	DCPR8EVX	2265			DCPR8EIX	6546	
625 SXC Super Moto	625	02 -	DCPR8E	4179	0,6	DCPR8EVX	2265			DCPR8EIX	6546	

				Order No.		Platin 	Order No.	Quick-No. 	Iridium 	Order No.
KTM										
640 Duke 2	625	02-04.02	DPR8EA-9	4929	0,9	DPR8EVX-9	2872	221	DPR8EIX-9	2202
640 Supermoto Spezial Edition	625	03 -	DCPR8E	4179	0,6	DCPR8EVX	2265		DCPR8EIX	6546
Adventure R 640	625	98 - 01	DR8EA	7162	0,7	DR8EVX	6354		DR8EIX	6681
Duke 2	625	00-04.02	DPR8EA-9	4929	0,9	DPR8EVX-9	2872	221	DPR8EIX-9	2202
Duke 640	625	98 - 01	DR8EA	7162	0,7	DR8EVX	6354		DR8EIX	6681
Duke II	625	99 - 01	DR8EA	7162	0,7	DR8EVX	6354		DR8EIX	6681
Duke II	625	05.02 -	DCPR8E	4179	0,6	DCPR8EVX	2265		DCPR8EIX	6546
LC 4 E Supermoto	625	05.02 - 02	DCPR8E	4179	0,6	DCPR8EVX	2265		DCPR8EIX	6546
LC4-640 Hard Enduro	625	03 -	DCPR8E	4179	0,6	DCPR8EVX	2265		DCPR8EIX	6546
LC4 Prestige Supermoto	625	03 -	DCPR8E	4179	0,6	DCPR8EVX	2265		DCPR8EIX	6546
640 LC4 Adventure	625	02-04.02	DPR8EA-9	4929	0,9	DPR8EVX-9	2872	221	DPR8EIX-9	2202
LC4 640	625	98 - 00	DR8EA	7162	0,7	DR8EVX	6354		DR8EIX	6681
LC4- 640 Adverture	625	01-04.02	DR8EA	7162	0,7	DR8EVX	6354		DR8EIX	6681
640 LC4	625	99 - 01	DR8EA	7162	0,7	DR8EVX	6354		DR8EIX	6681
640 LC4 Super Moto	625	02-04.02	DPR8EA-9	4929	0,9	DPR8EVX-9	2872	221	DPR8EIX-9	2202
640 LC4	625	02-04.02	DPR8EA-9	4929	0,9	DPR8EVX-9	2872	221	DPR8EIX-9	2202
LC4- E	625	00 - 00	DPR8EA-9	4929	0,9	DPR8EVX-9	2872	221	DPR8EIX-9	2202
LC4 Adventure	625	00 - 00	DPR8EA-9	4929	0,9	DPR8EVX-9	2872	221	DPR8EIX-9	2202
640 LC4-E SM Prestige	625	02-04.02	DPR8EA-9	4929	0,9	DPR8EVX-9	2872	221	DPR8EIX-9	2202
640 LC4-E Six Days	625	02-04.02	DPR8EA-9	4929	0,9	DPR8EVX-9	2872	221	DPR8EIX-9	2202
LC4- E 640 Supermoto	625	01 - 01	DR8EA	7162	0,7	DR8EVX	6354		DR8EIX	6681
LC4- E 640 Enduro	625	01 - 01	DR8EA	7162	0,7	DR8EVX	6354		DR8EIX	6681
LC 4 E	625	05.02 -	DCPR8E	4179	0,6	DCPR8EVX	2265		DCPR8EIX	6546
LC4 640 Duke II	625	03 -	DCPR8E	4179	0,6	DCPR8EVX	2265		DCPR8EIX	6546
LC 4 Adventure R	625	05.02 -	DCPR8E	4179	0,6	DCPR8EVX	2265		DCPR8EIX	6546
LC4- E Supermoto	625	00 - 00	DPR8EA-9	4929	0,9	DPR8EVX-9	2872	221	DPR8EIX-9	2202
660 Rallye	650	02-04.02	DR9EA	3437	0,6	DR9EVX	6361	219	DR9EIX	4772
660 Super Moto Factory Replica	650	02 -	DR9EA	3437	0,6	DR9EVX	6361	219	DR9EIX	4772
LC4 660	650	03 -	DR9EA	3437	0,6	DR9EVX	6361	219	DR9EIX	4772
660 LC4 Rallye	650	99 - 01	DR8EA	7162	0,6	DR8EVX	6354		DR8EIX	6681
Rallye	650	05.02 - 02	DCPR8E	4179	0,6	DCPR8EVX	2265		DCPR8EIX	6546
Rallye	650	00 - 01	DPR8EA-9	4929	0,9	DPR8EVX-9	2872	221	DPR8EIX-9	2202
950 Adventure	950	03 -	CR8EK	3478	0,7					
950 Adventure S	950	03 -	CR8EK	3478	0,7					
950 Supermoto	950	05 -	CR8EK	3478	0,7					
LC8 950 Rally	950	03 -	CR8EK	3478	0,7					
990 Duke	1000	09.04 -	DCPR8E	4179	0,6	DCPR8EVX	2265		DCPR8EIX	6546
990 Superduke	1000	05 -	DCPR8E	4179	0,6	DCPR8EVX	2265		DCPR8EIX	6546
KUANG YANG										
GS7E - Movie	50		BP6HSA	1046	0,6				BPR6HIX	4085
KA 50	50		BP6HSA	1046	0,6				BPR6HIX	4085
KA 50G	50		BP6HSA	1046	0,6				BPR6HIX	4085
KYMCO										
MX 50 (Quad)(ATV)	50	01 -	BR8HSA	5539	0,5	BR8HVX	6265		BR8HIX	7001
Tomos TX 50	50	01 -	B6HS	4510	0,6	B6HVX	7435	203	BR6HIX	3419
Hipster 125 4Takt/4Ventil	125	01 -	CR8E	1275	0,6	CR8EVX	6487	226	CR8EIX	4218
Hipster 125 2Ventil	125		DR8EA	7162	0,7	DR8EVX	6354		DR8EIX	6681
Pulsar 125 4Takt	125	01 -	DR8EA	7162	0,7	DR8EVX	6354		DR8EIX	6681
Stryker 125 II	125	02 -	DR8EA	7162	0,7	DR8EVX	6354		DR8EIX	6681
Stryker 125	125	99 -	DR8EA	7162	0,7	DR8EVX	6354		DR8EIX	6681

					Order No.		Gold-Palladium	Platin 	Order No.	Quick-No.		Iridium	Order No.
KYMCO													
Zing 125	125	99 -	DR8EA	7162	0,7	DR8EVX	6354		6354		DR8EIX		6681
MX 150 (Quad)(ATV)	150	01 -	DR8EA	7162	0,7	DR8EVX	6354		6354		DR8EIX		6681
KXR 250 (Quad)(ATV)	250	01 -	DPR7EA-9	5129	0,9	DDR7EVX-9	7682	220	7682	220	DPR7EIX-9		7803
MXU 250 (ATV)	250	05 -	DPR7EA-9	5129	0,9	DDR7EVX-9	7682	220	7682	220	DPR7EIX-9		7803
Venox 250 4Takt	250	01 -	DPR7EA-9	5129	0,9	DDR7EVX-9	7682	220	7682	220	DPR7EIX-9		7803
LAMBRETTA													
3V77/4V/5V	50		B6HS	4510	0,5	B6HVX	7435	203	7435	203	BR6HIX		3419
Puma Cross,Trial	50		B6HS	4510	0,5	B6HVX	7435	203	7435	203	BR6HIX		3419
125,Lince,Linea,SX	125		B7ES	1111	0,5	B7EVX	6934		6934				
150 GP	150		B7ES	1111	0,5	B7EVX	6934		6934				
Spezial 150	150		B7ES	1111	0,5	B7EVX	6934		6934				
200 GP	200		B7ES	1111	0,5	B7EVX	6934		6934				
200,Jet,Lince,Mensa-Expres	200		B7ES	1111	0,5	B7EVX	6934		6934				
Pony,SX	200		B7ES	1111	0,5	B7EVX	6934		6934				
LAVERDA													
CU125 Ride, GS125 Lesmo	125		B8ES	2411	0,5	B8EVX	7051	201	7051	201	BR8EIX		5044
Custom, Strada	125		B9ES	2611	0,5	B9EVX	7254	202	7254	202	BR9EIX		3981
LB125 Uno	125		B8ES	2411	0,5	B8EVX	7051	201	7051	201	BR8EIX		5044
350 Alpino	350		D9EA	2420	0,5	D9EVX	2834		2834		DR9EIX		4772
500 Alpino/Montjuich	500		D9EA	2420	0,5	D9EVX	2834		2834		DR9EIX		4772
OR600 Atlas	600		D8EA	2120	0,6	D8EVX	2850	216	2850	216	DR8EIX		6681
650 Ghost	650	96 -	DPR8EA-9	4929	0,9	DPR8EVX-9	2872	221	2872	221	DPR8EIX-9		2202
650 Ghost Strike	650	96 -	DPR8EA-9	4929	0,9	DPR8EVX-9	2872	221	2872	221	DPR8EIX-9		2202
650 Ghost Legend	650	96 -	DPR8EA-9	4929	0,9	DPR8EVX-9	2872	221	2872	221	DPR8EIX-9		2202
650 Sport	650	95 -	DPR9EA-9	5329	0,9	DPR9EVX-9	3854	222	3854	222	DPR9EIX-9		5545
650 Ghost	668	97 -	DPR9EA-9	5329	0,9	DPR9EVX-9	3854	222	3854	222	DPR9EIX-9		5545
668	668	96 -	DPR9EA-9	5329	0,9	DPR9EVX-9	3854	222	3854	222	DPR9EIX-9		5545
668	668		DPR8EA-9	4929	0,9	DPR8EVX-9	2872	221	2872	221	DPR8EIX-9		2202
668	668	97 -	DPR9EA-9	5329	0,9	DPR9EVX-9	3854	222	3854	222	DPR9EIX-9		5545
750 S Formula	750	98 -	DCPR9E	2641	0,6	DCPR9EVX	6436		6436		DCPR9EIX		2316
750/GS/GT/S/SFC/SF-2D	750		BP8ES	2912	0,5	BP8EVX	2671		2671				
770 GTL	750		BP7ES	2412	0,5	BP7EVX	7270	206	7270	206	BPR7EIX		4055
SF,SF Competizione/SS	750		B10EGV	5927	0,5	B10EVX	7335		7335				
SF2-10, SF3	750		B8ES	2411	0,5	B8EVX	7051	201	7051	201	BR8EIX		5044
1000 RGS	1000		B8ES	2411	0,6	B8EVX	7051	201	7051	201	BR8EIX		5044
1000/Jarama/Jota/SC/CE/CL	1000		B8ES	2411	0,6	B8EVX	7051	201	7051	201	BR8EIX		5044
1200/Mirage/TS	1200		B8ES	2411	0,6	B8EVX	7051	201	7051	201	BR8EIX		5044
LEM													
2001 Bay	50		BP6ES	7811	0,5	BP6EVX	5832		5832		BPR6EIX		6637
2001 Matic	50		BP6ES	7811	0,5	BP6EVX	5832		5832		BPR6EIX		6637
2001 Variant	50		BP6ES	7811	0,5	BP6EVX	5832		5832		BPR6EIX		6637
Cayman	50		B7HS	5110	0,5	B7HVX	7836	204	7836	204	BR7HIX		7067
Cayman LC	50		B7HS	5110	0,5	B7HVX	7836	204	7836	204	BR7HIX		7067
Chembol Form	50		B6ES	7310	0,5	B6EVX	5136		5136				
Chembol Raid	50		B6ES	7310	0,5	B6EVX	5136		5136				
Cinno Corsa 8 / 10	50		B6HS	4510	0,5	B6HVX	7435	203	7435	203	BR6HIX		3419
Conдор	50		B7HS	5110	0,5	B7HVX	7836	204	7836	204	BR7HIX		7067
Convert	50		B5HS	4210	0,5								
CR 3	50	97 -	B7HS	5110	0,5	B7HVX	7836	204	7836	204	BR7HIX		7067

				Order No.		Platin 	Order No.	Quick-No.	Iridium 	Order No.
LEM										
L 2	50		B7HS	5110	0,5	B7HVX	7836	204	BR7HIX	7067
LX 1	50		B8HS	5510	0,6	B8HVX	2634	205	BR8HIX	7001
LX 2	50	97 -	B7HS	5110	0,5	B7HVX	7836	204	BR7HIX	7067
LX 2-S Sport	50	97 -	B7HS	5110	0,5	B7HVX	7836	204	BR7HIX	7067
LX 2-SR	50		B7HS	5110	0,5	B7HVX	7836	204	BR7HIX	7067
LX 4 New	50		B9ES	2611	0,6	B9EVX	7254	202	BR9EIX	3981
Piesse	50		B5HS	4210	0,5					
Pizeta	50		B5HS	4210	0,5					
Pratikal Kit SL	50		B5HS	4210	0,5					
R 2 Air	50		B10EGV	5927	0,5					
R 3 Air	50		B10EGV	5927	0,5					
R 3 Usa	50		B10EGV	5927	0,5					
SK 6	50		B7HS	5110	0,5	B7HVX	7836	204	BR7HIX	7067
SM 2	50		B7HS	5110	0,5	B7HVX	7836	204	BR7HIX	7067
SM 3	50		B10EGV	5927	0,5					
Stratos	50		B6ES	7310	0,5	B6EVX	5136			
Stratos Matic	50		B5HS	4210	0,5					
MAGNI										
Sfida	1000		BP6ES	7811	0,6	BP6EVX	5832		BPR6EIX	6637
MAICO										
GS 125	125		B9ES	2611	0,5	B9EVX	7254	202	BR9EIX	3981
MC 125	125		B9ES	2611	0,5	B9EVX	7254	202	BR9EIX	3981
SG 125	125		B9ES	2611	0,5	B9EVX	7254	202	BR9EIX	3981
250	250	94 -	B9ES	2611	0,5	B9EVX	7254	202	BR9EIX	3981
GM Star 250	250		B9ES	2611	0,5	B9EVX	7254	202	BR9EIX	3981
GM Star E 250	250		B9ES	2611	0,5	B9EVX	7254	202	BR9EIX	3981
GS 250	250		B9ES	2611	0,5	B9EVX	7254	202	BR9EIX	3981
GSE 250	250	-05.83	B9ES	2611	0,5	B9EVX	7254	202	BR9EIX	3981
MC 250	250		B9ES	2611	0,5	B9EVX	7254	202	BR9EIX	3981
320	320	94 -	B9ES	2611	0,6	B9EVX	7254	202	BR9EIX	3981
GS 400	400	01.74 -05.83	B9ES	2611	0,5	B9EVX	7254	202	BR9EIX	3981
MC 400	400		B9ES	2611	0,5	B9EVX	7254	202	BR9EIX	3981
440	440	94 -	B9ES	2611	0,6	B9EVX	7254	202	BR9EIX	3981
GSE 490	490	-05.83	B9ES	2611	0,5	B9EVX	7254	202	BR9EIX	3981
MC 490	490	-05.83	B9ES	2611	0,5	B9EVX	7254	202	BR9EIX	3981
500	500	94 -	B9ES	2611	0,5	B9EVX	7254	202	BR9EIX	3981
GS 500	500		B9ES	2611	0,5	B9EVX	7254	202	BR9EIX	3981
GS Star 500	500		B9ES	2611	0,5	B9EVX	7254	202	BR9EIX	3981
GS Star E 500	500		B9ES	2611	0,5	B9EVX	7254	202	BR9EIX	3981
MC 500	500		B9ES	2611	0,5	B9EVX	7254	202	BR9EIX	3981
685 Gespann	685	94 -			0,6	B10EVX	7335			
MALAGUTI										
Custon Fox	50		B6HS	4510	0,5	B6HVX	7435	203	BR6HIX	3419
Fifty Top	50		B9ES	2611	0,5	B9EVX	7254	202	BR9EIX	3981
Grizzly RCW4/RCW50/RXC10	50		B6HS	4510	0,5	B6HVX	7435	203	BR6HIX	3419
Grizzly RCX50,Ranocchio	50		B6HS	4510	0,5	B6HVX	7435	203	BR6HIX	3419
RCX 4	50		B8HS	5510	0,5	B8HVX	2634	205	BR8HIX	7001
RCX 10 Automatic	50		B6HS	4510	0,5	B6HVX	7435	203	BR6HIX	3419
RCX 12 Automatic	50		B8HS	5510	0,5	B8HVX	2634	205	BR8HIX	7001

					Order No.		Platin 	Order No.	Quick-No.	Iridium 	Order No.
MALAGUTI											
Dune Enduro 75	75		B7ES	1111	0,5	B7EVX	6934				
RST 75 Turismo	75		B7ES	1111	0,5	B7EVX	6934				
Runner 125 Rally	125		B9ES	2611	0,5	B9EVX	7254	202		BR9EIX	3981
Runner 125 YLC	125		B8ES	2411	0,5	B8EVX	7051	201		BR8EIX	5044
MARS											
M 25	25		B5HS	4210	0,8						
Enduro Dakarino	50		B8HCS	2621	0,6						
M 25 Mini Califo	50		B5HS	4210	0,8						
M 50	50		B5HS	4210	0,8						
MK 50	50		BPR6HSA	4632	0,6					BPR6HIX	4085
MBK											
41	49		B6HS	4510	0,5	B6HVX	7435	203		BR6HIX	3419
50 EV	49		B6HS	4510	0,5	B6HVX	7435	203		BR6HIX	3419
50 EW	49		B6HS	4510	0,5	B6HVX	7435	203		BR6HIX	3419
50 L	49		B6HS	4510	0,5	B6HVX	7435	203		BR6HIX	3419
50 S	49		B6HS	4510	0,5	B6HVX	7435	203		BR6HIX	3419
50 VL	49		B6HS	4510	0,5	B6HVX	7435	203		BR6HIX	3419
50 VS	49		B6HS	4510	0,5	B6HVX	7435	203		BR6HIX	3419
51 New West	49		B6HS	4510	0,5	B6HVX	7435	203		BR6HIX	3419
51 S	49		B6HS	4510	0,5	B6HVX	7435	203		BR6HIX	3419
51 SL	49		B6HS	4510	0,5	B6HVX	7435	203		BR6HIX	3419
51 Super	49		B6HS	4510	0,5	B6HVX	7435	203		BR6HIX	3419
51 Super Special	49		B6HS	4510	0,5	B6HVX	7435	203		BR6HIX	3419
51 V	49		B6HS	4510	0,5	B6HVX	7435	203		BR6HIX	3419
51 VL	49		B6HS	4510	0,5	B6HVX	7435	203		BR6HIX	3419
88	49		B6HS	4510	0,5	B6HVX	7435	203		BR6HIX	3419
88 IP	49		B6HS	4510	0,5	B6HVX	7435	203		BR6HIX	3419
88 IU	49		B6HS	4510	0,5	B6HVX	7435	203		BR6HIX	3419
89	49		B6HS	4510	0,5	B6HVX	7435	203		BR6HIX	3419
Active	49		BPR7HS	6422	0,7	BPR7HVX	2938	215		BPR7HIX	5944
AV 40	49		B6HS	4510	0,5	B6HVX	7435	203		BR6HIX	3419
AV 42	49		B6HS	4510	0,5	B6HVX	7435	203		BR6HIX	3419
AV 44	49		B6HS	4510	0,5	B6HVX	7435	203		BR6HIX	3419
AV 46	49		B6HS	4510	0,5	B6HVX	7435	203		BR6HIX	3419
AV 48	49		B6HS	4510	0,5	B6HVX	7435	203		BR6HIX	3419
AV 56	49		B6HS	4510	0,5	B6HVX	7435	203		BR6HIX	3419
AV 59	49		B6HS	4510	0,5	B6HVX	7435	203		BR6HIX	3419
AV 65	49		B6HS	4510	0,5	B6HVX	7435	203		BR6HIX	3419
AV 68	49		B6HS	4510	0,5	B6HVX	7435	203		BR6HIX	3419
AV 76	49		B6HS	4510	0,5	B6HVX	7435	203		BR6HIX	3419
AV 79	49		B6HS	4510	0,5	B6HVX	7435	203		BR6HIX	3419
AV 85	49		B6HS	4510	0,5	B6HVX	7435	203		BR6HIX	3419
AV 88	49		B6HS	4510	0,5	B6HVX	7435	203		BR6HIX	3419
AV 89	49		B6HS	4510	0,5	B6HVX	7435	203		BR6HIX	3419
AV 92	49		B6HS	4510	0,5	B6HVX	7435	203		BR6HIX	3419
AV 98	49		B6HS	4510	0,5	B6HVX	7435	203		BR6HIX	3419
Cady	49		B6HS	4510	0,5	B6HVX	7435	203		BR6HIX	3419
CF	49		B6HS	4510	0,5	B6HVX	7435	203		BR6HIX	3419
Champ	49		B6HS	4510	0,5	B6HVX	7435	203		BR6HIX	3419
Daytona Beach	49		B6HS	4510	0,5	B6HVX	7435	203		BR6HIX	3419



Order No.



Gold-Palladium

Platin



Order No.

Quick-No.







Iridium















Order No.

MBK

Daytona Cruiser	49		B6HS	4510	0,5	B6HVX	7435	203	BR6HIX	3419
FXK	49		B8ES	2411	0,5	B8EVX	7051	201	BR8EIX	5044
G 40	49		B6HS	4510	0,5	B6HVX	7435	203	BR6HIX	3419
G 50	49		B6HS	4510	0,5	B6HVX	7435	203	BR6HIX	3419
Hobby IV	49		BP6ES	7811	0,5	BP6EVX	5832		BPR6EIX	6637
KW Magnum	49		B6HS	4510	0,5	B6HVX	7435	203	BR6HIX	3419
M 1	49		B6HS	4510	0,5	B6HVX	7435	203	BR6HIX	3419
M 1L	49		B6HS	4510	0,5	B6HVX	7435	203	BR6HIX	3419
M 1P	49		B6HS	4510	0,5	B6HVX	7435	203	BR6HIX	3419
M 1PR	49		B6HS	4510	0,5	B6HVX	7435	203	BR6HIX	3419
M 1PRT	49		B6HS	4510	0,5	B6HVX	7435	203	BR6HIX	3419
M 1PRTS	49		B6HS	4510	0,5	B6HVX	7435	203	BR6HIX	3419
Mobylett	49		B6HS	4510	0,5	B6HVX	7435	203	BR6HIX	3419
N 40	49		B6HS	4510	0,5	B6HVX	7435	203	BR6HIX	3419
N 50	49		B6HS	4510	0,5	B6HVX	7435	203	BR6HIX	3419
Rock	49		B6HS	4510	0,5	B6HVX	7435	203	BR6HIX	3419
SP 50	49		B6HS	4510	0,5	B6HVX	7435	203	BR6HIX	3419
SP 92	49		B6HS	4510	0,5	B6HVX	7435	203	BR6HIX	3419
SP 93	49		B6HS	4510	0,5	B6HVX	7435	203	BR6HIX	3419
SP 94	49		B6HS	4510	0,5	B6HVX	7435	203	BR6HIX	3419
SP 98	49		B6HS	4510	0,5	B6HVX	7435	203	BR6HIX	3419
SP 99	49		B6HS	4510	0,5	B6HVX	7435	203	BR6HIX	3419
Weeky	49		B7HS	5110	0,5	B7HVX	7836	204	BR7HIX	7067
X 1	49		B6HS	4510	0,5	B6HVX	7435	203	BR6HIX	3419
X 1L	49		B6HS	4510	0,5	B6HVX	7435	203	BR6HIX	3419
X 7L	49		B6HS	4510	0,5	B6HVX	7435	203	BR6HIX	3419
X 7S	49		B6HS	4510	0,5	B6HVX	7435	203	BR6HIX	3419
X 7VL	49		B6HS	4510	0,5	B6HVX	7435	203	BR6HIX	3419
X 7VS	49		B6HS	4510	0,5	B6HVX	7435	203	BR6HIX	3419
ZX	49		BR7HS	4122	0,5			211	BR7HIX	7067
151 L	50	01.79 -07.83	B6HS	4510	0,5	B6HVX	7435	203	BR6HIX	3419
151 LB	50	01.79 -07.83	B6HS	4510	0,5	B6HVX	7435	203	BR6HIX	3419
151 LC	50	01.79 -07.83	B6HS	4510	0,5	B6HVX	7435	203	BR6HIX	3419
50 R	50		B7HS	5110	0,5	B7HVX	7836	204	BR7HIX	7067
50 VL	50	01.71 -12.80	B6HS	4510	0,5	B6HVX	7435	203	BR6HIX	3419
50 VLC	50	01.71 -12.80	B6HS	4510	0,5	B6HVX	7435	203	BR6HIX	3419
51 SU	50	01.81 -07.83	B6HS	4510	0,5	B6HVX	7435	203	BR6HIX	3419
89	50	-07.83	B7HS	5110	0,5	B7HVX	7836	204	BR7HIX	7067
93	50		B7HS	5110	0,5	B7HVX	7836	204	BR7HIX	7067
98	50	-07.83	B7HS	5110	0,5	B7HVX	7836	204	BR7HIX	7067
99	50		B7HS	5110	0,5	B7HVX	7836	204	BR7HIX	7067
D50	50		B7HS	5110	0,5	B7HVX	7836	204	BR7HIX	7067
Monty MB3V	50	01.77 -07.83	BP6ES	7811	0,5	BP6EVX	5832		BPR5EIX	6597
Monty SP3V	50	-11.81	BP6ES	7811	0,6	BP6EVX	5832		BPR6EIX	6637
Monty SP3V	50	12.81 -	B6HS	4510	0,5	B6HVX	7435	203	BR6HIX	3419
SP 94 TT	50		B7HS	5110	0,5	B7HVX	7836	204	BR7HIX	7067
X power	50	03 -	BR9ES	5722	0,8	BR9EVX	1265	208	BR9EIX	3981
D75	75		B8HS	5510	0,5	B8HVX	2634	205	BR8HIX	7001
125 12,7 mm	125		B8HS	5510	0,5	B8HVX	2634	205	BR8HIX	7001
125 19,0 mm	125		B8ES	2411	0,5	B8EVX	7051	201	BR8EIX	5044
250	250		B8ES	2411	0,5	B8EVX	7051	201	BR8EIX	5044
350	350	04.73 -04.79	B8ES	2411	0,5	B8EVX	7051	201	BR8EIX	5044

					Order No.		Gold-Palladium	Platin 	Order No.	Quick-No.	Iridium 	Order No.
MBK												
350 E	350		B8ES	2411	0,5	B8EVX	7051	201	BR8EIX			5044
350 Injection	350		B8ES	2411	0,5	B8EVX	7051	201	BR8EIX			5044
MECATECNO												
Chic,Funny/2,Cuc	50		B6HS	4510	0,5	B6HVX	7435	203	BR6HIX			3419
Dragon Fly School Boy	50		B6HS	4510	0,5	B6HVX	7435	203	BR6HIX			3419
Grac,Hobby,Huracan	50		B6HS	4510	0,5	B6HVX	7435	203	BR6HIX			3419
Micro GP,Mini 4	50		B6HS	4510	0,5	B6HVX	7435	203	BR6HIX			3419
Racing CR-7	50		B9ES	2611	0,5	B9EVX	7254	202	BR9EIX			3981
Tanga	50		BP6ES	7811	0,5	BP6EVX	5832		BPR6EIX			6637
Dragon Fly,Sky Walker	330		BP5ES	6511	0,5	BP5EVX	5470		BPR5EIX			6597
MR 326 Trial	330		BP5ES	6511	0,5	BP5EVX	5470		BPR5EIX			6597
MERLIN												
DG1,DG2/T	50		B5HS	4210	0,5							
DG7	125		BP5ES	6511	0,5	BP5EVX	5470		BPR5EIX			6597
DG3 350/Cresta/Trial/GR	350		BP5ES	6511	0,5	BP5EVX	5470		BPR5EIX			6597
DG3 350/FIUS	350		BP5ES	6511	0,5	BP5EVX	5470		BPR5EIX			6597
Nomada 500	500		D8EA	2120	0,5	D8EVX	2850	216	DR8EIX			6681
METEORIT / A . T . U												
Cruiser 125	125		DR8EA	7162	0,7	DR8EVX	6354		DR8EIX			6681
MINARELLI												
50 Cross	50				0,5	B105EGV	2171					
50 Trial	50				0,5	B95EGV	2145					
C2,E2,G1,V2,C3PK 12,7mm	50		B6HS	4510	0,5	B6HVX	7435	203	BR6HIX			3419
C2,E2,G1,V2,C3PK 19,0mm	50		B6ES	7310	0,5	B6EVX	5136					
C3KS	50		B6ES	7310	0,5	B6EVX	5136					
H3,P4E	50		B6HS	4510	0,5	B6HVX	7435	203	BR6HIX			3419
P 6 Competizione	50				0,5	B95EGV	2145					
P 6 Super	50		B8HS	5510	0,5	B8HVX	2634	205	BR8HIX			7001
P3N,P3A,P3S	50		B6HS	4510	0,5	B6HVX	7435	203	BR6HIX			3419
P4, A, P6, E	50		B6HS	4510	0,5	B6HVX	7435	203	BR6HIX			3419
P4CS, CSA, P4R	50		B7ES	1111	0,5	B7EVX	6934					
P6CS, CSA, P6R	50		B7ES	1111	0,5	B7EVX	6934					
RV4, A	50		B7ES	1111	0,5	B7EVX	6934					
V1,V1A,V1KS,VIP 12,7mm	50		B6HS	4510	0,5	B6HVX	7435	203	BR6HIX			3419
V1,V1A,V1KS,VIP 19,0mm	50		B6ES	7310	0,5	B6EVX	5136					
V1H,V1HLE,V1L	50		B6HS	4510	0,5	B6HVX	7435	203	BR6HIX			3419
W3 QM	60		B6HS	4510	0,5	B6HVX	7435	203	BR6HIX			3419
Trial	75		B9EG	3530	0,5	B9EGV	5827		BR9EIX			3981
MR 6/80	80				0,5	B11EGV	5831					
P 680	80		B6HS	4510	0,5	B6HVX	7435	203	BR6HIX			3419
125 Cross	125				0,5	B95EGV	2145					
125 Regularità	125				0,5	B95EGV	2145					
125 YPVS (Yamaha)	125		B8ES	2411	0,5	B8EVX	7051	201	BR8EIX			5044
125/5	125		B8ES	2411	0,5	B8EVX	7051	201	BR8EIX			5044
125/5 Cross	125				0,5	B10EGV	5927					
125/5 Regularità	125				0,5	B10EGV	5927					

					Order No.			Order No.			Order No.
MINSK											
MMB3-3.112	7,3kW	125		BP7HS	5111	0,7	BP7HVX	7468		BPR7HIX	5944
MMB3-3.113	7,3kW	125		BP7HS	5111	0,7	BP7HVX	7468		BPR7HIX	5944
MMB3-3.1131	7,3kW	125		BP7HS	5111	0,7	BP7HVX	7468		BPR7HIX	5944
MMB3-3.11311	7,3kW	125		BP7HS	5111	0,7	BP7HVX	7468		BPR7HIX	5944
Mototeleschka C-3.901	7,3kW	125		BP7HS	5111	0,7	BP7HVX	7468		BPR7HIX	5944
MONDIAL											
Cross Spezial		50		B7HS	5110	0,5	B7HVX	7836	204	BR7HIX	7067
Mondialino		50		B7HS	5110	0,5	B7HVX	7836	204	BR7HIX	7067
Radial		50		B8HS	5510	0,5	B8HVX	2634	205	BR8HIX	7001
Regolarita		50		B8HS	5510	0,5	B8HVX	2634	205	BR8HIX	7001
Spezial V4 Record		50		B7ES	1111	0,5	B7EVX	6934			
Touring		50		B8HS	5510	0,5	B8HVX	2634	205	BR8HIX	7001
Tourismo		50		B7HS	5110	0,5	B7HVX	7836	204	BR7HIX	7067
Cross Radial v6		125		B7HS	5110	0,5	B7HVX	7836	204	BR7HIX	7067
175 SS		175		B9HS	5810	0,5	B9HVX	2254			
Piega VTR 1000 SP		1000	03 -							FR9BI-11	4709
MONTESA											
Brio,Cirlo,Fura,Mini Cota		50		B7HS	5110	0,5	B7HVX	7836	204	BR7HIX	7067
Cota 25A/25C/49,Mini Mont.		50		B7HS	5110	0,5	B7HVX	7836	204	BR7HIX	7067
Scorpion 50R		50		B7HS	5110	0,5	B7HVX	7836	204	BR7HIX	7067
Cota 74 /74T /80		75		B7ES	1111	0,5	B7EVX	6934			
Crono 75		75		B7ES	1111	0,5	B7EVX	6934			
Enduro 75 H6 /H7/ L		75		B7ES	1111	0,5	B7EVX	6934			
Cota 123/C/T, Cota 125		123		B8ES	2411	0,5	B8EVX	7051	201	BR8EIX	5044
Cappra 125 MX		125		B8HS	5510	0,5	B8HVX	2634	205	BR8HIX	7001
Cappra 125 VA/VB/VE/VF		125		B10ES	7928	0,5	B10EVX	7335		BR10EIX	6801
Crono 125D		125		B8ES	2411	0,5	B8EVX	7051	201	BR8EIX	5044
Enduro 125 H6/H7/L		125		B8ES	2411	0,5	B8EVX	7051	201	BR8EIX	5044
Cota 172/200		175		B7ES	1111	0,5	B7EVX	6934			
Impala /2/Sport		175		B7HS	5110	0,5	B7HVX	7836	204	BR7HIX	7067
Impala 175 Comando/Turismo		175		B6HS	4510	0,5	B6HVX	7435	203	BR6HIX	3419
Kenya 175, Texas 175		175		B6HS	4510	0,5	B6HVX	7435	203	BR6HIX	3419
Cappra MX		250		B8HS	5510	0,6	B8HVX	2634	205	BR8HIX	7001
Cappra VA/B/E/F/G/R		250		B9ES	2611	0,5	B9EVX	7254	202	BR9EIX	3981
Cappra 250 /GP/MX		250		B8HS	5510	0,5	B8HVX	2634	205	BR8HIX	7001
Cappra 250 CA/VB/VE		250		B9ES	2611	0,5	B9EVX	7254	202	BR9EIX	3981
Cappra 250 VF/VG/VR		250		B9ES	2611	0,5	B9EVX	7254	202	BR9EIX	3981
Cota 242 /304 /307		250		BP7ES	2412	0,5	BP7EVX	7270	206	BPR7EIX	4055
Cota 247 /C/T		250		B8HS	5510	0,5	B8HVX	2634	205	BR8HIX	7001
Cota 248		250		BP5ES	6511	0,5	BP5EVX	5470		BPR5EIX	6597
Enduro 250 H6		250		B8ES	2411	0,5	B8EVX	7051	201	BR8EIX	5044
Enduro 250 H7		250		B10EG	3630	0,5	B10EGV	5927			
Impala		250		B8HS	5510	0,6	B8HVX	2634	205	BR8HIX	7001
Impala 250 King		250		B8HS	5510	0,5	B8HVX	2634	205	BR8HIX	7001
Impala 250 Scorpion/Sport		250		B8HS	5510	0,5	B8HVX	2634	205	BR8HIX	7001
K.Scorpion		250		B8HS	5510	0,6	B8HVX	2634	205	BR8HIX	7001
Enduro Rapita 250 Automix		250		B8ES	2411	0,5	B8EVX	7051	201	BR8EIX	5044
Cota 309		260		BPR7ES	2023	0,6	BPR7EVX	5565		BPR7EIX	4055
Cota 310/Evasion		260		BPR7ES	2023	0,6	BPR7EVX	5565		BPR7EIX	4055
Cota 311		260		BPR5ES	7422	0,6	BPR5EVX	4875		BPR5EIX	6597

					Order No.		Platin 	Order No.	Quick-No. 	Iridium 	Order No.
MONTESA											
Cota 348,Trial	310		BP5ES	6511	0,5	BP5EVX	5470			BPR5EIX	6597
315R	315	97 -	BR6ES	4922	0,8						
Cota 330,Trial	330		BP5ES	6511	0,5	BP5EVX	5470			BPR5EIX	6597
Cota 335/335E/349/349T/350	350		BP5ES	6511	0,5	BP5EVX	5470			BPR5EIX	6597
Crono 350	350		B7ES	1111	0,5	B7EVX	6934				
Enduro 360 H6/H7/H7S/L	350		B7ES	1111	0,5	B7EVX	6934				
Cappra GP,Cappra 360VA/VB	360		B8ES	2411	0,5	B8EVX	7051	201		BR8EIX	5044
Cappra 414VE/VF/VG	410		B8ES	2411	0,5	B8EVX	7051	201		BR8EIX	5044
MOTO GUZZI											
Cross 50	50		B5HS	4210	0,5						
Dingo 3M	50		B6HS	4510	0,5	B6HVX	7435	203		BR6HIX	3419
Dingo MM	50		B6HS	4510	0,5	B6HVX	7435	203		BR6HIX	3419
Furghino	50		B6HS	4510	0,5	B6HVX	7435	203		BR6HIX	3419
Magnum	50		B6ES	7310	0,5	B6EVX	5136				
Nibbio	50		B7ES	1111	0,5	B7EVX	6934				
Trotter	50	10.70 -12.73	B6HS	4510	0,5	B6HVX	7435	203		BR6HIX	3419
125 2C4T	125	10.79 -12.83	C8HSA	6821	0,5	C8HVX	2672			CR8HIX	7669
125 TT	125	07.85 -12.87	B9ES	2611	0,5	B9EVX	7254	202		BR9EIX	3981
125 Custom	125	01.86 -	B9ES	2611	0,5	B9EVX	7254	202		BR9EIX	3981
Turismo	125	01.74 -12.79	B8ES	2411	0,5	B8EVX	7051	201		BR8EIX	5044
250 FD	250	74 - 76	D8EA	2120	0,5	D8EVX	2850	216		DR8EIX	6681
250 TS	250	01.74 -07.80	B8ES	2411	0,5	B8EVX	7051	201		BR8EIX	5044
254	250	78 - 80	C8HSA	6821	0,5	C8HVX	2672			CR8HIX	7669
350 GTS	350	04.74 -07.80	D8EA	2120	0,5	D8EVX	2850	216		DR8EIX	6681
350 NTX	350	10.86 -	BP8ES	2912	0,6	BP8EVX	2671				
V 35	350	06.77 -	BP7ES	2412	0,6	BP7EVX	7270	206		BPR7EIX	4055
V 35 Florida	350	05.86 -	BP8ES	2912	0,6	BP8EVX	2671				
V 35 II	350	12.80 -01.87	B7ES	1111	0,5	B7EVX	6934				
V 35 III	350	07.85 -	BP8ES	2912	0,5	BP8EVX	2671				
V 35 Imola	350	11.79 -01.87	B7ES	1111	0,5	B7EVX	6934				
V 35 Imola II	350	79 - 86	C8HSA	6821	0,5	C8HVX	2672			CR8HIX	7669
V 35 TT	350	06.84 -12.87	BPR7ES	2023	0,5	BPR7EVX	5565			BPR7EIX	4055
V 350 Nevada	350	92 -	B8ES	2411	0,6	B8EVX	7051	201		BR8EIX	5044
400 GTS	400	05.75 -07.80	DP8EA-9	5829	0,9	DPR8EVX-9	2202			DPR8EIX-9	2202
V 40 Imola	400		BP8ES	2912	0,6	BP8EVX	2671				
Monza 500	500	01.81 -01.87	BP8ES	2912	0,6	BP8EVX	2671				
V 50	500	06.77 -	BP7ES	2412	0,6	BP7EVX	7270	206		BPR7EIX	4055
V 50 Custom	500	78 - 80	BP7ES	2412	0,6	BP7EVX	7270	206		BPR7EIX	4055
V 50 II	500	11.79 -12.81	BP7ES	2412	0,5	BP7EVX	7270	206		BPR7EIX	4055
V 50 III	500	01.81 -01.87	BP8ES	2912	0,5	BP8EVX	2671				
V 50 Monza II	500	06.84 -12.87	C8HSA	6821	0,5	C8HVX	2672			CR8HIX	7669
V 65	650	- 86	BP8ES	2912	0,6	BP8EVX	2671				
V 65	650	87 -	BCPR6ES	2330	0,5						
V 65 Florida	650	- 86	BP8ES	2912	0,6	BP8EVX	2671				
V 65 Florida	650	92 -	B8ES	2411	0,6	B8EVX	7051	201		BR8EIX	5044
V 65 Lario	650	- 86	C8HSA	6821	0,5	C8HVX	2672			CR8HIX	7669
V 65 NTX	650	90 - 92	B8ES	2411	0,6	B8EVX	7051	201		BR8EIX	5044
V 65 NTX	650	- 89	BP8ES	2912	0,6	BP8EVX	2671				
V 65 Polizia NT	650		B8ES	2411	0,6	B8EVX	7051	201		BR8EIX	5044
V 65 SP	650	- 86	BP8ES	2912	0,6	BP8EVX	2671				
V 65 TT	650	- 86	BP8ES	2912	0,6	BP8EVX	2671				



Order No.



Gold-Palladium

Platin



Order No.

Quick-No.

Iridium









Order No.









MOTO GUZZI







V7 Sport / Spezial	700		BP6ES	7811	0,5	BP6EVX	5832		BPR6EIX	6637
750 S	750	- 74	BP6ES	7811	0,5	BP6EVX	5832		BPR6EIX	6637
750 SP	750	92 -	B8ES	2411	0,6	B8EVX	7051	201	BR8EIX	5044
750 Targa	750	92 -	B8ES	2411	0,6	B8EVX	7051	201	BR8EIX	5044
Breva Naked	750	03 -	BR8ES	5422	0,6	BR8EVX	1262	207	BR8EIX	5044
Nevada Classic 750 ie	750	04 -	BR8ES	5422	0,6	BR8EVX	1262	207	BR8EIX	5044
V 75 Nevada	750	92 -	B8ES	2411	0,6	B8EVX	7051	201	BR8EIX	5044
V 75, Duna	750		C8HSA	6821	0,5	C8HVX	2672		CR8HIX	7669
V 750 NTX	750	92 -	B8ES	2411	0,6	B8EVX	7051	201	BR8EIX	5044
V 750 Polizia NT	750	92 -	B8ES	2411	0,6	B8EVX	7051	201	BR8EIX	5044
850 California	850	12.75 -12.81	BP6ES	7811	0,6	BP6EVX	5832		BPR6EIX	6637
850 Le Mans II / III	850	01.78 -12.81	BP6ES	7811	0,6	BP6EVX	5832		BPR6EIX	6637
850 T4	850	07.80 -12.83	BP6ES	7811	0,6	BP6EVX	5832		BPR6EIX	6637
850 T5	850	06.83 -12.87	BP6ES	7811	0,6	BP6EVX	5832		BPR6EIX	6637
850 TS 5	850	82 - 84	BP6ES	7811	0,6	BP6EVX	5832		BPR6EIX	6637
1000	1000		BP6ES	7811	0,6	BP6EVX	5832		BPR6EIX	6637
1000 GT	1000	88 -	BP6ES	7811	0,6	BP6EVX	5832		BPR6EIX	6637
1000 Le Mans	1000	90 -	BP7ES	2412	0,6	BP7EVX	7270	206	BPR7EIX	4055
1000 Le Mans IV	1000	01.85 - 89	BP8ES	2912	0,6	BP8EVX	2671			
1000 S	1000	89 -	BP7ES	2412	0,6	BP7EVX	7270	206	BPR7EIX	4055
1000 SP III	1000	88 - 92	BP6ES	7811	0,6	BP6EVX	5832		BPR6EIX	6637
California I.E.	1000	91 -	BP7ES	2412	0,6	BP7EVX	7270	206	BPR7EIX	4055
California III	1000	88 -	BP6ES	7811	0,6	BP6EVX	5832		BPR6EIX	6637
Daytona 1000	1000	92 -	D9EA	2420	0,6	D9EVX	2834		DR9EIX	4772
Quota 1000	1000	92 -	BP7ES	2412	0,6	BP7EVX	7270	206	BPR7EIX	4055
T 5 Polizia	1000	92 -	BP6ES	7811	0,6	BP6EVX	5832		BPR6EIX	6637
V 10 Centauro	1000	96 -	DR9EA	3437	0,7	DR9EVX	6361	219	DR9EIX	4772
California 1100 KC	1100	94 -	BPR6ES	7822	0,6	BPR6EVX	6764		BPR6EIX	6637
California 1100 KD	1100	94 -	BPR6ES	7822	0,6	BPR6EVX	6764		BPR6EIX	6637
California Aluminium	1100	03 -	BPR6ES	7822	0,6	BPR6EVX	6764		BPR6EIX	6637
California EV (KD)	1100	97 -	BPR6ES	7822	0,6	BPR6EVX	6764		BPR6EIX	6637
California Jackal (KD)	1100	99 -	BPR6ES	7822	0,6	BPR6EVX	6764		BPR6EIX	6637
California Special	1100	02 -	BPR6ES	7822	0,6	BPR6EVX	6764		BPR6EIX	6637
California Special Sport (KD) 54kW	1100	02 -	BPR6ES	7822	0,6	BPR6EVX	6764		BPR6EIX	6637
California Stone (KD) 54kW	1100		BPR6ES	7822	0,6	BPR6EVX	6764		BPR6EIX	6637
California Titanium	1100	03 -	BPR6ES	7822	0,6	BPR6EVX	6764		BPR6EIX	6637
Daytona RS (KL)	1100	96 -	DR8EA	7162	0,7	DR8EVX	6354		DR8EIX	6681
Quota 1100 (KM)	1100	06.98 -	BPR6ES	7822	0,6	BPR6EVX	6764		BPR6EIX	6637
1100 Sport (KF) (Iniezione)	1100	96 -	BPR6ES	7822	0,6	BPR6EVX	6764		BPR6EIX	6637
Sport 1100i	1100	96 -	BPR6ES	7822	0,6	BPR6EVX	6764		BPR6EIX	6637
Sport	1100	95 -	BPR6ES	7822	0,6	BPR6EVX	6764		BPR6EIX	6637
Stone Touring	1100	03 -	BPR6ES	7822	0,6	BPR6EVX	6764		BPR6EIX	6637
V 11 Naked	1100	03 -	BPR6ES	7822	0,6	BPR6EVX	6764		BPR6EIX	6637
V 11 Sport (KS)	1100	99 -	BPR6ES	7822	0,6	BPR6EVX	6764		BPR6EIX	6637
V 11 Rosso Mandello (KR)	1100	99 -	BPR6ES	7822	0,6	BPR6EVX	6764		BPR6EIX	6637
V 11 Scuro	1100	03 -	BPR6ES	7822	0,6	BPR6EVX	6764		BPR6EIX	6637
V 11 Le Mans (KS)	1100		BPR6ES	7822	0,6	BPR6EVX	6764		BPR6EIX	6637
V 11 Le Mans Nero Corsa (67kW)	1100	04 -	BPR6ES	7822	0,6	BPR6EVX	6764		BPR6EIX	6637







MOTO MORINI







350 Excalibur	350	92 -	BP7ES	2412	0,5	BP7EVX	7270	206	BPR7EIX	4055
400 Dart	400	91 -	BP8ES	2912	0,5	BP8EVX	2671			

					Order No.		Gold-Palladium	Platin 	Order No.	Quick-No.	Iridium 	Order No.
MOTO MORINI												
501 Excalibur	500	91 -	BP8ES	2912	0,5	BP8EVX	2671					
501 Excalibur	501	92 -	BP7ES	2412	0,5	BP7EVX	7270	206		BPR7EIX	4055	
MOTOR HISPANIA												
Cangurito Cross, MH	50		B6HS	4510	0,5	B6HVX	7435	203		BR6HIX	3419	
Cross/MH/MH49, Sport 49	50		B6HS	4510	0,5	B6HVX	7435	203		BR6HIX	3419	
Feria, Jabato, 50SL	50		B6ES	7310	0,5	B6EVX	5136					
Furia 4v	50		BR9ES	5722	0,8	BR9EVX	1265	208		BR9EIX	3981	
Furia 6v Cross / Super.	50		BR9ES	5722	0,8	BR9EVX	1265	208		BR9EIX	3981	
GT 81, MH 80	50		B6HS	4510	0,5	B6HVX	7435	203		BR6HIX	3419	
M 80 Automatico	50		B6ES	7310	0,5	B6EVX	5136					
Minicross	50		B7HS	5110	0,5	B7HVX	7836	204		BR7HIX	7067	
Racing RX	50		BR9ES	5722	0,8	BR9EVX	1265	208		BR9EIX	3981	
Style	50		B7HS	5110	0,5	B7HVX	7836	204		BR7HIX	7067	
MOTOR TEK												
MT 50	50	05 -	BR8HSA	5539	0,5	BR8HVX	6265			BR8HIX	7001	
MT 125 (ATV)	125	05 -	CR7HSA	4549	0,8					CR7HIX	7544	
MT 175 (ATV)	175	05 -	DR8EA	7162	0,7	DR8EVX	6354			DR8EIX	6681	
MOTO-SPEZIAL												
Bassa-Lunga	1100	99 -	BP6ES	7811	0,8	BP6EVX	5832			BPR6EIX	6637	
Sportiva 1100i	1100	99 -	BP6ES	7811	0,8	BP6EVX	5832			BPR6EIX	6637	
MOTOTECHNIKA												
Karpati	50		BP6HS	4511	0,6	BP6HVX	4635			BPR6HIX	4085	
Mokick	50		BP7HS	5111	0,7	BP7HVX	7468			BPR7HIX	5944	
Riga	50		BP6HS	4511	0,6	BP6HVX	4635			BPR6HIX	4085	
Turist	50		BP6HS	4511	0,6	BP6HVX	4635			BPR6HIX	4085	
Veachowina	50		BP6HS	4511	0,6	BP6HVX	4635			BPR6HIX	4085	
Veterok	50		BP6HS	4511	0,6	BP6HVX	4635			BPR6HIX	4085	
MTV												
50 Cross/ Sport	50		BP5ES	6511	0,5	BP5EVX	5470			BPR5EIX	6597	
MÜNCH												
Mammut 1000 TTS	1000	-12.82	BP8ES	2912	0,5	BP8EVX	2671					
4-1200 TS/TTS-E	1200	-12.82	BP8ES	2912	0,5	BP8EVX	2671					
Mammut 1200 TS	1200	-12.82	BP8ES	2912	0,5	BP8EVX	2671					
MV AGUSTA												
350 B GT/S/Scrambler	350		B8ES	2411	0,5	B8EVX	7051	201		BR8EIX	5044	
350 BE GT(216)	350		B8ES	2411	0,5	B8EVX	7051	201		BR8EIX	5044	
350 BE GT/S/Scrambler	350		B8ES	2411	0,5	B8EVX	7051	201		BR8EIX	5044	
350 BES (216)	350		B8ES	2411	0,5	B8EVX	7051	201		BR8EIX	5044	
350 Sport	350	-12.80	B8ES	2411	0,5	B8EVX	7051	201		BR8EIX	5044	
GT Electronique	350		B8ES	2411	0,5	B8EVX	7051	201		BR8EIX	5044	
S Electronique	350		B8ES	2411	0,5	B8EVX	7051	201		BR8EIX	5044	
Scrambler Electronique	350		B8ES	2411	0,5	B8EVX	7051	201		BR8EIX	5044	
199,4C6	600		B8ES	2411	0,5	B8EVX	7051	201		BR8EIX	5044	
4C75S/GT, 750GT/S/SS	750		B8ES	2411	0,5	B8EVX	7051	201		BR8EIX	5044	

					Order No.		Platin 	Order No.	Quick-No. 	Iridium 	Order No.
MV AGUSTA											
750 S American	750		B7ES	1111	0,5	B7EVX	6934				
F4 Brutale (oro) 93kW	750	99 -	CR9EKB		0,7					CR9EIX	3521
F4 Brutale S	750	02 -	CR9EKB		0,7					CR9EIX	3521
F4 Oro --> Fgst.300	750	99 -	CR9EKB		0,7					CR9EIX	3521
F4 S SPR 103KW	750	99 -	CR9EKB		0,7					CR9EIX	3521
F4 Senna 103KW	750	99 -	CR9EKB		0,7					CR9EIX	3521
800 S	800	-06.80	B8ES	2411	0,5	B8EVX	7051	201		BR8EIX	5044
900 S	900	-06.80	B8ES	2411	0,5	B8EVX	7051	201		BR8EIX	5044
MV AGUSTA											
F4 1000 Tamburini	1000	04 -	R0045J-10	7400	0,7						
F4 1000 S	1000	04 -	C9EKB		0,7						
MZ											
ATV 50	50	03 -	BP6HS	4511	0,6	BP6HVX	4635			BPR6HIX	4085
ATV 100	100	03 -	BP6HS	4511	0,6	BP6HVX	4635			BPR6HIX	4085
125 Fun X	125	01 -	CR8E	1275	0,7	CR8EVX	6487	226		CR8EIX	4218
125 Fun X	125	03 -	CR8E	1275	0,6	CR8EVX	6487	226		CR8EIX	4218
125 SM	125	01 -	CR8E	1275	0,7	CR8EVX	6487	226		CR8EIX	4218
125 SX	125	01 -	CR8E	1275	0,7	CR8EVX	6487	226		CR8EIX	4218
125 Younster Cup	125	03 -	CR8E	1275	0,6	CR8EVX	6487	226		CR8EIX	4218
RT 125	125	00 -	CR8E	1275	0,6	CR8EVX	6487	226		CR8EIX	4218
RT 125 Classic	125	03 -	CR8E	1275	0,6	CR8EVX	6487	226		CR8EIX	4218
RT 125 SM	125	00 -	CR8E	1275	0,6	CR8EVX	6487	226		CR8EIX	4218
Saxon Roadstar 7kW	125		B8HS	5510	0,6	B8HVX	2634	205		BR8HIX	7001
Saxon Sportstar 7/11kW	125		B8HS	5510	0,6	B8HVX	2634	205		BR8HIX	7001
Saxon Roadstar 9kW	150		B8HS	5510	0,6	B8HVX	2634	205		BR8HIX	7001
Saxon Sportstar 9kW	150		B8HS	5510	0,6	B8HVX	2634	205		BR8HIX	7001
ETZ Classic 13/15kW	251		B8HS	5510	0,6	B8HVX	2634	205		BR8HIX	7001
Saxon 251 Fun 13/15kW	251		B8HS	5510	0,6	B8HVX	2634	205		BR8HIX	7001
Saxon 251 Tour 13/15kW	251		B8HS	5510	0,6	B8HVX	2634	205		BR8HIX	7001
ETZ 301 Classic 17kW	301		B8HS	5510	0,6	B8HVX	2634	205		BR8HIX	7001
Saxon 301 Fun 17kW	301		B8HS	5510	0,6	B8HVX	2634	205		BR8HIX	7001
Saxon 301 Tour 17kW	301		B8HS	5510	0,6	B8HVX	2634	205		BR8HIX	7001
Saxon 500 Country 25kW	500		D8EA	2120	0,7	D8EVX	2850	216		DR8EIX	6681
Saxon 500 Fun 20/25kW	500		D8EA	2120	0,7	D8EVX	2850	216		DR8EIX	6681
Saxon 500 Funkkrad 20/25kW	500		D8EA	2120	0,7	D8EVX	2850	216		DR8EIX	6681
Saxon 500 Tour 20/25kW	500		D8EA	2120	0,7	D8EVX	2850	216		DR8EIX	6681
Saxon 500 Voyager 20/25kW	500		D8EA	2120	0,7	D8EVX	2850	216		DR8EIX	6681
Silver Star Classic 500 20kW	500		D8EA	2120	0,7	D8EVX	2850	216		DR8EIX	6681
Silver Star Classic 500 25kW	500		D8EA	2120	0,7	D8EVX	2850	216		DR8EIX	6681
Silver Star Gspann 500 25kW	500	95 -	D8EA	2120	0,7	D8EVX	2850	216		DR8EIX	6681
Baghira	660	97 -	DPR9EA-9	5329	0,9	DPR9EVX-9	3854	222		DPR9EIX-9	5545
Baghira Black Panther (4NN)	660	99 -	DPR9EA-9	5329	0,9	DPR9EVX-9	3854	222		DPR9EIX-9	5545
Baghira Black Panther HR	660	00 -	DPR9EA-9	5329	0,9	DPR9EVX-9	3854	222		DPR9EIX-9	5545
Baghira Forest	660	99 -	DPR9EA-9	5329	0,9	DPR9EVX-9	3854	222		DPR9EIX-9	5545
Baghira HR	660	99 -	DPR9EA-9	5329	0,9	DPR9EVX-9	3854	222		DPR9EIX-9	5545
Baghira Street Moto (4NN)	660	99 -	DPR9EA-9	5329	0,9	DPR9EVX-9	3854	222		DPR9EIX-9	5545
Baghira Street Moto HR	660	00 -	DPR9EA-9	5329	0,9	DPR9EVX-9	3854	222		DPR9EIX-9	5545
Mastiff	660	97 -	DPR9EA-9	5329	0,9	DPR9EVX-9	3854	222		DPR9EIX-9	5545
Replica 660	660	02.95 -	DPR9EA-9	5329	0,9	DPR9EVX-9	3854	222		DPR9EIX-9	5545
Skorpion Cup (4NN)	660	96 -	DPR9EA-9	5329	0,9	DPR9EVX-9	3854	222		DPR9EIX-9	5545

					Order No.		Platin 	Order No.	Quick-No.	Iridium 	Order No.
MZ											
Skorpion Replica	660	02.95 -	DPR9EA-9	5329	0,9	DPR9EVX-9	3854	222	DPR9EIX-9		5545
Skorpion Sport	660	94 -	DPR9EA-9	5329	0,9	DPR9EVX-9	3854	222	DPR9EIX-9		5545
Skorpion Tour	660	94 -	DPR9EA-9	5329	0,9	DPR9EVX-9	3854	222	DPR9EIX-9		5545
Skorpion Traveller	660	96 -	DPR9EA-9	5329	0,9	DPR9EVX-9	3854	222	DPR9EIX-9		5545
1000 S	1000	04 -	BCPR6ET	2197	0,8						
1000 SF	1000	05 -	BCPR6ET	2197	0,8						
MZ (TR)											
ETZ Standard OR	125	01.91 -	B8HS	5510	0,6	B8HVX	2634	205	BR8HIX		7001
ETZ Standard	125	01.91 -	B8HS	5510	0,6	B8HVX	2634	205	BR8HIX		7001
Saxon Tour 251	125	01.91 -	B8HS	5510	0,6	B8HVX	2634	205	BR8HIX		7001
TS 125	125	01.75 -12.85	B8HS	5510	0,6	B8HVX	2634	205	BR8HIX		7001
ETZ 150	150	01.84 -12.90	B8HS	5510	0,6	B8HVX	2634	205	BR8HIX		7001
TS 150	150	01.75 -12.85	B8HS	5510	0,6	B8HVX	2634	205	BR8HIX		7001
TS 250	250	01.75 -12.85	B8HS	5510	0,6	B8HVX	2634	205	BR8HIX		7001
NORTON											
Atlas			BP8ES	2912	0,6	BP8EVX	2671				
Commander			C8E	7471	0,6	CR8EVX	6487		CR8EIX		4218
Commando			BP7ES	2412	0,6	BP7EVX	7270	206	BPR7EIX		4055
F 1			C8E	7471	0,6	CR8EVX	6487		CR8EIX		4218
C 652 SM engine F650	650	99 -	D8EA	2120	0,6	D8EVX	2850	216	DR8EIX		6681
NSU											
Supermax	250	56 -	B8HS	5510	0,5	B8HVX	2634	205	BR8HIX		7001
OMER											
Cross Mini	50		B6HS	4510	0,6	B6HVX	7435	203	BR6HIX		3419
Daytona 8 Mini	50		B6HS	4510	0,6	B6HVX	7435	203	BR6HIX		3419
Maggiolino	50		B5HS	4210	0,5						
Maggiolione	50		B5HS	4210	0,5						
Tanga / Noleggiato	50		B6HS	4510	0,6	B6HVX	7435	203	BR6HIX		3419
Valllelunga 10	50		B6HS	4510	0,6	B6HVX	7435	203	BR6HIX		3419
Vivo	50		BP6ES	7811	0,6	BP6EVX	5832		BPR6EIX		6637
OSSA											
Ossita 50	50		B5HS	4210	0,5						
125 Enduro/Super Pioneer	125		B8ES	2411	0,5	B8EVX	7051	201	BR8EIX		5044
125 Moto Cross/Phantom	125		B9ES	2611	0,5	B9EVX	7254	202	BR9EIX		3981
150 Phantom	150		B8ES	2411	0,5	B8EVX	7051	201	BR8EIX		5044
160 GT-T2	160		B7ES	1111	0,5	B7EVX	6934				
175 American/Enduro/Sport	175		B8ES	2411	0,5	B8EVX	7051	201	BR8EIX		5044
175 Moto Cross/Phantom	175		B9ES	2611	0,5	B9EVX	7254	202	BR9EIX		3981
175 Super Pioneer/ 6 Dias	175		B8ES	2411	0,5	B8EVX	7051	201	BR8EIX		5044
230 Explorer/Trial	230		BP5ES	6511	0,5	BP5EVX	5470		BPR5EIX		6597
230 Super Pioneer	230		B8ES	2411	0,5	B8EVX	7051	201	BR8EIX		5044
250 American Enduro/Copa	250		B9ES	2611	0,5	B9EVX	7254	202	BR9EIX		3981
Copa F3	250				0,5	B9EVX	7254		BR9EIX		3981
Desert, Phantom, S.Pioneer	250		B9ES	2611	0,5	B9EVX	7254	202	BR9EIX		3981
Desert/Enduro/Moto Cross	250		B9ES	2611	0,5	B9EVX	7254	202	BR9EIX		3981
M.A.R. Explorer / Trial	250		BP5ES	6511	0,5	BP5EVX	5470		BPR5EIX		6597
Sport/Super Pioneer,TE 250	250		B9ES	2611	0,5	B9EVX	7254	202	BR9EIX		3981

				Order No.		Platin 	Order No.	Quick-No.	Iridium 	Order No.
OSSA										
T, Copa F3	250		B9ES	2611	0,5	B9EVX	7254	202	BR9EIX	3981
TR 80,250 Exp./Trial/Tu-yo	250		BP5ES	6511	0,5	BP5EVX	5470		BPR5EIX	6597
Urbe Phanton,Trofeo 250 E7	250		B9ES	2611	0,5	B9EVX	7254	202	BR9EIX	3981
303 Trial,TR 80,	350		BP5ES	6511	0,5	BP5EVX	5470		BPR5EIX	6597
350 Desert/Super Pioneer	350		B8ES	2411	0,5	B8EVX	7051	201	BR8EIX	5044
350 Explorer/Tu-yo , Trail	350		BP5ES	6511	0,5	BP5EVX	5470		BPR5EIX	6597
500 S, Yankee	500		B8ES	2411	0,5	B8EVX	7051	201	BR8EIX	5044
PANDA										
KD 50 A (ATV)	50	00 -	CR6HSA	2983	0,7				CR6HIX	7274
KD 80 A (ATV)	80	00 -	CR6HSA	2983	0,7				CR6HIX	7274
KD 125 A (ATV)	125	00 -	CR6HSA	2983	0,7				CR6HIX	7274
PEUGEOT										
101	50	04.75 -	B5HS	4210	0,5					
102	50	04.75 -	B5HS	4210	0,5					
103	50	04.75 -	B5HS	4210	0,5					
103 CRX	50		B8HS	5510	0,5	B8HVX	2634	205	BR8HIX	7001
103 LC	50		B8ES	2411	0,5	B8EVX	7051	201	BR8EIX	5044
103 LSM-D	50	06.82 -	B6HS	4510	0,5	B6HVX	7435	203	BR6HIX	3419
103 MP/MR	50		B8HS	5510	0,5	B8HVX	2634	205	BR8HIX	7001
103 Racen	50		B8HS	5510	0,5	B8HVX	2634	205	BR8HIX	7001
103 SP	50	86 -	B8HS	5510	0,5	B8HVX	2634	205	BR8HIX	7001
103 SPM-D	50	04.75 -	B6HS	4510	0,5	B6HVX	7435	203	BR6HIX	3419
103 T16	50		B8HS	5510	0,5	B8HVX	2634	205	BR8HIX	7001
103 TXLC,TXR	50		B8ES	2411	0,5	B8EVX	7051	201	BR8EIX	5044
103 Vogue	50		B8HS	5510	0,5	B8HVX	2634	205	BR8HIX	7001
103 XP,XPLC	50	01.86 -	B8ES	2411	0,5	B8EVX	7051	201	BR8EIX	5044
104	50		B5HS	4210	0,5					
105	50		B5HS	4210	0,5					
BB3K	50		B6HS	4510	0,5	B6HVX	7435	203	BR6HIX	3419
BB3L	50		B6HS	4510	0,5	B6HVX	7435	203	BR6HIX	3419
BB3SP	50		B6HS	4510	0,5	B6HVX	7435	203	BR6HIX	3419
C 50	50		B5HS	4210	0,5					
GL 10	50	01.79 -	B6HS	4510	0,5	B6HVX	7435	203	BR6HIX	3419
GT 10	50		B6HS	4510	0,5	B6HVX	7435	203	BR6HIX	3419
P 80	50		B8HS	5510	0,5	B8HVX	2634	205	BR8HIX	7001
RS	50		B5HS	4210	0,5					
RT	50		B5HS	4210	0,5					
S 157	50		B5HS	4210	0,5					
S 55	50		B5HS	4210	0,5					
SC 50	50		B6HS	4510	0,5	B6HVX	7435	203	BR6HIX	3419
SC 50 L (I)	50		BPR6HS	7022	0,6	BPR6HVX	2740	214	BPR6HIX	4085
SC 50L	50		B6HS	4510	0,5	B6HVX	7435	203	BR6HIX	3419
Scoper V50	50		B6HS	4510	0,5	B6HVX	7435	203	BR6HIX	3419
ST, STL 2, Rapido	50		BR6HSA	4296	0,6			210	BR6HIX	3419
SX5	50		B5HS	4210	0,5					
TLX 50	50		B6HS	4510	0,5	B6HVX	7435	203	BR6HIX	3419
TSA	50		B6HS	4510	0,5	B6HVX	7435	203	BR6HIX	3419
Velo a moteur Count.	50		B8HS	5510	0,5	B8HVX	2634	205	BR8HIX	7001
X 125 LC	50		B10ES	7928	0,5	B10EVX	7335		BR10EIX	6801
SC80L	80	06.82 -	BPR6HS	7022	0,7	BPR6HVX	2740	214	BPR6HIX	4085

				Order No.		Platin 	Order No.	Quick-No.	Iridium 	Order No.
PEUGEOT										
SX8T	80	02.78 -12.82	B7HS	5110	0,5	B7HVX	7836	204	BR7HIX	7067
P51-53	100		B6S	3510	0,5					
55 C	125		B6HS	4510	0,5	B6HVX	7435	203	BR6HIX	3419
55 D	125		B6HS	4510	0,5	B6HVX	7435	203	BR6HIX	3419
550	125		B6HS	4510	0,5	B6HVX	7435	203	BR6HIX	3419
P 150	150		B6HS	4510	0,5	B6HVX	7435	203	BR6HIX	3419
P 155	155		B6HS	4510	0,5	B6HVX	7435	203	BR6HIX	3419
P 156	155		B6HS	4510	0,5	B6HVX	7435	203	BR6HIX	3419
176	175		B6HS	4510	0,5	B6HVX	7435	203	BR6HIX	3419
176 BB	175		B6HS	4510	0,5	B6HVX	7435	203	BR6HIX	3419
176 Grand Sport	175		B8ES	2411	0,5	B8EVX	7051	201	BR8EIX	5044
176 TC	175		B6HS	4510	0,5	B6HVX	7435	203	BR6HIX	3419
256	250		B7HS	5110	0,5	B7HVX	7836	204	BR7HIX	7067
PIAGGIO										
--> Scooter/Roller										
POLARIS										
Big Boss (ATV)	244	89 - 93	BR8ES	5422	0,6	BR8EVX	1262	207	BR8EIX	5044
Cyclone (ATV)	244	88 - 89	BR8ES	5422	0,6	BR8EVX	1262	207	BR8EIX	5044
Scrambler (ATV)	244	89 - 93	BR8ES	5422	0,6	BR8EVX	1262	207	BR8EIX	5044
Trail Blazer (ATV)	244	90 -	BR8ES	5422	0,6	BR8EVX	1262	207	BR8EIX	5044
Trail Boss (ATV)	244	85 -	BR8ES	5422	0,6	BR8EVX	1262	207	BR8EIX	5044
Xplorer 300 (ATV)	283	94 -	BR8ES	5422	0,6	BR8EVX	1262	207	BR8EIX	5044
Xpress 300 (ATV)	283	94 -	BR8ES	5422	0,6	BR8EVX	1262	207	BR8EIX	5044
Sportsman 335 (ATV)	334	99 -	BKR7E	6097	0,6				BKR7EIX	2667
Big Boss (ATV)	350	93 -	BR8ES	5422	0,6	BR8EVX	1262	207	BR8EIX	5044
Trail Boss (ATV)	350	90 - 93	BR8ES	5422	0,6	BR8EVX	1262	207	BR8EIX	5044
Big Boss 400L (6X6) (ATV)	379	95 - 97	BR8ES	5422	0,6	BR8EVX	1262	207	BR8EIX	5044
Scambler 400 (4X4) (ATV)	379	94 -	BR8ES	5422	0,6	BR8EVX	1262	207	BR8EIX	5044
Sport 400 (ATV)	379	98 -	BR8ES	5422	0,6	BR8EVX	1262	207	BR8EIX	5044
Sport ATV (ATV)	379	95 - 97	BR8ES	5422	0,6	BR8EVX	1262	207	BR8EIX	5044
Sportsman 4x4 (ATV)	379	94 - 97	BR8ES	5422	0,6	BR8EVX	1262	207	BR8EIX	5044
Xplorer 400/400L 4x4 (ATV)	379	94 -	BR8ES	5422	0,6	BR8EVX	1262	207	BR8EIX	5044
Xpress 400 L 2x4 (ATV)	379	96 - 97	BR8ES	5422	0,6	BR8EVX	1262	207	BR8EIX	5044
Magnum (2X4) (ATV)	425	95 -	BKR5E	7938	0,6				BKR5EIX	6341
Magnum (4X4) (ATV)	425	95 -	BKR5E	7938	0,6				BKR5EIX	6341
Magnum (6X6) (ATV)	425	96 - 97	BKR5E	7938	0,6				BKR5EIX	6341
Big Boss 500 (6X6) (ATV)	500	98 -	BKR5E	7938	0,6				BKR5EIX	6341
Magnum 500 (ATV)	500	99 -	BKR5E	7938	0,6				BKR5EIX	6341
Ranger (ATV)	500	99 -	BKR5E	7938	0,6				BKR5EIX	6341
Scrambler 500 (ATV)	500	98 -	BKR5E	7938	0,6				BKR5EIX	6341
Sportsman 500 (ATV)	500	96 -	BKR5E	7938	0,6				BKR5EIX	6341
Xplorer 500 (ATV)	500	97 -	BKR5E	7938	0,6				BKR5EIX	6341
Sportsmann 600 (ATV)	600	03 -	BKR7E	6097	0,6				BKR7EIX	2667
Sportsmann 700 (ATV)	700	03 -	BKR7E	6097	0,6				BKR7EIX	2667
POLINI										
Steel 910	50		B6HS	4510	0,6	B6HVX	7435	203	BR6HIX	3419
Steel 910 LC	50		B6HS	4510	0,6	B6HVX	7435	203	BR6HIX	3419
Steel 910 LC Race	50				0,6	B7HVX	7836		BR7HIX	7067
Steel 910 Race	50				0,6	B7HVX	7836		BR7HIX	7067



Order No.



Gold-Palladium

Platin



Order No.

Quick-No.







Iridium









Order No.

PUCH

DS 50	50		B6HS	4510	0,5	B6HVX	7435	203	BR6HIX	3419
DS 50 K	50		B6HS	4510	0,5	B6HVX	7435	203	BR6HIX	3419
DS 50 KXN	50		B6HS	4510	0,5	B6HVX	7435	203	BR6HIX	3419
DS 50 RN	50		B6HS	4510	0,5	B6HVX	7435	203	BR6HIX	3419
DS 60 C	50		B6HS	4510	0,5	B6HVX	7435	203	BR6HIX	3419
DS 60 CN	50		B6HS	4510	0,5	B6HVX	7435	203	BR6HIX	3419
DS 60 R	50		B6HS	4510	0,5	B6HVX	7435	203	BR6HIX	3419
DS 60 RN	50		B6HS	4510	0,5	B6HVX	7435	203	BR6HIX	3419
GS 50	50		B9HCS	2721	0,5					
GT 50	50		B9HS	5810	0,5	B9HVX	2254			
GTL 50	50		B9HS	5810	0,5	B9HVX	2254			
M 50 Jet	50		B8HS	5510	0,5	B8HVX	2634	205	BR8HIX	7001
M 50 Racing	50		B6HS	4510	0,5	B6HVX	7435	203	BR6HIX	3419
M 50 SE	50		B6HS	4510	0,5	B6HVX	7435	203	BR6HIX	3419
Maxi	50		B4H	4110	0,5					
Maxi 2 Gang	50		B5HS	4210	0,5					
Maxi II	50		B5HS	4210	0,5					
Maxi II-25	50		B4H	4110	0,5					
Maxi N	50		B5HS	4210	0,5					
Maxi S	50		B4H	4110	0,5					
MC 60 Scrambler	50		B8HS	5510	0,5	B8HVX	2634	205	BR8HIX	7001
MS 25	50		B6HS	4510	0,5	B6HVX	7435	203	BR6HIX	3419
MS 50 De Luxe Sears	50		B6HS	4510	0,5	B6HVX	7435	203	BR6HIX	3419
MS 50 Standard Sears	50		B6HS	4510	0,5	B6HVX	7435	203	BR6HIX	3419
MS 50 STD. California	50		B6HS	4510	0,5	B6HVX	7435	203	BR6HIX	3419
MS 50 V	50		B6HS	4510	0,5	B6HVX	7435	203	BR6HIX	3419
MS 50 V-Autolec	50		B6HS	4510	0,5	B6HVX	7435	203	BR6HIX	3419
P 1 L	50		B4H	4110	0,5					
P 1 XL	50		B4H	4110	0,5					
R 50	50		B6HS	4510	0,5	B6HVX	7435	203	BR6HIX	3419
R 50 K	50		B6HS	4510	0,5	B6HVX	7435	203	BR6HIX	3419
R 50 M	50		B8HS	5510	0,5	B8HVX	2634	205	BR8HIX	7001
R 50 V	50		B6HS	4510	0,5	B6HVX	7435	203	BR6HIX	3419
R 60 R	50		B6HS	4510	0,5	B6HVX	7435	203	BR6HIX	3419
VS 50 D	50		B6HS	4510	0,5	B6HVX	7435	203	BR6HIX	3419
VS 50 DK	50		B6HS	4510	0,5	B6HVX	7435	203	BR6HIX	3419
VS 50 DS	50		B6HS	4510	0,5	B6HVX	7435	203	BR6HIX	3419
VS 50 L	50		B6HS	4510	0,5	B6HVX	7435	203	BR6HIX	3419
VS 50 L-Autolec	50		B6HS	4510	0,5	B6HVX	7435	203	BR6HIX	3419
VS 60 R	50		B6HS	4510	0,5	B6HVX	7435	203	BR6HIX	3419
VZ 50 K	50		B6HS	4510	0,5	B6HVX	7435	203	BR6HIX	3419
VZ 50 M	50		B8HS	5510	0,5	B8HVX	2634	205	BR8HIX	7001
VZ 50 R	50		B6HS	4510	0,5	B6HVX	7435	203	BR6HIX	3419
VZ 50 V	50		B6HS	4510	0,5	B6HVX	7435	203	BR6HIX	3419
VZ 60 R	50		B6HS	4510	0,5	B6HVX	7435	203	BR6HIX	3419
X 30	50		B6HS	4510	0,5	B6HVX	7435	203	BR6HIX	3419
X 50-3	50		B7HS	5110	0,5	B7HVX	7836	204	BR7HIX	7067
Cobra 12,9 mm	80	81 -	B9HS	5810	0,5	B9HVX	2254			
Cobra 19,0 mm	80	81 -	B9ES	2611	0,5	B9EVX	7254	202	BR9EIX	3981
MC 125	125		B9ES	2611	0,5	B9EVX	7254	202	BR9EIX	3981
MC 175	175		B8ES	2411	0,5	B8EVX	7051	201	BR8EIX	5044
GS 250	250		B8ES	2411	0,5	B8EVX	7051	201	BR8EIX	5044

					Order No.		Gold-Palladium	Platin 	Order No.	Quick-No.	Iridium 	Order No.
PUCH												
MC 250	250		B9ES	2611	0,5	B9EVX	7254	202	BR9EIX		3981	
GS 350	350		B10EG	3630	0,6	B10EGV	5927					
GS 366	366		B8ES	2411	0,5	B8EVX	7051	201	BR8EIX		5044	
GS 500	500		DP9EA-9	6629	0,9	DP9EVX-9	3331		DPR9EIX-9		5545	
MC 500	500				0,6	B10EGV	5927					
GS 560	560		DP9EA-9	6629	0,9	DP9EVX-9	3331		DPR9EIX-9		5545	
REGENT												
Roadster,Tourer,RT 125	125		B7HS	5110	0,6	B7HVX	7836	204	BR7HIX		7067	
Roadster,Tourer,RT 150	150		B7HS	5110	0,6	B7HVX	7836	204	BR7HIX		7067	
Roadster,Tourer,RT 175	175		B7HS	5110	0,6	B7HVX	7836	204	BR7HIX		7067	
REX												
Chopper 125	125		DR8EA	7162	0,7	DR8EVX	6354		DR8EIX		6681	
Cruiser 125	125		DR8EA	7162	0,7	DR8EVX	6354		DR8EIX		6681	
Fun Bike	125	00 -	DP7EA-9	5629	0,9	DPR7EVX-9	7682		DPR7EIX-9		7803	
RIEJU												
Confort 402/403,Pony 50	50		B5HS	4210	0,5							
Confort 501,Helios,Varimat	50		B5HS	4210	0,5							
Drac 50(Air),Marathon 50	50		B6ES	7310	0,5	B6EVX	5136					
Drac(Water),RS-1,RV 50	50		B7ES	1111	0,5	B7EVX	6934					
MRX 50	50	03 -	BR8ES	5422	0,7	BR8EVX	1262	207	BR8EIX		5044	
MX 50 (Child's)	50		B6HS	4510	0,5	B6HVX	7435	203	BR6HIX		3419	
NKD 50 RS 2 Naked	50	03 -	BR8ES	5422	0,7	BR8EVX	1262	207	BR8EIX		5044	
RR 50 AM6	50		BR8ES	5422	0,7	BR8EVX	1262	207	BR8EIX		5044	
RR 50 Spezial Edition	50	03 -	BR8ES	5422	0,7	BR8EVX	1262	207	BR8EIX		5044	
RS 2	50	03 -	BR8ES	5422	0,7	BR8EVX	1262	207	BR8EIX		5044	
RS 1	50		BR8ES	5422	0,7	BR8EVX	1262	207	BR8EIX		5044	
SMX 50	50	03 -	BR8ES	5422	0,7	BR8EVX	1262	207	BR8EIX		5044	
Spike 50	50	03 -	BR8ES	5422	0,7	BR8EVX	1262	207	BR8EIX		5044	
Sprint,Autom.Kick Starter	50		B5HS	4210	0,5							
Strada GT 49/GT Sport	50		B6ES	7310	0,5	B6EVX	5136					
Super Marathon 50/FDN/MT	50		B6ES	7310	0,5	B6EVX	5136					
Marathon 74 TT/Enduro	75		B6ES	7310	0,5	B6EVX	5136					
Marathon 75 Cross(Competi)	75				0,5	B10EGV	5927					
Marathon 75 Enduro	75				0,5	B10EGV	5927					
MR 74E,MR 75E,Strada GT75	75		B6ES	7310	0,5	B6EVX	5136					
TT 406	75		B6HS	4510	0,5	B6HVX	7435	203	BR6HIX		3419	
MR 80 Enduro/Cross(Compet)	80				0,5	B10EGV	5927					
MR 80E, RST-80	80		B6ES	7310	0,5	B6EVX	5136					
MRX 125	125	03 -	BR8ES	5422	0,8	BR8EVX	1262	207	BR8EIX		5044	
SMX 125	125	03 -	BR8ES	5422	0,8	BR8EVX	1262	207	BR8EIX		5044	
RIERA												
Windy	50		BR7HS	4122	0,5				211	BR7HIX		7067
RIXE												
Champion FT / FTH	50		B6HS	4510	0,6	B6HVX	7435	203	BR6HIX		3419	
Derby B	50		B7HS	5110	0,5	B7HVX	7836	204	BR7HIX		7067	
Derby D	50		B8HS	5510	0,5	B8HVX	2634	205	BR8HIX		7001	
Geschäftsmoped	50		B7HS	5110	0,5	B7HVX	7836	204	BR7HIX		7067	

				Order No.		Platin 	Order No.	Quick-No. 	Iridium 	Order No.
RIXE										
Hight Sport	50		B6HS	4510	0,6	B6HVX	7435	203	BR6HIX	3419
Libelle E21	50		B4H	4110	0,5					
Libelle E23	50		B4H	4110	0,5					
Libelle FT/FTH/GTH	50		B6HS	4510	0,6	B6HVX	7435	203	BR6HIX	3419
Libelle Hight Sport Super	50		B4H	4110	0,5					
R503	50		B6HS	4510	0,6	B6HVX	7435	203	BR6HIX	3419
R504	50		B7HS	5110	0,5	B7HVX	7836	204	BR7HIX	7067
RS50 B3/ B4	50		B6HS	4510	0,6	B6HVX	7435	203	BR6HIX	3419
RS50S	50		B8HS	5510	0,5	B8HVX	2634	205	BR8HIX	7001
Standard 7 h	50		B7HS	5110	0,5	B7HVX	7836	204	BR7HIX	7067
Turismo 4	50		B7HS	5110	0,5	B7HVX	7836	204	BR7HIX	7067
Turismo E21	50		B6HS	4510	0,6	B6HVX	7435	203	BR6HIX	3419
Turismo ELS	50		B6HS	4510	0,6	B6HVX	7435	203	BR6HIX	3419
Turismo SL40	50		B6HS	4510	0,6	B6HVX	7435	203	BR6HIX	3419
RIZZATO										
Califfo K	50		B5HS	4210	0,5					
Califfo 121 matic	50		B6HS	4510	0,6	B6HVX	7435	203	BR6HIX	3419
Califfo 80	50		B5HS	4210	0,5					
Califfo engine 119	50		B5HS	4210	0,5					
Califfo Mini	50		B5HS	4210	0,5					
Califfo Monomarcia Super	50		B6HS	4510	0,6	B6HVX	7435	203	BR6HIX	3419
Califfone 4 M	50		B5HS	4210	0,5					
Cross Satan 71	50		B6HS	4510	0,6	B6HVX	7435	203	BR6HIX	3419
Gio	50		B5HS	4210	0,5					
Mirage P4 Daytona	50		B6HS	4510	0,6	B6HVX	7435	203	BR6HIX	3419
Piu	50		B5HS	4210	0,5					
Ringo	50		B6HS	4510	0,6	B6HVX	7435	203	BR6HIX	3419
Satan	50		B6HS	4510	0,6	B6HVX	7435	203	BR6HIX	3419
Super Luxe 73	50		B6HS	4510	0,6	B6HVX	7435	203	BR6HIX	3419
Super Sprint Mirage	50		B6HS	4510	0,6	B6HVX	7435	203	BR6HIX	3419
Turismo Monomarcia	50		B6HS	4510	0,6	B6HVX	7435	203	BR6HIX	3419
Zum 3	50		B6HS	4510	0,6	B6HVX	7435	203	BR6HIX	3419
Cross Coguaro	125		B8ES	2411	0,5	B8EVX	7051	201	BR8EIX	5044
Tourismo	125		B8ES	2411	0,5	B8EVX	7051	201	BR8EIX	5044
S.I.S.										
4 Cyclone	50		B8HS	5510	0,5	B8HVX	2634	205	BR8HIX	7001
Almirante 4/5	50		B8HS	5510	0,5	B8HVX	2634	205	BR8HIX	7001
Asa d'Ouro	50		B6HS	4510	0,6	B6HVX	7435	203	BR6HIX	3419
Brass	50		B6HS	4510	0,6	B6HVX	7435	203	BR6HIX	3419
EKO 70	50		B7HS	5110	0,5	B7HVX	7836	204	BR7HIX	7067
Felino	50		B7HS	5110	0,5	B7HVX	7836	204	BR7HIX	7067
Lebre / V4	50		B8HS	5510	0,5	B8HVX	2634	205	BR8HIX	7001
Mini Sport	50		B7HS	5110	0,5	B7HVX	7836	204	BR7HIX	7067
Mini Turismo	50		B7HS	5110	0,5	B7HVX	7836	204	BR7HIX	7067
Minor GT	50		B6HS	4510	0,6	B6HVX	7435	203	BR6HIX	3419
V5 Sport	50		B8HS	5510	0,5	B8HVX	2634	205	BR8HIX	7001
V5 Super Sport	50		B8HS	5510	0,5	B8HVX	2634	205	BR8HIX	7001
V5 Turismo	50		B8HS	5510	0,5	B8HVX	2634	205	BR8HIX	7001



Order No.



Gold-Palladium



Order No.

Quick-No.

















Iridium







Order No.







SACHS

Saxonette Classic	30		BP4	2911	0,5								
Saxonette	30	01.87 -	BPR4S	4427	0,5								
City Bike C1	50	10.72 -08.78	B6HS	4510	0,7	B6HVX	7435	203	BR6HIX			3419	
City Bike C2	50	10.72 -08.78	B6HS	4510	0,7	B6HVX	7435	203	BR6HIX			3419	
City Bike C3	50	09.74 -08.78	B6HS	4510	0,7	B6HVX	7435	203	BR6HIX			3419	
Dirty Devil 50	50		BP5HS	4111	0,5								
Enduro ZX 50	50		BR8ES	5422	0,5	BR8EVX	1262	207	BR8EIX			5044	
Hobby Rider HR 1	50	10.72 -12.87	B6HS	4510	0,7	B6HVX	7435	203	BR6HIX			3419	
Hobby Rider HR 2	50	10.72 -12.87	B6HS	4510	0,7	B6HVX	7435	203	BR6HIX			3419	
Jogging	50		B6HS	4510	0,5	B6HVX	7435	203	BR6HIX			3419	
K 50	50	-08.78	B8HS	5510	0,7	B8HVX	2634	205	BR8HIX			7001	
K 50 Ultra	50	-08.78	B8HS	5510	0,7	B8HVX	2634	205	BR8HIX			7001	
K 50 Ultra II	50	-08.78	B8HS	5510	0,5	B8HVX	2634	205	BR8HIX			7001	
K 50 Ultra LC	50	-08.78	B9ES	2611	0,5	B9EVX	7254	202	BR9EIX			3981	
K 50 Ultra LC II	50	-08.78	B9ES	2611	0,5	B9EVX	7254	202	BR9EIX			3981	
K 50 Ultra LC III	50	-08.78	B9ES	2611	0,5	B9EVX	7254	202	BR9EIX			3981	
KX 5	50	01.86 -	BP7HS	5111	0,5	BP7HVX	7468		BPR7HIX			5944	
KX 50	50		B6HS	4510	0,5	B6HVX	7435	203	BR6HIX			3419	
Lastboy	50		B7HS	5110	0,5	B7HVX	7836	204	BR7HIX			7067	
M1	50	10.72 -12.77	B6HS	4510	0,5	B6HVX	7435	203	BR6HIX			3419	
M2	50	10.72 -12.77	B6HS	4510	0,5	B6HVX	7435	203	BR6HIX			3419	
M4	50	09.74 -12.78	B6HS	4510	0,5	B6HVX	7435	203	BR6HIX			3419	
M5	50	09.74 -12.78	B6HS	4510	0,5	B6HVX	7435	203	BR6HIX			3419	
MK 1S	50	01.78 -08.80	B6HS	4510	0,5	B6HVX	7435	203	BR6HIX			3419	
MK 2S	50	01.78 -08.80	B6HS	4510	0,5	B6HVX	7435	203	BR6HIX			3419	
MP 2	50	10.72 -12.77	B6HS	4510	0,5	B6HVX	7435	203	BR6HIX			3419	
MP 4	50	10.72 -12.77	B6HS	4510	0,5	B6HVX	7435	203	BR6HIX			3419	
MX 1	50		B6HS	4510	0,5	B6HVX	7435	203	BR6HIX			3419	
MX 1	50	01.89 -	B5HS	4210	0,5								
Optima 3	50	01.78 -	B6HS	4510	0,5	B6HVX	7435	203	BR6HIX			3419	
Optima 50	50		BR8HS	4322	0,5	BR8HVX	6265	212	BR8HIX			7001	
Prima 2	50		BR5HS	3722	0,5								
Prima 2S	50	01.89 -	B5HS	4210	0,5								
Prima 3	50		B6HS	4510	0,5	B6HVX	7435	203	BR6HIX			3419	
Prima 3S	50	01.89 -	B5HS	4210	0,5								
Prima 4	50		B6HS	4510	0,5	B6HVX	7435	203	BR6HIX			3419	
Prima 4LN,5LN	50		B6HS	4510	0,5	B6HVX	7435	203	BR6HIX			3419	
Prima 5	50		B6HS	4510	0,5	B6HVX	7435	203	BR6HIX			3419	
Prima 5,5S	50	01.89 -	BR5HS	3722	0,5								
Prima 6	50		B6HS	4510	0,5	B6HVX	7435	203	BR6HIX			3419	
Prima G3	50		B6HS	4510	0,5	B6HVX	7435	203	BR6HIX			3419	
Prima GT	50	01.89 -	B5HS	4210	0,5								
Prima GT,GX	50		B6HS	4510	0,5	B6HVX	7435	203	BR6HIX			3419	
Prima Presto	50		B6HS	4510	0,5	B6HVX	7435	203	BR6HIX			3419	
Prima Pronto	50		B6HS	4510	0,5	B6HVX	7435	203	BR6HIX			3419	
Prima S	50		B6HS	4510	0,5	B6HVX	7435	203	BR6HIX			3419	
Prima SL	50		B6HS	4510	0,5	B6HVX	7435	203	BR6HIX			3419	
Prima SX	50		B6HS	4510	0,5	B6HVX	7435	203	BR6HIX			3419	
Sport Bike SB1	50	10.72 -08.74	B8HS	5510	0,5	B8HVX	2634	205	BR8HIX			7001	
Sport Bike SB2	50	10.72 -08.79	B6HS	4510	0,5	B6HVX	7435	203	BR6HIX			3419	
Sport Bike SB3	50	09.74 -08.79	B6HS	4510	0,5	B6HVX	7435	203	BR6HIX			3419	
Sport Bike SB5	50	09.74 -08.76	B8HS	5510	0,5	B8HVX	2634	205	BR8HIX			7001	

				Order No.		Platin 	Order No.	Quick-No. 	Iridium 	Order No.
SACHS										
Supra 2D,3D	50	06.80 -	B6HS	4510	0,5	B6HVX	7435	203	BR6HIX	3419
Supra 4	50	06.78 -	B7HS	5110	0,5	B7HVX	7836	204	BR7HIX	7067
Supra 4GP	50	01.80 -	B6HS	4510	0,5	B6HVX	7435	203	BR6HIX	3419
Supra Enduro	50	03.80 -	B6HS	4510	0,5	B6HVX	7435	203	BR6HIX	3419
Ultra 50	50		B9ES	2611	0,5	B9EVX	7254	202	BR9EIX	3981
XE 5	50	01.86 -	BP7HS	5111	0,5	BP7HVX	7468		BPR7HIX	5944
ZX 1	50		B7ES	1111	0,5	B7EVX	6934			
RX 9	80		B8HS	5510	0,5	B8HVX	2634	205	BR8HIX	7001
Ultra 80 LC	80		B8HS	5510	0,5	B8HVX	2634	205	BR8HIX	7001
Ultra 80 AC	80	01.82 -	B7HS	5110	0,5	B7HVX	7836	204	BR7HIX	7067
XE 9	80	01.82 -	B8HS	5510	0,5	B8HVX	2634	205	BR8HIX	7001
K 100 X	100		B8HS	5510	0,5	B8HVX	2634	205	BR8HIX	7001
Dirty Devil 110	110		C7HSA	4629	0,6	C7HVX	4533		CR7HIX	7544
K 125 BW Military	125	09.74 -	B8HS	5510	0,5	B8HVX	2634	205	BR8HIX	7001
K 125 GS	125		B9ES	2611	0,5	B9EVX	7254	202	BR9EIX	3981
K 125 MC	125		B9ES	2611	0,5	B9EVX	7254	202	BR9EIX	3981
K 125 S	125	10.72 -08.79			0,5	B9EVX	7254		BR9EIX	3981
K 125 T	125	10.72 -08.79			0,5	B9EVX	7254		BR9EIX	3981
K 125 X	125		B8HS	5510	0,5	B8HVX	2634	205	BR8HIX	7001
Roadster 125 V2	125	98 -	CR6HSA	2983	0,8				CR6HIX	7274
RS 125	125	97 -	BR8ES	5422	0,7	BR8EVX	1262	207	BR8EIX	5044
XTC 125 V2 11kW	125	98 -	BR9ES	5722	0,8	BR9EVX	1265	208	BR9EIX	3981
XTC-N 125 V2 7,8kW	125	98 -	BR8ES	5422	0,8	BR8EVX	1262	207	BR8EIX	5044
ZX 125	125	97 -	BR8ES	5422	0,7	BR8EVX	1262	207	BR8EIX	5044
ZX 125 11PS	125	97 -	BR8ES	5422	0,6	BR8EVX	1262	207	BR8EIX	5044
ZX 125 15PS	125	97 -	BR9ES	5722	0,6	BR9EVX	1265	208	BR9EIX	3981
ZZ 125 Typ B	125	01 -	BR8ES	5422	0,8	BR8EVX	1262	207	BR8EIX	5044
ZZ 125 Typ A >10kW	125	01 -	BR9ES	5722	0,8	BR9EVX	1265	208	BR9EIX	3981
175 GS	175		B9ES	2611	0,5	B9EVX	7254	202	BR9EIX	3981
250 GS	250		B9ES	2611	0,5	B9EVX	7254	202	BR9EIX	3981
W 2000	294		BR7ES	5122	0,5					
350 GS	350				0,5	B9EVX	7254		BR9EIX	3981
Roadster 650	650	99 -	CR9E	6263	0,8	CR9EVX	5943	227	CR9EIX	3521
Roadster 800	800	01 -	DPR8EA-9	4929	0,9	DPR8EVX-9	2872	221	DPR8EIX-9	2202
SAN YANG										
Bullet 50 (G5A,B)	50		BR8HSA	5539	0,6	BR8HVX	6265		BR8HIX	7001
DIO (F5A,B,E)	50		BR8HSA	5539	0,6	BR8HVX	6265		BR8HIX	7001
SANGLAS										
350	350		BP6ES	7811	0,5	BP6EVX	5832		BPR6EIX	6637
400 E	400		BP6ES	7811	0,5	BP6EVX	5832		BPR6EIX	6637
400 Y (Motor Yamaha)	400		BP7ES	2412	0,7	BP7EVX	7270	206	BPR7EIX	4055
500 S/ S2-V5	500		BP6ES	7811	0,5	BP6EVX	5832		BPR6EIX	6637
SCORPA										
Easy Trail	250	94 -	BP5ES	6511	0,7	BP5EVX	5470		BPR5EIX	6597
SY 2001 (engine Yamaha TY250Z)	250	01 -			0,6	BCP6EVX	6323			
Easy Trail	280	94 -	BP5ES	6511	0,7	BP5EVX	5470		BPR5EIX	6597
SHERCO										
Trial Kid	50	02 -							BR9EIX	3981

					Order No.		Gold-Palladium	Platin 	Order No.	Quick-No.	Iridium 	Order No.
SHERCO												
City Corp 125	125	05 -	BP5ES	6511	0,7	BP5EVX	5470		5470		BPR5EIX	6597
Trail 1,2	125	00 -	BP5ES	6511	0,5	BP5EVX	5470		5470		BPR5EIX	6597
Scottish Six Days Winner	250	00 -	BP5ES	6511	0,5	BP5EVX	5470		5470		BPR5EIX	6597
Trail 2,5	250	00 -	BP5ES	6511	0,5	BP5EVX	5470		5470		BPR5EIX	6597
Trail 2,9	250	00 -	BP5ES	6511	0,5	BP5EVX	5470		5470		BPR5EIX	6597
4.5 4T	450	05 -	CR8EK	3478	0,7							
SHERCO- HRD												
Enduro	50	02 -	BR8ES	5422	0,5	BR8EVX	1262	207	BR8EIX		BR8EIX	5044
Super Motard	50	02 -	BR8ES	5422	0,5	BR8EVX	1262	207	BR8EIX		BR8EIX	5044
SIAMOTO												
Birdie 25 Mofa	25	99 -	BPR6HS	7022	0,6	BPR6HVX	2740	214	BPR6HIX		BPR6HIX	4085
Birdie 50 Mokick	50	99 -	BPR6HS	7022	0,6	BPR6HVX	2740	214	BPR6HIX		BPR6HIX	4085
SIMONINI IMEA												
Competizione Sachs	50		B10EGV	5927	0,5	B10EVX	7335					
Indian	50		B8HS	5510	0,5	B8HVX	2634	205	BR8HIX		BR8HIX	7001
Indian	50		B6HS	4510	0,6	B6HVX	7435	203	BR6HIX		BR6HIX	3419
Masetti Racing	50		B10EGV	5927	0,5	B10EVX	7335					
Masetti Strada	50		B10EGV	5927	0,5	B10EVX	7335					
Mustang Rino Baby	50		B8HS	5510	0,5	B8HVX	2634	205	BR8HIX		BR8HIX	7001
SF 150	50		B10EGV	5927	0,5	B10EVX	7335					
Speedy 2 Morini	50		B7HS	5110	0,5	B7HVX	7836	204	BR7HIX		BR7HIX	7067
Mustang Regolarita 125	125		B10EGV	5927	0,5	B10EVX	7335					
Diamond Sachs	250		B10EGV	5927	0,5	B10EVX	7335					
Hard Racer	250		B10EGV	5927	0,5	B10EVX	7335					
Mustang 250A	250		B10EGV	5927	0,5	B10EVX	7335					
Mustang 250H20	250		B10EGV	5927	0,5	B10EVX	7335					
Mustang Cross SA	250		B10EGV	5927	0,5	B10EVX	7335					
Mustang Cross SSH20	250		B10EGV	5927	0,5	B10EVX	7335					
Shadow 250	250		B10EGV	5927	0,5	B10EVX	7335					
SIMSON												
Albatros	50		B8HS	5510	0,4	B8HVX	2634	205	BR8HIX		BR8HIX	7001
AT 50	50	09.90 -	B8HS	5510	0,6	B8HVX	2634	205	BR8HIX		BR8HIX	7001
Bunny 50	50	01.87 -12.90	B8HS	5510	0,6	B8HVX	2634	205	BR8HIX		BR8HIX	7001
Habicht 25	50		B8HS	5510	0,4	B8HVX	2634	205	BR8HIX		BR8HIX	7001
Habicht 50	50		B8HS	5510	0,4	B8HVX	2634	205	BR8HIX		BR8HIX	7001
Habicht 50 Basic	50		B8HS	5510	0,4	B8HVX	2634	205	BR8HIX		BR8HIX	7001
Habicht 50 s	50		B8HS	5510	0,4	B8HVX	2634	205	BR8HIX		BR8HIX	7001
Kleinkraftrad	50		B8HS	5510	0,4	B8HVX	2634	205	BR8HIX		BR8HIX	7001
S 50 B1	50	01.75 -12.80	B8HS	5510	0,6	B8HVX	2634	205	BR8HIX		BR8HIX	7001
S 51 B2-4	50	01.82 -12.90	B8HS	5510	0,6	B8HVX	2634	205	BR8HIX		BR8HIX	7001
S 51 Enduro	50	01.81 -12.90	B8HS	5510	0,6	B8HVX	2634	205	BR8HIX		BR8HIX	7001
S 53	50	09.90 -	B8HS	5510	0,6	B8HVX	2634	205	BR8HIX		BR8HIX	7001
Sperber 50 Basic	50		B8HS	5510	0,4	B8HVX	2634	205	BR8HIX		BR8HIX	7001
SR 50	50	01.85 -12.90	B8HS	5510	0,6	B8HVX	2634	205	BR8HIX		BR8HIX	7001
SR 50 XC , XCE , XG	50	06.93 -	B8HS	5510	0,6	B8HVX	2634	205	BR8HIX		BR8HIX	7001
SR 50 , 1B , C,CE	50	09.90 -	B8HS	5510	0,6	B8HVX	2634	205	BR8HIX		BR8HIX	7001
SR 50 CC , CCE	50	01.93 -	B8HS	5510	0,6	B8HVX	2634	205	BR8HIX		BR8HIX	7001
Star 25	50	96 -	B8HS	5510	0,4	B8HVX	2634	205	BR8HIX		BR8HIX	7001

				Order No.		Gold-Palladium	Platin 	Order No.	Quick-No. 	Iridium	Order No.
SIMSON											
Star 25 Base E	50	96 -	B8HS	5510	0,4	B8HVX	2634	205	BR8HIX		7001
Star Classic 50	50	96 -	B8HS	5510	0,4	B8HVX	2634	205	BR8HIX		7001
Star Classic 50 Hot Summer	50	96 -	B8HS	5510	0,4	B8HVX	2634	205	BR8HIX		7001
Trucky SD 50 CT	50		B8HS	5510	0,4	B8HVX	2634	205	BR8HIX		7001
GS 75/1	70	01.75 - 12.90	B8HS	5510	0,6	B8HVX	2634	205	BR8HIX		7001
Leichtkraftrad	70		B8HS	5510	0,4	B8HVX	2634	205	BR8HIX		7001
S 70 C,C,E/2	70	01.80 - 12.90	B8HS	5510	0,6	B8HVX	2634	205	BR8HIX		7001
Habicht 80	80		B8HS	5510	0,4	B8HVX	2634	205	BR8HIX		7001
Habicht 80 Basic	80		B8HS	5510	0,4	B8HVX	2634	205	BR8HIX		7001
Habicht 80 s	80		B8HS	5510	0,4	B8HVX	2634	205	BR8HIX		7001
Hot Summer 80	80	96 -	B8HS	5510	0,4	B8HVX	2634	205	BR8HIX		7001
Sperber 80 Basic	80		B8HS	5510	0,4	B8HVX	2634	205	BR8HIX		7001
Star Classic 80	80	96 -	B8HS	5510	0,4	B8HVX	2634	205	BR8HIX		7001
SOLO											
712 Mofa	48		BR6HS	3922	0,7			209	BR6HIX		3419
713 Moped	48		BR7HS	4122	0,7			211	BR7HIX		7067
722 Mofa	48		BR6HS	3922	0,7			209	BR6HIX		3419
723 Moped	48		BR7HS	4122	0,7			211	BR7HIX		7067
SPARTA											
Buddy	50		B6HS	4510	0,6	B6HVX	7435	203	BR6HIX		3419
Happy	50		B6HS	4510	0,6	B6HVX	7435	203	BR6HIX		3419
Lucky	50		B6HS	4510	0,6	B6HVX	7435	203	BR6HIX		3419
Sport 2V	50		B6HS	4510	0,6	B6HVX	7435	203	BR6HIX		3419
Sport 3V	50		B6HS	4510	0,6	B6HVX	7435	203	BR6HIX		3419
Tour Automatica	50		B6HS	4510	0,6	B6HVX	7435	203	BR6HIX		3419
STARFLITE											
25 (Laura M48-15B)	50		B6HS	4510	0,6	B6HVX	7435	203	BR6HIX		3419
40 (Laura M48-11B)	50		B6HS	4510	0,6	B6HVX	7435	203	BR6HIX		3419
Bronco	50		B6HS	4510	0,6	B6HVX	7435	203	BR6HIX		3419
City Laura M48-15B	50		B6HS	4510	0,6	B6HVX	7435	203	BR6HIX		3419
GTM (F&S 501 BKF)	50		B6HS	4510	0,6	B6HVX	7435	203	BR6HIX		3419
GTS (F&S 50SA)	50		B8HS	5510	0,5	B8HVX	2634	205	BR8HIX		7001
Tramp (Laura M48-15)	50		B6HS	4510	0,6	B6HVX	7435	203	BR6HIX		3419
SUNDIRO											
Phönix XDZ 125 TN	125	96 -	DR8EA	7162	0,6	DR8EVX	6354		DR8EIX		6681
SUZUKI											
A 50 K	50		BR8HS	4322	0,7	BR8HVX	6265	212	BR8HIX		7001
A 50 P	50		BR7HS	4122	0,7			211	BR7HIX		7067
AE 50	50	93 -	BPR6HS	7022	0,7	BPR6HVX	2740	214	BPR6HIX		4085
AJ 50	50	95 -	BPR7HS	6422	0,6	BPR7HVX	2938	215	BPR7HIX		5944
AJ 50 ZZ	50	95 -	BPR7HS	6422	0,6	BPR7HVX	2938	215	BPR7HIX		5944
AP 50 (CA1JA)	50	95 -	BPR6HS	7022	0,7	BPR6HVX	2740	214	BPR6HIX		4085
CL 50 DO	50		BP4HS	3611	0,7						
CP 50 (CA14C/E)	50		BPR6HS	7022	0,7	BPR6HVX	2740	214	BPR6HIX		4085
CP 50 H-J,L/M/N	50		BPR6HS	7022	0,7	BPR6HVX	2740	214	BPR6HIX		4085
CS 50	50		BPR4HS	7823	0,7						
CX 50	50		BPR6HS	7022	0,7	BPR6HVX	2740	214	BPR6HIX		4085

					Order No.		Gold-Palladium	Platin 	Order No.	Quick-No.	Iridium 	Order No.
SUZUKI												
CY 50	50		BPR6HS	7022	0,7	BPR6HVX	2740	214	BPR6HIX	4085		
DM 50	50		BP6HS	4511	0,7	BP6HVX	4635		BPR6HIX	4085		
DR Big 50	50	89 -	BR7HS	4122	0,7			211	BR7HIX	7067		
DV 50	50		BP6ES	7811	0,7	BP6EVX	5832		BPR6EIX	6637		
FA 50	50		BPR4HS	7823	0,7							
FR 50	50		BPR4HS	7823	0,7							
FS 50	50		BP4HA	3511	0,7							
FZ 50	50		BPR4HS	7823	0,7							
GT 50	50		BP6HS	4511	0,7	BP6HVX	4635		BPR6HIX	4085		
JR 50	50	93 - 94	BP4H	3310	0,7							
JR 50	50	95 -	BPR4HS	7823	0,6							
JR 50 (JA143)	50		BPR4HS	7823	0,7							
K 50	50		BP7HS	5111	0,7	BP7HVX	7468		BPR7HIX	5944		
Katana AY50 aircooled	50	97 -	BPR6HS	7022	0,7	BPR6HVX	2740	214	BPR6HIX	4085		
Katana AY50 water (Spain)	50	97 -	BPR7HS	6422	0,7	BPR7HVX	2938	215	BPR7HIX	5944		
Katana AY50 watercooled	50	97 -	BPR6HS	7022	0,7	BPR6HVX	2740	214	BPR6HIX	4085		
LT 50 (ATV)	50		BPR4HS	7823	0,7							
Maxi 50	50		B7HS	5110	0,6	B7HVX	7836	204	BR7HIX	7067		
OR 50	50		BP6HS	4511	0,7	BP6HVX	4635		BPR6HIX	4085		
RB 50 GAG	50	88 - 88	CR6HS	7023	0,7			223	CR6HIX	7274		
RG 50 KE	50		BP8ES	2912	0,7	BP8EVX	2671					
RG 50 W	50		BPR8ES	3923	0,8	BPR8EVX	5573	213				
RM 50	50	90 -	BR7HS	4122	0,7			211	BR7HIX	7067		
RM 50	50	- 89	B7HS	5110	0,7	B7HVX	7836	204	BR7HIX	7067		
RV 50	50		BP6HS	4511	0,7	BP6HVX	4635		BPR6HIX	4085		
Suzu	50	95 -	BPR6HS	7022	0,7	BPR6HVX	2740	214	BPR6HIX	4085		
TR 50	50		BP4H	3310	0,7							
TR 50 S Magic	50	98 -	BPR6HS	7022	0,7	BPR6HVX	2740	214	BPR6HIX	4085		
TS 50 12,7mm	50		BP6HS	4511	0,7	BP6HVX	4635		BPR6HIX	4085		
TS 50 19,0mm	50		BP6ES	7811	0,8	BP6EVX	5832		BPR6EIX	6637		
TS 50 ER	50		BP6HS	4511	0,7	BP6HVX	4635		BPR6HIX	4085		
TS 50 XK (SA11C)	50		BP6ES	7811	0,7	BP6EVX	5832		BPR6EIX	6637		
ZR 50	50		BP6ES	7811	0,8	BP6EVX	5832		BPR6EIX	6637		
RM 65	65	04 -	BR10EG	3830	0,6							
CS 80	80		BPR6HS	7022	0,7	BPR6HVX	2740	214	BPR6HIX	4085		
DS 80	80	93 - 94	B7ES	1111	0,7	B7EVX	6934					
DS 80	80	95 -	BP7ES	2412	0,6	BP7EVX	7270	206	BPR7EIX	4055		
FR 80	80		BPR6HS	7022	0,7	BPR6HVX	2740	214	BPR6HIX	4085		
GT 80 EX/LX	80		B8ES	2411	0,7	B8EVX	7051	201	BR8EIX	5044		
JR 80 (K2)	80	02 -	BR7ES	5122	0,8							
LT 80 (ATV)	80		BPR7HS	6422	0,7	BPR7HVX	2938	215	BPR7HIX	5944		
RG 80 G (D) (NC11A)	80		BP7ES	2412	0,8	BP7EVX	7270	206	BPR7EIX	4055		
RG 80 Gamma	80		BP7ES	2412	0,8	BP7EVX	7270	206	BPR7EIX	4055		
RG 80 WF	80		BPR7ES	2023	0,8	BPR7EVX	5565		BPR7EIX	4055		
RM 80	80	93 -	B10ES	7928	0,8	B10EVX	7335		BR10EIX	6801		
RM 80 H	80		BR9ES	5722	0,8	BR9EVX	1265	208	BR9EIX	3981		
RM 80 X	80	91 -	BR10ES	4832	0,7	BR10EVX	3788		BR10EIX	6801		
RM 80 X	80	- 90	BR9ES	5722	0,8	BR9EVX	1265	208	BR9EIX	3981		
TS 80 ERX	80		B7ES	1111	0,8	B7EVX	6934					
TS 80 X (SA11A)	80		BP7ES	2412	0,7	BP7EVX	7270	206	BPR7EIX	4055		
TS 80 XE-H	80		BP8ES	2912	0,8	BP8EVX	2671					
RM 85 (K2)(K3)(K4)	85	02 -	BR10ES	4832	0,8	BR10EVX	3788		BR10EIX	6801		



Order No.



Gold-Palladium

Platin



Order No.

Quick-No.





Iridium



Order No.

SUZUKI

FM 90	90		BPR6HS	7022	0,7	BPR6HVX	2740	214	BPR6HIX	4085
RV 90	90		BP6HS	4511	0,6	BP6HVX	4635		BPR6HIX	4085
A 100	100	95 -	BP6HS	4511	0,6	BP6HVX	4635		BPR6HIX	4085
FB 100 / D	100	95 -	D8EA	2120	0,6	D8EVX	2850	216	DR8EIX	6681
GP 100	100		B8HS	5510	0,7	B8HVX	2634	205	BR8HIX	7001
RM 100	100				0,6	B9EGV	5827			
RM 100 X	100				0,6	B9EGV	5827			
TS 100 X	100	78 -	B8ES	2411	0,7	B8EVX	7051	201	BR8EIX	5044
TS 100 X	100	- 77	B8HS	5510	0,7	B8HVX	2634	205	BR8HIX	7001
DR-Z 110 (LX110A)	111	03 -	CR6HSA	2983	0,7				CR6HIX	7274
125 Van Van	125	03 -	CR8E	1275	0,6	CR8EVX	6487	226	CR8EIX	4218
CS 125	125		DR8ESL	2923	0,7	DR8EVX	6354	218	DR8EIX	6681
DR 125 S/L-N	125	91 -	DR8ESL	2923	0,7	DR8EVX	6354	218	DR8EIX	6681
DR 125 SE (SF44A)	125	95 -	DR8EA	7162	0,6	DR8EVX	6354		DR8EIX	6681
DR 125 SJ (SF43B)	125		DR8ESL	2923	0,7	DR8EVX	6354	218	DR8EIX	6681
GN 125	125	91 -	DR8ESL	2923	0,7	DR8EVX	6354	218	DR8EIX	6681
GN 125 V (NF41A)	125	97 -	DR8EA	7162	0,7	DR8EVX	6354		DR8EIX	6681
GP 125	125		B8HS	5510	0,7	B8HVX	2634	205	BR8HIX	7001
GS 125 S	125		DR8ESL	2923	0,9	DR8EVX	6354	218	DR8EIX	6681
GS 125 S	125	99 -	DR8EA	7162	0,7	DR8EVX	6354		DR8EIX	6681
GT 125,-E	125		B8HS	5510	0,7	B8HVX	2634	205	BR8HIX	7001
GZ 125 / U (AP) Marauder	125	99 -	DR8EA	7162	0,7	DR8EVX	6354		DR8EIX	6681
RG 125	125	01.85 -	BR9ES	5722	0,7	BR9EVX	1265	208	BR9EIX	3981
RM 125	125	93 - 95	R4118S-9	3245	0,6					
RM 125	125	87 - 92			0,6	BR9EVX	1265		BR9EIX	3981
RM 125	125	96 -	R6918B-8	4492	0,6					
RM 125	125	- 86			0,6	B9EGV	5827			
RV 125	125		B7HS	5110	0,6	B7HVX	7836	204	BR7HIX	7067
RC 125	125		B7HS	5110	0,6	B7HVX	7836	204	BR7HIX	7067
TS 125	125	01.75 - 12.85	BR8ES	5422	0,8	BR8EVX	1262	207	BR8EIX	5044
TS 125 R	125		BR9ES	5722	0,8	BR9EVX	1265	208	BR9EIX	3981
TS 125 RC,C2,ER	125	- 86	BR9ES	5722	0,7	BR9EVX	1265	208	BR9EIX	3981
TS 125 X	125		BR8ES	5422	0,8	BR8EVX	1262	207	BR8EIX	5044
TU 125 XT (AZ)	125	99 -	DR8EA	7162	0,7	DR8EVX	6354		DR8EIX	6681
UE 125 C (WVBH)	125	01 -	CR7E	4578	0,6		225		CR7EIX	7385
VL 125 LC Intruder	125	00 -	CR8E	1275	0,6	CR8EVX	6487	226	CR8EIX	4218
LT 160 E (ATV)	160	- 92	D7EA	7912	0,7	D7EVX	2734			
LT 160 E (ATV)	160	93 -	DPR7EA-9	5129	0,9	DPR7EVX-9	7682	220	DPR7EIX-9	7803
LT 160 F (ATV)	160	93 -	DP7EA-9	5629	0,9	DPR7EVX-9	7682		DPR7EIX-9	7803
LT-F 160 (ATV)	160	95 -	DP7EA-9	5629	0,9	DPR7EVX-9	7682		DPR7EIX-9	7803
PE 175	175	79 -			0,6	B10EGV	5927			
PE 175	175	78 - 78			0,6	B8EGV	5627			
GT 185	185		B7HS	5110	0,7	B7HVX	7836	204	BR7HIX	7067
TS 185 ER	185	93 -	BP7ES	2412	0,8	BP7EVX	7270	206	BPR7EIX	4055
DR 200 SZ	200	95 -	DR8EA	7162	0,6	DR8EVX	6354		DR8EIX	6681
GT 200	200		B8ES	2411	0,8	B8EVX	7051	201	BR8EIX	5044
TS 200	200		BR9ES	5722	0,8	BR9EVX	1265	208	BR9EIX	3981
LT 230 E (ATV)	230	93 -	D7EA	7912	0,7	D7EVX	2734			
LT 230 E/F (ATV)	230		DR7ES	3123	0,7					
LT 230 GE (ATV)	230		D7EA	7912	0,7	D7EVX	2734			
DR 250	250	91 -	DPR9EA-9	5329	0,9	DPR9EVX-9	3854	222	DPR9EIX-9	5545
DR 250 S	250	90 -	DPR9EA-9	5329	0,9	DPR9EVX-9	3854	222	DPR9EIX-9	5545

					Order No.		Platin 	Order No.	Quick-No.	Iridium 	Order No.
SUZUKI											
DR 250 S (SJ42A)	250		DR8ESL	2923	0,7	DR8EVX	6354	218	DR8EIX	6681	
DR 250 SZ	250	95 -	DPR9EA-9	5329	0,8	DPR9EVX-9	3854	222	DPR9EIX-9	5545	
DR 250 SZ-H	250		DR8ESL	2923	0,7	DR8EVX	6354	218	DR8EIX	6681	
GN 250 EZ-J	250		DR8ESL	2923	0,7	DR8EVX	6354	218	DR8EIX	6681	
GN 250 L-N (NJ42A)	250	- 97	DR8ESL	2923	0,7	DR8EVX	6354	218	DR8EIX	6681	
GN 250 (NJ42A)	250	98 -	DR8EA	7162	0,7	DR8EVX	6354		DR8EIX	6681	
GNX 250	250	01.82 -12.84	DR8ESL	2923	0,7	DR8EVX	6354	218	DR8EIX	6681	
GSX 250 EZ (GJ53B)	250		DR8ES	5423	0,7	DR8EVX	6354	217	DR8EIX	6681	
GSX 250 L	250		DR8ES	5423	0,7	DR8EVX	6354	217	DR8EIX	6681	
GSX 250 T/ET 1	250		DR8ES	5423	0,7	DR8EVX	6354	217	DR8EIX	6681	
GZ 250 (JS1AR)	250	99 -	DR8EA	7162	0,7	DR8EVX	6354		DR8EIX	6681	
LT 250 4WD/F4WD (ATV)	250	- 94	DR7ES	3123	0,7						
LT 250 E/EF (ATV)	250	93 -	D8EA	2120	0,7	D8EVX	2850	216	DR8EIX	6681	
LT 250 EF (ATV)	250		DR8ESL	2923	0,7	DR8EVX	6354	218	DR8EIX	6681	
LT 250 R (ATV)	250				0,6	BR8EVX	1262		BR8EIX	5044	
LT 250 R (ATV)	250	93 -			0,6	B9EGV	5827				
LT 250 S (ATV)	250		DPR7EA-9	5129	0,9	DPR7EVX-9	7682	220	DPR7EIX-9	7803	
LTF 250 (ATV)	250	93 -	DR7ES	3123	0,7						
LTF 250 (ATV)	250	- 94	DR7ES	3123	0,7						
LTF 250 (ATV)	250	95 -	D7EA	7912	0,6	D7EVX	2734				
PE 250	250	80 -			0,6	B10EGV	5927				
PE 250	250	- 78			0,6	B8EGV	5627				
PE 250	250	79 - 79			0,6	B9EGV	5827				
RG 250 CH/FCH (GJ21D)	250		BR9ES	5722	0,7	BR9EVX	1265	208	BR9EIX	3981	
RG 250 G-CH	250		BR9ES	5722	0,8	BR9EVX	1265	208	BR9EIX	3981	
RG 250 WE (GJ21A)	250		BR9ES	5722	0,8	BR9EVX	1265	208	BR9EIX	3981	
RGV 250 L (VJ21A)	250	90 - 90	BR9ES	5722	0,8	BR9EVX	1265	208	BR9EIX	3981	
RGV 250 M-N (VJ22B)	250	91 -	BR9ECM	3252	0,8	BR9ECMVX	2434				
RM 250 (JS1RJ18A)(K2,K3,K4)	250	01 - 03	BR8EG	3130	0,6						
RM 250	250	- 81			0,6	B9EGV	5827				
RM 250	250	82 - 92			0,6	B8EGV	5627				
RM 250	250	93 - 00	R4118S-8	3236	0,6						
RMX 250	250				0,6	B9EGV	5827				
RM-Z 250	250	04 -	CR8EB	7784	0,6	CR8EVX	6487		CR8EIX	4218	
TS 250 X G-K (SJ11D)	250		BR9ES	5722	0,8	BR9EVX	1265	208	BR9EIX	3981	
LT-4 WDX (ATV)	280	95 -	D7EA	7912	0,6	D7EVX	2734				
LT-4WD / F4WD (ATV)	280	95 -	DR7EA	7839	0,6						
LT-F4WDX (ATV)	280	93 - 94	DR7ES	3123	0,7						
LT-300 (ATV)	300	87 - 89	D8EA	2120	0,6	D8EVX	2850	216	DR8EIX	6681	
LT-F 300 (ATV)	300	99 -	D7EA	7912	0,6	D7EVX	2734				
350 Goose	350	93 -	CR9EK	4548	0,7		230		CR9EIX	3521	
DR 350	350	95 -	CR9EK	4548	0,6		230		CR9EIX	3521	
DR 350 S/L-P (SK42B)	350	91 -	DPR9EA-9	5329	0,9	DPR9EVX-9	3854	222	DPR9EIX-9	5545	
DR 350 SH/N/S	350	90 -	DPR9EA-9	5329	0,9	DPR9EVX-9	3854	222	DPR9EIX-9	5545	
DR 350 SZ	350	95 -	CR9EK	4548	0,6		230		CR9EIX	3521	
DR 400 S	400	01.80 -12.83	DR8ESL	2923	0,7	DR8EVX	6354	218	DR8EIX	6681	
DR-Z 400 (WVBC)	400	00 -	CR8E	1275	0,6	CR8EVX	6487	226	CR8EIX	4218	
DR-Z 400 S (WVBC)	400	00 -	CR8E	1275	0,6	CR8EVX	6487	226	CR8EIX	4218	
DR-Z 400 SM K5 (WVB8)	400	05 -	CR8E	1275	0,6	CR8EVX	6487	226	CR8EIX	4218	
GN 400 TD-X	400		DR8ESL	2923	0,7	DR8EVX	6354	218	DR8EIX	6681	
GS 400 R/C/EC/N/EN	400		B8ES	2411	0,7	B8EVX	7051	201	BR8EIX	5044	
GS 400 TX	400		B8ES	2411	0,7	B8EVX	7051	201	BR8EIX	5044	



Order No.



Gold-Palladium

Platin



Order No.

Quick-No.









Iridium

















Order No.







SUZUKI







GSF 400 (BANDIT GK75B)	400	-	92	CR8EK	3478	0,7							
GSF 400 (BANDIT GK75B)	400	92 -		CR9EK	4548	0,7			230	CR9EIX	3521		
GSX 400 E (GS40X)	400	01.83 -		DR8ESL	2923	0,7	DR8EVX	6354	218	DR8EIX	6681		
GSX 400 FW	400			CR8HS	7423	0,7	CR8HVX	7236		CR8HIX	7669		
GSX 400 FX	400			DR8ESL	2923	0,6	DR8EVX	6354	218	DR8EIX	6681		
GSX 400 LX	400			DR8ESL	2923	0,7	DR8EVX	6354	218	DR8EIX	6681		
GSX 400 S	400			DR8ESL	2923	0,6	DR8EVX	6354	218	DR8EIX	6681		
GSX 400 SE/EF (GK53C)	400			DR8ESL	2923	0,7	DR8EVX	6354	218	DR8EIX	6681		
GSX-R400	400	93 -		CR9EK	4548	0,7			230	CR9EIX	3521		
GSX-R400	400			CR8EK	3478	0,7							
LT-A 400 (ATV)	400	02 -		CR7E	4578	0,6			225	CR7EIX	7385		
LT-A 400F (ATV)	400	02 -		CR7E	4578	0,6			225	CR7EIX	7385		
LT-F 400F (ATV)	400	02 -		CR7E	4578	0,6			225	CR7EIX	7385		
LT-F 400 (ATV)	400	02 -		CR7E	4578	0,6			225	CR7EIX	7385		
LT-Z 400 (ATV)	400	02 -		CR7E	4578	0,6			225	CR7EIX	7385		
VS 400	400	95 -		DPR8EA-9	4929	0,8	DPR8EVX-9	2872	221	DPR8EIX-9	2202		
GS 450 E/ES (GS450)	450			B8ES	2411	0,7	B8EVX	7051	201	BR8EIX	5044		
GS 450 L (GL51D)	450			B8ES	2411	0,7	B8EVX	7051	201	BR8EIX	5044		
GS 450 LT/X (GS450)	450			B8ES	2411	0,7	B8EVX	7051	201	BR8EIX	5044		
GS 450 SF	450			BR8ES	5422	0,7	BR8EVX	1262	207	BR8EIX	5044		
GS 450 TX	450			B8ES	2411	0,7	B8EVX	7051	201	BR8EIX	5044		
RM-Z 450 K5 (RL41A)	450	05 -		CR8EIB-10		1,0	CR8EIB-10						
RM 495	495					0,5	B8EGV	5627					
DR 500 S (D)	500			DR8ESL	2923	0,7	DR8EVX	6354	218	DR8EIX	6681		
DR 500 S (I)	500			D8EA	2120	0,7	D8EVX	2850	216	DR8EIX	6681		
DR 500 SX-Z	500			DR8ESL	2923	0,7	DR8EVX	6354	218	DR8EIX	6681		
GS 500 E	500	-	00	B8ES	2411	0,7	B8EVX	7051	201	BR8EIX	5044		
GS 500 E (GM51B)	500	93 -	00	DPR8EA-9	4929	0,9	DPR8EVX-9	2872	221	DPR8EIX-9	2202		
GS 500 F	500	04 -		DPR8EA-9	4929	0,9	DPR8EVX-9	2872	221	DPR8EIX-9	2202		
LT-A 500F (ATV)	500	00 -		CR6E	6965	0,6							
LT-F 500F (ATV)	500	00 -		CR6E	6965	0,6							
LT-F 500 (ATV)	500	98 -	99	CR7E	4578	0,6			225	CR7EIX	7385		
RG 500	500	87 -	87	BR9ES	5722	0,8	BR9EVX	1265	208	BR9EIX	3981		
RM 500	500					0,5	B8EGV	5627					
GS 550 MX/LN/T	550			B8ES	2411	0,7	B8EVX	7051	201	BR8EIX	5044		
GSX 550 (GN71D)	550			DR8ES	5423	0,7	DR8EVX	6354	217	DR8EIX	6681		
GSX 550 EF (I)	550			DP9EA-9	6629	0,9	DP9EVX-9	3331		DPR9EIX-9	5545		
GT 550	550	01.73 -	12.77	B8ES	2411	0,7	B8EVX	7051	201	BR8EIX	5044		
DR 600	600			DPR9EA-9	5329	0,9	DPR9EVX-9	3854	222	DPR9EIX-9	5545		
DR 600 R Djebel (I)	600			DPR9EA-9	5329	0,9	DPR9EVX-9	3854	222	DPR9EIX-9	5545		
DR 600 S (SN41A)	600			DPR9EA-9	5329	0,9	DPR9EVX-9	3854	222	DPR9EIX-9	5545		
GSF 600 Y (VVA8)	600	00 -		CR9EK	4548	0,6			230	CR9EIX	3521		
GSF 600 (GN77B)	600	95 -		CR9EK	4548	0,7			230	CR9EIX	3521		
GSF 600 (K2)	600	02 -		CR9EK	4548	0,6			230	CR9EIX	3521		
GSF 600 S (K2)	600	02 -		CR9EK	4548	0,6			230	CR9EIX	3521		
GSX 600 F (W)	600	98 -		CR9EK	4548	0,7			230	CR9EIX	3521		
GSX 600 F/FU/FU2 (GN72B)	600			DR8ES	5423	0,7	DR8EVX	6354	217	DR8EIX	6681		
GSX-R 600 (JS1AD)	600	97 -	00	CR9E	6263	0,7	CR9EVX	5943	227	CR9EIX	3521		
GSX-R 600 (W) (JS1BG)/(WVBG)	600	98 -		CR9E	6263	0,7	CR9EVX	5943	227	CR9EIX	3521		
RF 600 R / RU (GN76B)	600	93 -		CR9E	6263	0,7	CR9EVX	5943	227	CR9EIX	3521		
VS 600 (VN51B)	600	95 -		DPR8EA-9	4929	0,9	DPR8EVX-9	2872	221	DPR8EIX-9	2202		
DL 650 V-strom (K4)	650	04 -		CR8E	1275	0,8	CR8EVX	6487	226	CR8EIX	4218		







					Order No.		Platin 	Order No.	Quick-No.	Iridium 	Order No.
SUZUKI											
DR 650 R/RU (SP41B)	650		DPR9EA-9	5329	0,9	DPR9EVX-9	3854	222	DPR9EIX-9		5545
DR 650 R/RU (SP44B)	650		DPR9EA-9	5329	0,9	DPR9EVX-9	3854	222	DPR9EIX-9		5545
DR 650 RE (SP45B)	650	94 -	DPR9EA-9	5329	0,9	DPR9EVX-9	3854	222	DPR9EIX-9		5545
DR 650 RS/RSU (SP42B)	650	91 -	DPR9EA-9	5329	0,9	DPR9EVX-9	3854	222	DPR9EIX-9		5545
DR 650 RSE/RSEU (SP43B)	650	90 -	DPR9EA-9	5329	0,9	DPR9EVX-9	3854	222	DPR9EIX-9		5545
DR 650 SET	650	96 - 00	CR9E	6263	0,6	CR9EVX	5943	227	CR9EIX		3521
GR 650 D/XD/XF (GP51A)	650		DR8ESL	2923	0,6	DR8EVX	6354	218	DR8EIX		6681
GS 650 G	650		DR8ESL	2923	0,6	DR8EVX	6354	218	DR8EIX		6681
GSF 650 / S K5 (WVB5)	650	05 -	CR8EK	3478	0,6						
LS 650 (NP41B)	650	- 00	DPR8EA-9	4929	0,9	DPR8EVX-9	2872	221	DPR8EIX-9		2202
SV 650 (K3)	650	03 -	CR8E	1275	0,7	CR8EVX	6487	226	CR8EIX		4218
SV 650 S (K3)	650	03 -	CR8E	1275	0,7	CR8EVX	6487	226	CR8EIX		4218
SV 650 S (AV)	650	99 -	CR9E	6263	0,6	CR9EVX	5943	227	CR9EIX		3521
SV 650 SU (AV)	650	99 -	CR9E	6263	0,6	CR9EVX	5943	227	CR9EIX		3521
XF 650 (JS1AC) Freewind	650	97 -	CR9EK	4548	0,7				230	CR9EIX	3521
DR 750 S (DR BIG SR41B)	750		DPR9EA-9	5329	0,9	DPR9EVX-9	3854	222	DPR9EIX-9		5545
GS 750 D/E/L	750		B8ES	2411	0,7	B8EVX	7051	201	BR8EIX		5044
GSX 750 E	750		DR8ESL	2923	0,6	DR8EVX	6354	218	DR8EIX		6681
GSX 750 E (I)	750		D8EA	2120	0,7	D8EVX	2850	216	DR8EIX		6681
GSX 750 EF	750	- 85	DR8ESL	2923	0,7	DR8EVX	6354	218	DR8EIX		6681
GSX 750 ES (I)	750		D8EA	2120	0,7	D8EVX	2850	216	DR8EIX		6681
GSX 750 F (GR78A)	750	89 -	JR9C	6193	0,7						
GSX 750 S	750		DR8ESL	2923	0,6	DR8EVX	6354	218	DR8EIX		6681
GSX 750 S Katana (I)	750		DR8EA	7162	0,7	DR8EVX	6354		DR8EIX		6681
GSX 750 T	750		DR8ESL	2923	0,6	DR8EVX	6354	218	DR8EIX		6681
GSX 750 (W)(AK)	750	98 -	CR9EK	4548	0,7				230	CR9EIX	3521
GSX R 750 (GR75A)	750	- 87	DR8ES	5423	0,7	DR8EVX	6354	217	DR8EIX		6681
GSX R 750 (GR77B)	750	88 -	JR9C	6193	0,7						
GSX-R 750 Y (WVBD)	750	00 -	CR9E	6263	0,7	CR9EVX	5943	227	CR9EIX		3521
GSX-R 750 (GR7AB)	750	91 -	CR10EK	2360	0,7					CR10EIX	6482
GSX-R 750 J-K	750		JR9B	3188	0,7				224		
GSX-R 750 R	750	89 -	CR10EK	2360	0,7					CR10EIX	6482
GSX-R 750 RG (GR75A)(GR79B)	750		DR8ES	5423	0,7	DR8EVX	6354	217	DR8EIX		6681
GSX-R 750 T	750	96 -	CR9E	6263	0,6	CR9EVX	5943	227	CR9EIX		3521
GSX-R 750 W	750	95 -	CR9E	6263	0,6	CR9EVX	5943	227	CR9EIX		3521
GSX-R 750 (W)	750	98 -	CR9E	6263	0,7	CR9EVX	5943	227	CR9EIX		3521
GSX-R 750 W (GR7BB)	750	- 93	CR9EK	4548	0,7				230	CR9EIX	3521
VS 750 GL/H/J-K	750		DPR9EA-9	5329	0,9	DPR9EVX-9	3854	222	DPR9EIX-9		5545
DR 800 S/SU L (SR42B)	773	90 -	DPR9EA-9	5329	0,9	DPR9EVX-9	3854	222	DPR9EIX-9		5545
DR 800 S/SU M-N (SR43B)	800		DPR9EA-9	5329	0,9	DPR9EVX-9	3854	222	DPR9EIX-9		5545
VL 800 (K2;K5) (WVBM) Intruder C800	800	01 -	DPR7EA-9	5129	0,9	DPR7EVX-9	7682	220	DPRT7EIX-9		7803
VS 800 N-P (VS52B)	800	92 - 00	DPR8EA-9	4929	0,9	DPR8EVX-9	2872	221	DPR8EIX-9		2202
VX 800/J (VS51B)	800		DPR8EA-9	4929	0,9	DPR8EVX-9	2872	221	DPR8EIX-9		2202
VZ 800 (JS1AF)Marauder	800	97 -	DPR8EA-9	4929	0,9	DPR8EVX-9	2872	221	DPR8EIX-9		2202
VZ 800/ U K5 Intruder M800 (WVB4)	800	05 -	DPR7EA-9	5129	0,9	DPRT7EVX-9	7682	220	DPRT7EIX-9		7803
GS 850 G (GS72A)	850		B8ES	2411	0,7	B8EVX	7051	201	BR8EIX		5044
GS 850 GL	850		B8ES	2411	0,7	B8EVX	7051	201	BR8EIX		5044
GS 850 GT E-G (GS72A)	850		B9ES	2611	0,7	B9EVX	7254	202	BR9EIX		3981
RF 900 R (GT73B)	900	94 -	CR9E	6263	0,7	CR9EVX	5943	227	CR9EIX		3521
GS 1000 D/E/H/S-1980/GL/GX	1000		B8ES	2411	0,7	B8EVX	7051	201	BR8EIX		5044
GSX 1000 E	1000	86 -	DPR9EA-9	5329	0,9	DPR9EVX-9	3854	222	DPR9EIX-9		5545
GSX R 1000	1000	- 99	JR9B	3188	0,7				224		







				Order No.		Gold-Palladium	Platin 	Order No.	Quick-No.	Iridium 	Order No.
SUZUKI											
GSX R 1000 (WVBL) Fuel Injection	1000	01 -	CR9E	6263	0,7	CR9EVX	5943	227	CR9EIX	3521	
GSX-R 1000 (K3) (WVBZ)	1000	03 -	CR9E	6263	0,7	CR9EVX	5943	227	CR9EIX	3521	
SV 1000 (WVBX)	1000	03 -	CR8EK	3478	0,7						
SV 1000 S (WVBX)	1000	03 -	CR8EK	3478	0,7						
TL 1000 R (W)	1000	98 -	CR9EK	4548	0,7			230	CR9EIX	3521	
TL 1000 S (JS1AG)	1000	97 - 00	CR8EK	3478	0,7						
V-Strom 1000	1000	02 -	CR8EK	3478	0,7						
GS 1100 E,GSX 1100 E	1100		DR8ESL	2923	0,6	DR8EVX	6354	218	DR8EIX	6681	
GS 1100 G /GG (GU71A)	1100		B8ES	2411	0,8	B8EVX	7051	201	BR8EIX	5044	
GS 1100 GT	1100		B8ES	2411	0,7	B8EVX	7051	201	BR8EIX	5044	
GSX 1100 EFE (I)	1100		D8EA	2120	0,7	D8EVX	2850	216	DR8EIX	6681	
GSX 1100 EFG/ESG/EG(GV71C)	1100		DR8ES	5423	0,7	DR8EVX	6354	217	DR8EIX	6681	
GSX 1100 EZ/ESD (GU71B)	1100		DR8ESL	2923	0,6	DR8EVX	6354	218	DR8EIX	6681	
GSX 1100 F (GV72C)72-100kW	1100		JR9B	3188	0,7			224			
GSX 1100 G L-N (GV74A)	1100		JR9B	3188	0,7			224			
GSX 1100 S/SZ Kata.(GS110XS)	1100		D8EA	2120	0,7	D8EVX	2850	216	DR8EIX	6681	
GSX-K 1100 (I)	1100		JR9B	3188	0,7			224			
GSX R-1100 W (GU75C)	1100	93 -	CR9E	6263	0,7	CR9EVX	5943	227	CR9EIX	3521	
GSX-R 1100 (GU74C,GV73C)	1100		JR9B	3188	0,7			224			
GS 1150 EF (NL,I)	1150		D9EA	2420	0,7	D9EVX	2834		DR9EIX	4772	
GS 1150 ES (NL,I)	1150		D9EA	2420	0,7	D9EVX	2834		DR9EIX	4772	
GSX 1150 E	1150	86 -	DPR9EA-9	5329	0,9	DPR9EVX-9	3854	222	DPR9EIX-9	5545	
GSX 1150 E	1150	- 85	DR8ES	5423	0,7	DR8EVX	6354	217	DR8EIX	6681	
GSX 1150 EF	1150		DR8ES	5423	0,7	DR8EVX	6354	217	DR8EIX	6681	
GSX 1150 ES	1150		DR8ES	5423	0,7	DR8EVX	6354	217	DR8EIX	6681	
GSF 1200 / S (JS1A9..)(WVA9)	1200	01 -	JR9B	3188	0,7			224			
GSF 1200 /S/SA	1200	96 -	JR9B	3188	0,7			224			
GSX 1200	1200		JR8B	7237	0,7						
GV 1200 GL	1200	86 -	DR8ESL	2923	0,7	DR8EVX	6354	218	DR8EIX	6681	
GSX 1300 R Hayabusa (WV A1)	1300	99 -	CR9E	6263	0,7	CR9EVX	5943	227	CR9EIX	3521	
GSX 1400	1400	01 -	CR8EK	3478	0,7						
VS 1400 GLP H-J (VX51L)	1400		DPR8EA-9	4929	0,9	DPR8EVX-9	2872	221	DPR8EIX-9	2202	
VL 1500 Intruder LC	1500	98 - 04	DPR7EA-9	5129	0,9	DPR7EVX-9	7682	220	DPR7EIX-9	7803	
VL 1500 K5 (WVAL) Intruder C 1500	1500	05 -	DPR7EA-9	5129	0,9	DPR7EVX-9	7682	220	DPR7EIX-9	7803	
VZ 1600 Marauder 1600	1600	04 -	DPR6EA-9	5531	0,9						
SV											
Dakar 2/3	35		BPM6A	7021	0,5						
Triciclo Mini-Dakar	35		BPM6A	7021	0,5						
SWM											
TLM 125	125		BP5ES	6511	0,4	BP5EVX	5470		BPR5EIX	6597	
TL 200	200		BP5ES	6511	0,4	BP5EVX	5470		BPR5EIX	6597	
TL 240	240		BP5ES	6511	0,4	BP5EVX	5470		BPR5EIX	6597	
TLM 320	320		BP5ES	6511	0,4	BP5EVX	5470		BPR5EIX	6597	
TL 350	350		BP5ES	6511	0,4	BP5EVX	5470		BPR5EIX	6597	
SYM											
Husky	125	97 -	DR8EA	7162	0,7	DR8EVX	6354		DR8EIX	6681	







					Order No.		Platin 	Order No.	Quick-No. 	Iridium 	Order No.
TESTI											
Amico (Minarelli V1)	50		B5HS	4210	0,5						
Carabo CR (8.5PS)	50		B8HS	5510	0,5	B8HVX	2634	205	BR8HIX		7001
Carabo(Minarelli P4A)	50		B6HS	4510	0,6	B6HVX	7435	203	BR6HIX		3419
Carabo(Minarelli P6CS)	50		B6HS	4510	0,6	B6HVX	7435	203	BR6HIX		3419
Carabo(Minarelli P6RAD)	50		B6ES	7310	0,7	B6EVX	5136				
Champion Special(Minarelli P6CS)	50		B6HS	4510	0,6	B6HVX	7435	203	BR6HIX		3419
Champion Special(Minarelli P6RAD)	50		B6ES	7310	0,7	B6EVX	5136				
Champion(Minarelli P4/P6RAD)	50		B6ES	7310	0,7	B6EVX	5136				
Champion(Minarelli P4A/CS)	50		B6HS	4510	0,6	B6HVX	7435	203	BR6HIX		3419
Champion(Minarelli P6A/CS)	50		B6HS	4510	0,6	B6HVX	7435	203	BR6HIX		3419
Confort (Minarelli V1N)	50		B5HS	4210	0,5						
Confort(Minarelli P3NK)	50		B6HS	4510	0,6	B6HVX	7435	203	BR6HIX		3419
Corsa (8.5PS)	50		B8HS	5510	0,5	B8HVX	2634	205	BR8HIX		7001
Criket (Minarelli V1AK/NK)	50		B5HS	4210	0,5						
Criket(Minarelli P4A)	50		B6HS	4510	0,6	B6HVX	7435	203	BR6HIX		3419
Criket(Minarelli P4CS/RAD)	50		B6ES	7310	0,7	B6EVX	5136				
Gran Prix(Minarelli P4A)	50		B6HS	4510	0,6	B6HVX	7435	203	BR6HIX		3419
IO (Minarelli V1AKS)	50		B5HS	4210	0,5						
Jeans(Minarelli P4/P6 RAD)	50		B6ES	7310	0,7	B6EVX	5136				
Mini Criquet (Minarelli V1N/AK)	50		B5HS	4210	0,5						
O.K.C. (Minarelli C2)	50		B5HS	4210	0,5						
O.K.S. (Minarelli V1N)	50		B5HS	4210	0,5						
Pull (Minarelli V1NK)	50		B5HS	4210	0,5						
Grand Touring (Minarelli)	80		B8HS	5510	0,5	B8HVX	2634	205	BR8HIX		7001
2000 Special	125		B8ES	2411	0,5	B8EVX	7051	201	BR8EIX		5044
Corsa	125		B8ES	2411	0,5	B8EVX	7051	201	BR8EIX		5044
Corsa Easy Rider	125		B8ES	2411	0,5	B8EVX	7051	201	BR8EIX		5044
TGB											
202T big wvvels	50	98 -	BPR7HS	6422	0,8	BPR7HVX	2938	215	BPR7HIX		5944
Ergon	50	98 -	BPR7HS	6422	0,8	BPR7HVX	2938	215	BPR7HIX		5944
202T Palio	125	98 -	C7HSA	4629	0,7	C7HVX	4533		CR7HIX		7544
TITAN											
Coyote	1573	97 - 03	BPR5ES	7422	0,7	BPR5EVX	4875		BPR5EIX		6597
Gecko	1573	97 - 03	BPR5ES	7422	0,7	BPR5EVX	4875		BPR5EIX		6597
Roadrunner	1573	97 - 03	BPR5ES	7422	0,7	BPR5EVX	4875		BPR5EIX		6597
Scorpion	1573	97 - 03	BPR5ES	7422	0,7	BPR5EVX	4875		BPR5EIX		6597
Sidewinder	1573	97 - 03	BPR5ES	7422	0,7	BPR5EVX	4875		BPR5EIX		6597
TM											
Cross, Enduro	80	94 -	B9EG	3530	0,6	B9EGV	5827		BR9EIX		3981
125 EN	125	03 -	BR9EG	3230	0,6	BR9EVX	1265		BR9EIX		3981
Cross, Enduro	125	94 -	B10EG	3630	0,6	B10EGV	5927				
250 EN	250	03 -	BR8EG	3130	0,5						
250 EN-F	250	04 -	CR8E	1275	0,7	CR8EVX	6487	226	CR8EIX		4218
Cross, Enduro	250	94 -	B9EG	3530	0,6	B9EGV	5827		BR9EIX		3981
300 EN	300	03 -	BR8EG	3130	0,5						
Cross, Enduro	300		B9EG	3530	0,6	B9EGV	5827		BR9EIX		3981
450 EN-F	450	04 -	CR8E	1275	0,7	CR8EVX	6487	226	CR8EIX		4218







				Order No.		Platin 	Order No.	Quick-No.	Iridium 	Order No.
TOKAIDO										
RC 25	25		B5HS	4210	0,8					
TOMOS										
Forza	49		BPR8HS	3725	0,6				BPR8HIX	6742
Quadro 25	49		B6HS	4510	0,6	B6HVX	7435	203	BR6HIX	3419
Tomos	50		B7HS	5110	0,5	B7HVX	7836	204	BR7HIX	7067
Tomos Cross	50		B8HS	5510	0,5	B8HVX	2634	205	BR8HIX	7001
Tomos	80		B7HS	5110	0,5	B7HVX	7836	204	BR7HIX	7067
TORROT										
Ciclomatic/ 2VL	50		B7HS	5110	0,5	B7HVX	7836	204	BR7HIX	7067
City CX/N/SL/X	50		B7HS	5110	0,5	B7HVX	7836	204	BR7HIX	7067
City/LJ/2V/2V-TT	50		B6HS	4510	0,5	B6HVX	7435	203	BR6HIX	3419
Cycloscooter S50/HL	50		B6HS	4510	0,5	B6HVX	7435	203	BR6HIX	3419
Gran Cross, Maxi, Mini	50		B5HS	4210	0,5					
Mustang, Panther, Tiburon	50		B5HS	4210	0,5					
Sport Sachs TX50, TT50	50		B7HS	5110	0,5	B7HVX	7836	204	BR7HIX	7067
Super Cross/Rally Sachs	50		B7HS	5110	0,5	B7HVX	7836	204	BR7HIX	7067
Trial, Turismo	50		B5HS	4210	0,5					
TRAILBLAZER										
170 (ATV)	170	04 -	DR8EA	7162	0,7	DR8EVX	6354		DR8EIX	6681
TRAILSPORT										
TS-500 5.0hp (ATV)		04 -	BR2LM	5798	0,6			310		
TSB-600 6.0hp (ATV)		04 -	BR2LM	5798	0,6			310		
TRIUMPH										
Daytona 600	600	03 -	CR9EK	4548	0,7			230	CR9EIX	3521
Speed Four	600	02 -	CR9EK	4548	0,7			230	CR9EIX	3521
Speed Triple S	600	02 -	CR9EK	4548	0,7			230	CR9EIX	3521
Supersport	600	01 -	CR9EK	4548	0,7			230	CR9EIX	3521
TT 600 (806AD)	600	00 -	CR9EK	4548	0,7			230	CR9EIX	3521
Bonneville T120, R, V	650		B8ES	2411	0,5	B8EVX	7051	201	BR8EIX	5044
Tiger, Trophy Sport TR6C	650		B8ES	2411	0,5	B8EVX	7051	201	BR8EIX	5044
Trophy TR6 --> Nr.029363	650		B7HS	5110	0,5	B7HVX	7836	204	BR7HIX	7067
Trophy TR6 Nr.029364 -->	650		B7ES	1111	0,5	B7EVX	6934			
Bonneville T140D/E	750		B6ES	7310	0,5	B6EVX	5136			
Bonneville T140V	750		B8ES	2411	0,5	B8EVX	7051	201	BR8EIX	5044
Daytona 750	750	91 -	DPR8EA-9	4929	0,9	DPR8EVX-9	2872	221	DPR8EIX-9	2202
Hurricane TRX75	750		B8ES	2411	0,5	B8EVX	7051	201	BR8EIX	5044
Speed Triple 750	750	97 -	DPR8EA-9	4929	0,9	DPR8EVX-9	2872	221	DPR8EIX-9	2202
Sprint RS	750	99 -	DPR8EA-9	4929	0,9	DPR8EVX-9	2872	221	DPR8EIX-9	2202
Tiger TR7RV, TR7V	750		B8ES	2411	0,5	B8EVX	7051	201	BR8EIX	5044
Trident T150V, T160	750		B8ES	2411	0,5	B8EVX	7051	201	BR8EIX	5044
Trident 750	750	91 -	DPR8EA-9	4929	0,9	DPR8EVX-9	2872	221	DPR8EIX-9	2202
Bonneville (908MD)	790	00 -	DPR8EA-9	4929	0,9	DPR8EVX-9	2872	221	DPR8EIX-9	2202
Bonneville America(908M)	790	02 -	DPR8EA-9	4929	0,9	DPR8EVX-9	2872	221	DPR8EIX-9	2202
Bonneville T100	790	02 -	DPR8EA-9	4929	0,9	DPR8EVX-9	2872	221	DPR8EIX-9	2202
Speedmaster	790	02 -	DPR8EA-9	4929	0,9	DPR8EVX-9	2872	221	DPR8EIX-9	2202
Thruxton 900	865	04 -	DPR8EA-9	4929	0,9	DPR8EVX-9	2872	221	DPR8EIX-9	2202
Adventurer	885	96 -	DPR8EA-9	4929	0,9	DPR8EVX-9	2872	221	DPR8EIX-9	2202

					Order No.		Platin 	Order No.	Quick-No.	Iridium 	Order No.
TRIUMPH											
Daytona 900	885	93 - 96	DPR8EA-9	4929	0,9	DPR8EVX-9	2872	221	DPR8EIX-9	2202	
Legend TT	885	98 -	DPR9EA-9	5329	0,9	DPR9EVX-9	3854	222	DPR9EIX-9	5545	
Daytona Super III	885	94 -	DPR8EA-9	4929	0,9	DPR8EVX-9	2872	221	DPR8EIX-9	2202	
Speed Triple	885	94 - 96	DPR8EA-9	4929	0,9	DPR8EVX-9	2872	221	DPR8EIX-9	2202	
Speed Triple T509	885	97 -	DPR8EA-9	4929	0,9	DPR8EVX-9	2872	221	DPR8EIX-9	2202	
Sport	885	98 -	DPR8EA-9	4929	0,9	DPR8EVX-9	2872	221	DPR8EIX-9	2202	
Sport Sprint 900	885	97 -	DPR8EA-9	4929	0,9	DPR8EVX-9	2872	221	DPR8EIX-9	2202	
Sprint	885	95 -	DPR8EA-9	4929	0,9	DPR8EVX-9	2872	221	DPR8EIX-9	2202	
Sprint 900	885	93 -	DPR8EA-9	4929	0,9	DPR8EVX-9	2872	221	DPR8EIX-9	2202	
Sprint Executive	885	98 -	DPR8EA-9	4929	0,9	DPR8EVX-9	2872	221	DPR8EIX-9	2202	
Sprint ST	885	99 -	DPR8EA-9	4929	0,9	DPR8EVX-9	2872	221	DPR8EIX-9	2202	
Thunderbird (T309RT)	885	95 -	DPR8EA-9	4929	0,9	DPR8EVX-9	2872	221	DPR8EIX-9	2202	
Thunderbird Sport	885	98 - 00	DPR8EA-9	4929	0,9	DPR8EVX-9	2872	221	DPR8EIX-9	2202	
Tiger 900 T400	885	93 - 98	DPR8EA-9	4929	0,9	DPR8EVX-9	2872	221	DPR8EIX-9	2202	
Tiger	885	99 -	DPR8EA-9	4929	0,9	DPR8EVX-9	2872	221	DPR8EIX-9	2202	
Trident 900	885	91 -	DPR8EA-9	4929	0,9	DPR8EVX-9	2872	221	DPR8EIX-9	2202	
Trophy 900	885	96 -	DPR8EA-9	4929	0,9	DPR8EVX-9	2872	221	DPR8EIX-9	2202	
Trophy 900	885	91 - 95	DPR8EA-9	4929	0,9	DPR8EVX-9	2872	221	DPR8EIX-9	2202	
Daytona 955i 72Kw	955	99 - 00	DPR8EA-9	4929	0,9	DPR8EVX-9	2872	221	DPR8EIX-9	2202	
Daytona 955i 94Kw	955	99 - 01	DPR8EA-9	4929	0,9	DPR8EVX-9	2872	221	DPR8EIX-9	2202	
Daytona 955i (595N)	955	02 -	CR9EK	4548	0,6				230	CR9EIX	3521
Daytona Centennial Edition (595N)	955	02 -	CR9EK	4548	0,6				230	CR9EIX	3521
Speed Triple (595N)	955	02 -	CR9EK	4548	0,6				230	CR9EIX	3521
Sprint RS (695AC)	955	02 -	CR9EK	4548	0,6				230	CR9EIX	3521
Sprint ST (695AB)	955	02 -	CR9EK	4548	0,6				230	CR9EIX	3521
Tiger 955i 72Kw (709EN)	955	01 -	DPR8EA-9	4929	0,9	DPR8EVX-9	2872	221	DPR8EIX-9	2202	
Daytona T595	956	97 -	DPR8EA-9	4929	0,9	DPR8EVX-9	2872	221	DPR8EIX-9	2202	
Speed Triple	956	99 - 01	DPR8EA-9	4929	0,9	DPR8EVX-9	2872	221	DPR8EIX-9	2202	
Sprint ST	956	99 - 01	DPR8EA-9	4929	0,9	DPR8EVX-9	2872	221	DPR8EIX-9	2202	
Daytona 1000	1000	91 - 92	DPR8EA-9	4929	0,9	DPR8EVX-9	2872	221	DPR8EIX-9	2202	
Speed Triple 1050	1050	05 -	DPR8EA-9	4929	0,9	DPR8EVX-9	2872	221	DPR8EIX-9	2202	
Sprint ST	1050	05 -	DPR8EA-9	4929	0,9	DPR8EVX-9	2872	221	DPR8EIX-9	2202	
Trophy 1200 (T300E)	1180	96 -	DPR8EA-9	4929	0,9	DPR8EVX-9	2872	221	DPR8EIX-9	2202	
Trophy 1200	1180	91 - 95	DPR8EA-9	4929	0,9	DPR8EVX-9	2872	221	DPR8EIX-9	2202	
Daytona 1200	1200	93 -	DPR8EA-9	4929	0,9	DPR8EVX-9	2872	221	DPR8EIX-9	2202	
Rocket III	2300	05.04 -	DPR8EA-9	4929	0,9	DPR8EVX-9	2872	221	DPR8EIX-9	2202	
UNISOM											
Desert-Cat 50 (ATV)	50	04 -	BR8HS	4322	0,6	BR8HVX	6265	212	BR8HIX	7001	
Desert-Cat 90 (ATV)	90	04 -	BR8HS	4322	0,6	BR8HVX	6265	212	BR8HIX	7001	
URAL											
Deco Cruiser	648	98 -	BP4HS	3611	0,6						
Italia Cruiser	648	98 -	BP4HS	3611	0,6						
Solo Cruiser	648	98 -	BP4HS	3611	0,6						
Sportsman Classic	648	97 -	BP4HS	3611	0,6						
Tourist Classic	648	97 -	BP4HS	3611	0,6						
IMZ-10	650		BP4HS	3611	0,6						
IMZ-40	650		BP4HS	3611	0,6						
IMZ-50	650		BP4HS	3611	0,6						
Solo Single	650	94 - 96	BP4HS	3611	0,6						
Sportsman	650	94 - 96	BP4HS	3611	0,6						

					Order No.		Platin 	Order No.	Quick-No.	Iridium 	Order No.
URAL											
Tourist Sidecar	650	94 - 96	BP4HS	3611	0,6						
Ural M3-8.103 23,6kW	650		BP5HS	4111	0,5						
Ural M3-8.123 26,5kW	650		BP6ES	7811	0,7	BP6EVX	5832			BPR6EIX	6637
Tourist	750		B7HS	5110	0,5	B7HVX	7836	204		BR7HIX	7067
URAL AMERICA											
Bavarian Classic	650	99 -			0,7	BP8HVX	2855				
Deco Classic	650	97 - 98	BP7HS	5111	0,7	BP7HVX	7468			BPR7HIX	5944
Deco Classic	650	99 -			0,7	BP8HVX	2855				
Deco Cruiser	650	98 -	BP7HS	5111	0,7	BP7HVX	7468			BPR7HIX	5944
Italia Cruiser	650	94 - 97	BP7HS	5111	0,7	BP7HVX	7468			BPR7HIX	5944
Italia Cruiser II	650	98 -	BP7HS	5111	0,7	BP7HVX	7468			BPR7HIX	5944
Patrol Classic	650	99 -			0,7	BP8HVX	2855				
Solo Classic	650	99 -			0,7	BP8HVX	2855				
Solo Cruiser	650	98 -	BP7HS	5111	0,7	BP7HVX	7468			BPR7HIX	5944
Solo Single	650	94 - 97	BP7HS	5111	0,7	BP7HVX	7468			BPR7HIX	5944
Sportsman	650	94 - 96	BP7HS	5111	0,7	BP7HVX	7468			BPR7HIX	5944
Sportsman Classic	650	97 - 98	BP7HS	5111	0,7	BP7HVX	7468			BPR7HIX	5944
Tourist Classic	650	99 -			0,7	BP8HVX	2855				
Tourist Classic	650	97 - 98	BP7HS	5111	0,7	BP7HVX	7468			BPR7HIX	5944
Tourist Sidecar	650	94 - 97	BP7HS	5111	0,7	BP7HVX	7468			BPR7HIX	5944
VALENTI											
CR 80W Cross (Yamaha/Valent)	80				0,5	B10EGV	5927				
VELOSOLEX											
2200	50		B4H	4110	0,5						
3300 /3800	50		B4H	4110	0,5						
5000	50		B4H	4110	0,5						
6000	50		B4H	4110	0,5						
8000 / 8000 GS Ténor	50		B6HS	4510	0,6	B6HVX	7435	203		BR6HIX	3419
GL Ténor	50		B6HS	4510	0,6	B6HVX	7435	203		BR6HIX	3419
GR Ténor	50		B6HS	4510	0,6	B6HVX	7435	203		BR6HIX	3419
L / R / S Ténor	50		B6ES	7310	0,7	B6EVX	5136				
Micron	50		B4H	4110	0,5						
Pli-solex	50		B4H	4110	0,5						
VERTEMATI											
E 450	503		CR9EK	4548	0,7			230		CR9EIX	3521
E 450 E	503		CR9EK	4548	0,7			230		CR9EIX	3521
E 501 E	503		CR9EK	4548	0,7			230		CR9EIX	3521
E 501	503		CR9EK	4548	0,7			230		CR9EIX	3521
E 570	503		CR9EK	4548	0,7			230		CR9EIX	3521
E 570 E	503		CR9EK	4548	0,7			230		CR9EIX	3521
VOR											
EN Enduro	400	00 -	CR8EK	3478	0,6						
ENE	400	04 -	CR8EK	3478	0,6						
EN-MAR	400	04 -	CR8EK	3478	0,6						
MX Cross	400	00 -	CR8EK	3478	0,6						
SM Super Moto	400	00 -	CR8EK	3478	0,6						
SM Super Moto Competition	400	00 -	CR8EK	3478	0,6						

					Order No.		Gold-Palladium	Platin 	Order No.	Quick-No.	Iridium 	Order No.
VOR												
EN Enduro	503	99 -	CR8EK	3478	0,6							
MX Cross	503	99 -	CR8EK	3478	0,6							
SM Super Moto	503	99 -	CR8EK	3478	0,6							
SM Super Moto Competition	503	99 -	CR8EK	3478	0,6							
ENE	530	04 -	CR8EK	3478	0,6							
EN-MAR	530	04 -	CR8EK	3478	0,6							
Super Motard Com.	530	00 -	CR8EK	3478	0,6							
VOXAN												
Roadster V 1000	1000	99 -			0,8	BCPR8EVX-11		5186				
Cafe Racer V 1000	1000	99 -			0,8	BCPR8EVX-11		5186				
XING FU												
XF Trail 150 (ATV)	150	05 -	C7HSA	4629	0,6	C7HVX		4533		CR7HIX		7544
XF Trail 250 (ATV)	250	05 -	C7HSA	4629	0,6	C7HVX		4533		CR7HIX		7544
YAMAHA												
Golf Car G2A/G9A	92		B5ES	6410	0,7							
CA 50 (14T)	50	83 - 87	BPR6HS	7022	0,7	BPR6HVX	2740	214	BPR6HIX			4085
CE 50 E	50		BP6HS-10	6326	1,0							
CH 50	50		BPR7HS	6422	0,7	BPR7HVX	2938	215	BPR7HIX			5944
CR 50 Z/SS	50	93 -	BP7HS-10	7829	1,0							
CV 50	50		BPR6HS	7022	0,7	BPR6HVX	2740	214	BPR6HIX			4085
CW 50	50	91 - 93	BR7HS	4122	0,8					211	BR7HIX	7067
CW 50 (4BX)	50	94 -	BPR7HS	6422	0,7	BPR7HVX	2938	215	BPR7HIX			5944
CY 50	50	94 -	BP7HS	5111	0,7	BP7HVX	7468		BPR7HIX			5944
CY 50 E	50	93 -	BP7HS	5111	0,7	BP7HVX	7468		BPR7HIX			5944
CY 50 F	50	94 -	BPR7HS	6422	0,7	BPR7HVX	2938	215	BPR7HIX			5944
DT 50	50		B7HS	5110	0,8	B7HVX	7836	204	BR7HIX			7067
DT 50 / supermotard	50	03 -	BR9ES	5722	0,8	BR9EVX	1265	208	BR9EIX			3981
DT 50 A (F)	50		BR6HS	3922	0,7				209	BR6HIX		3419
DT 50 E	50	93 -	BR8ES	5422	0,7	BR8EVX	1262	207	BR8EIX			5044
DT 50 F	50	94 -	BR8ES	5422	0,8	BR8EVX	1262	207	BR8EIX			5044
DT 50 LC (3UN3/4/5/6/7)	50	93 -	BR8ES	5422	0,7	BR8EVX	1262	207	BR8EIX			5044
DT 50 M (D)	50	86 -	BR7HS	4122	0,7				211	BR7HIX		7067
DT 50 M (S)	50	86 -	BR6HS	3922	0,7				209	BR6HIX		3419
DT 50 M (2M4)	50	78 - 81	B6HS	4510	0,7	B6HVX	7435	203	BR6HIX			3419
DT 50 M (A) (B)	50	86 -	B8HS	5510	0,7	B8HVX	2634	205	BR8HIX			7001
DT 50 M (NL)	50	86 -	B6HS	4510	0,7	B6HVX	7435	203	BR6HIX			3419
DT 50 MX (1NN)	50	01.86 -12.89	BR6HS	3922	0,7				209	BR6HIX		3419
DT 50 MX (4ET1)	50	92 -	B6HS	4510	0,7	B6HVX	7435	203	BR6HIX			3419
DT 50 MX (4ER1)	50	92 -	BR7HS	4122	0,7				211	BR7HIX		7067
DT 50 MX (3TG2)	50	92 -	BR6HS	3922	0,7				209	BR6HIX		3419
DT 50 R (3MN2)(3MN3)(3HL3)(4CT2)(4CT4)(4CT6)	50	91 -	BR7HS	4122	0,7				211	BR7HIX		7067
DT 50 R (5EC1)(5VB2)(5BK4)(5BK3)(5VB1)	50	97 -	CR8E	1275	0,7	CR8EVX	6487	226	CR8EIX			4218
DT 50 R (5BK1)(5BL1)	50	97 -	BR8ES	5422	0,8	BR8EVX	1262	207	BR8EIX			5044
DT 50 R (3MP2)(3MS2)(3MR2)(4AD2)(4JU1)	50	91 -	BR6HS	3922	0,7				209	BR6HIX		3419
DX 50 R (5BK2)	50	97 -	BR8ES	5422	0,8	BR8EVX	1262	207	BR8EIX			5044
DX 50 S (4CT3)(4CT5)(4CT7)	50	92 -	BR7HS	4122	0,7				211	BR7HIX		7067

				Order No.		Gold-Palladium		Platin	Order No.		Quick-No.	Iridium		Order No.
YAMAHA														
ES 50	50		B8HS	5510	0,7	B8HVX	2634	205	BR8HIX	7001				
Fizz (4RC)	50	95 -	BR8HS	4322	0,7	BR8HVX	6265	212	BR8HIX	7001				
FS 1 DX (3F2)	50	79 - 80	BR6HS	3922	0,7			209	BR6HIX	3419				
FS 1 E	50		B7HS	5110	0,6	B7HVX	7836	204	BR7HIX	7067				
FS 3 M	50		B8HS	5510	0,7	B8HVX	2634	205	BR8HIX	7001				
GT 50 B	50		B7HS	5110	0,7	B7HVX	7836	204	BR7HIX	7067				
GT 50 D (FT1)	50	73 - 75	B7HS	5110	0,7	B7HVX	7836	204	BR7HIX	7067				
Jog 50	50	90 -	BPR6HS	7022	0,7	BPR6HVX	2740	214	BPR6HIX	4085				
LB 2	50		B7HS	5110	0,7	B7HVX	7836	204	BR7HIX	7067				
LB 2 80	50	81 -	BP6HS	4511	0,7	BP6HVX	4635		BPR6HIX	4085				
LB 2 80	50	- 80	B6HS	4510	0,7	B6HVX	7435	203	BR6HIX	3419				
LB 2 M	50	81 -	BP6HS	4511	0,7	BP6HVX	4635		BPR6HIX	4085				
LB 2 M (551)	50	75 - 80	B6HS	4510	0,7	B6HVX	7435	203	BR6HIX	3419				
LB 3 80	50		B6HS	4510	0,7	B6HVX	7435	203	BR6HIX	3419				
LB 3 M	50		BP6HS	4511	0,7	BP6HVX	4635		BPR6HIX	4085				
LC 50	50		BP4HS	3611	0,7									
LC 50 H	50		BP4HS	3611	0,7									
LC 50 M	50		BP4HS	3611	0,7									
MA 50	50		BP4HS	3611	0,7									
MA 50 M	50		BP4HS	3611	0,7									
MBK Magnum	50	90 -	B8ES	2411	0,6	B8EVX	7051	201	BR8EIX	5044				
MR 50	50		B7HS	5110	0,7	B7HVX	7836	204	BR7HIX	7067				
MR 50 H	50		B7HS	5110	0,7	B7HVX	7836	204	BR7HIX	7067				
PW 50 (3PT)	50	01.87 -	BP4HS	3611	0,6									
PW 50 E	50	93 -	BPR4HS	7823	0,8									
PW 50 H / F	50		BP4HS	3611	0,7									
QT 50	50		BP4HS	3611	0,7									
QT 50 H	50		BP4HS	3611	0,7									
RD 50 DX (353)	50	73 - 75	B8HS	5510	0,7	B8HVX	2634	205	BR8HIX	7001				
RD 50 H	50		B7HS	5110	0,7	B7HVX	7836	204	BR7HIX	7067				
RD 50 MX (2E0)	50	77 - 81	B6HS	4510	0,7	B6HVX	7435	203	BR6HIX	3419				
SA 50	50		BP4HS	3611	0,7									
SA 50 H	50		BP4HS	3611	0,7									
SA 50 M	50		BP4HS	3611	0,7									
SG 50 (34N)	50	84 - 85	BPR6HS	7022	0,7	BPR6HVX	2740	214	BPR6HIX	4085				
SH 50 / F	50		BPR6HS-10	2633	1,0									
SH 50 E / ED / MF	50	93 -	BP6HS-10	6326	1,0									
T 50	50		C6HSA	3228	0,7				CR6HIX	7274				
TY 50 M (1G3)	50	77 - 80	B6HS	4510	0,7	B6HVX	7435	203	BR6HIX	3419				
TZR 50	50	03 -	BR9ES	5722	0,8	BR9EVX	1265	208	BR9EIX	3981				
V 50	50		B6HS	4510	0,6	B6HVX	7435	203	BR6HIX	3419				
V 50 D	50	93 -	B7HS	5110	0,7	B7HVX	7836	204	BR7HIX	7067				
V 50 E	50		B7HS	5110	0,7	B7HVX	7836	204	BR7HIX	7067				
V 50 M	50	- 80	B6HS	4510	0,7	B6HVX	7435	203	BR6HIX	3419				
V 50 M	50	81 - 83	BP6HS	4511	0,7	BP6HVX	4635		BPR6HIX	4085				
V 50 M	50	84 -	BR6ES	4922	0,8									
YA 50 (5AK)	50	97 -	BR7HS	4122	0,7			211	BR7HIX	7067				
YB 50 S	50		B7HS	5110	0,7	B7HVX	7836	204	BR7HIX	7067				
YE 50	50	93 -	BR7HS	4122	0,7			211	BR7HIX	7067				
YMF 50 S (ATV)	50	04 -	CR7HS	7223	0,7				CR7HIX	7544				
YZ 50	50		B9ES	2611	0,8	B9EVX	7254	202	BR9EIX	3981				
YZ 50 H	50		B9ES	2611	0,8	B9EVX	7254	202	BR9EIX	3981				

					Order No.		Platin 	Order No.	Quick-No. 	Iridium 	Order No.
YAMAHA											
RD 60 B	60		B7HS	5110	0,7	B7HVX	7836	204	BR7HIX		7067
YB 60	60		B7HS	5110	0,7	B7HVX	7836	204	BR7HIX		7067
YF 60 (1HN) (MOTO4 ATV)	60	87 - 88	BPR6HS	7022	0,7	BPR6HVX	2740	214	BPR6HIX		4085
YZ 60 H	60		B8ES	2411	0,8	B8EVX	7051	201	BR8EIX		5044
CW 65	65	94 -	BR7HS	4122	0,7				BR7HIX		7067
Active 80	80	90 -	BPR7HS	6422	0,7	BPR7HVX	2938	215	BPR7HIX		5944
CH 80	80		BR7HS	4122	0,7				BR7HIX		7067
CV 80	80		BPR7HS	6422	0,7	BPR7HVX	2938	215	BPR7HIX		5944
DT 80 LC-I (37A)	80	83 - 86	BR8ES	5422	0,8	BR8EVX	1262	207	BR8EIX		5044
DT 80 LC-II (53V)	80	84 -	BR9ES	5722	0,8	BR9EVX	1265	208	BR9EIX		3981
DT 80 MX (5J1)	80	81 - 84	B8HS	5510	0,7	B8HVX	2634	205	BR8HIX		7001
DT 80 MX-S (5T8)	80	83 - 86	BR8HS	4322	0,7	BR8HVX	6265	212	BR8HIX		7001
FS 80	80		B7HS	5110	0,7	B7HVX	7836	204	BR7HIX		7067
FS 80 SE (5A7)	80	81 - 82	B7HS	5110	0,7	B7HVX	7836	204	BR7HIX		7067
GT 80 (477)	80	74 - 75	B7HS	5110	0,7	B7HVX	7836	204	BR7HIX		7067
GT 80 D	80		B7HS	5110	0,7	B7HVX	7836	204	BR7HIX		7067
GT 80 E	80		B7HS	5110	0,7	B7HVX	7836	204	BR7HIX		7067
LB 80	80		BP6HS	4511	0,7	BP6HVX	4635		BPR6HIX		4085
LB 80 2A	80		B6HS	4510	0,7	B6HVX	7435	203	BR6HIX		3419
LB 80 2AC	80		B6HS	4510	0,7	B6HVX	7435	203	BR6HIX		3419
LB 80 2AD	80		B6HS	4510	0,7	B6HVX	7435	203	BR6HIX		3419
LB 80 2H	80		B6HS	4510	0,7	B6HVX	7435	203	BR6HIX		3419
LB 80 2HD	80		B7HS	5110	0,7	B7HVX	7836	204	BR7HIX		7067
LB 80 3 (1M9)	80	78 - 79	B6HS	4510	0,7	B6HVX	7435	203	BR6HIX		3419
LB 80 3D	80		B6HS	4510	0,7	B6HVX	7435	203	BR6HIX		3419
MX 80	80		B7HS	5110	0,7	B7HVX	7836	204	BR7HIX		7067
MX 80 H	80		B7HS	5110	0,7	B7HVX	7836	204	BR7HIX		7067
PW 80 (21W)	80	83 - 90	BPR6HS	7022	0,7	BPR6HVX	2740	214	BPR6HIX		4085
PW 80 E / F (4BC)	80	93 -	BP6HS	4511	0,7	BP6HVX	4635		BPR6HIX		4085
RD 80 LC-II (30W)	80	83 - 87	BR8ES	5422	0,8	BR8EVX	1262	207	BR8EIX		5044
RD 80 MX (5G1)	80	81 - 82	B8HS	5510	0,7	B8HVX	2634	205	BR8HIX		7001
RX 80 SE (12N)	80	82 - 83	B8HS	5510	0,7	B8HVX	2634	205	BR8HIX		7001
T 80	80		CR7HS	7223	0,7				CR7HIX		7544
TY 80	80		B7HS	5110	0,7	B7HVX	7836	204	BR7HIX		7067
V 80	80		BP6HS	4511	0,7	BP6HVX	4635		BPR6HIX		4085
V 80 H / D	80		BP6HS	4511	0,7	BP6HVX	4635		BPR6HIX		4085
Y 80	80		BP6HS	4511	0,7	BP6HVX	4635		BPR6HIX		4085
Y 80 E	80		BP6HS	4511	0,7	BP6HVX	4635		BPR6HIX		4085
YB 80	80		B7HS	5110	0,7	B7HVX	7836	204	BR7HIX		7067
YE 80 (4MU)	80	94 -	BR7HS	4122	0,7			211	BR7HIX		7067
YFM 80 (MOTO4 ATV)	80		CR7HS	7223	0,7				CR7HIX		7544
YFM 80 W Badger (ATV)	80	02 -	CR7HS	7223	0,7				CR7HIX		7544
YFM 80 W Raptor (ATV)	80	02 -	CR7HS	7223	0,7				CR7HIX		7544
YFM 80 E / F (MOTO4 ATV)	80	93 -	C7HSA	4629	0,7	C7HVX	4533		CR7HIX		7544
YZ 80	80	84 - 85	B9EG	3530	0,6	B9EGV	5827		BR9EIX		3981
YZ 80 (4GT)	80	95 -	B10EG	3630	0,7	B10EGV	5927				
YZ 80 (1LR)	80	86 -	BR9EG	3230	0,6	BR9EVX	1265		BR9EIX		3981
YZ 80 B	80		B8HS	5510	0,7	B8HVX	2634	205	BR8HIX		7001
YZ 80 C	80		B8ES	2411	0,8	B8EVX	7051	201	BR8EIX		5044
YZ 80 D	80		B8ES	2411	0,8	B8EVX	7051	201	BR8EIX		5044
YZ 80 E	80	- 92	B8ES	2411	0,8	B8EVX	7051	201	BR8EIX		5044
YZ 80 E / F/LW(4LB)/ LWF	80	93 -	B10EG	3630	0,6	B10EGV	5927				



Order No.



Gold-Palladium

Platin



Order No.

Quick-No.







Iridium



Order No.

YAMAHA

YZ 80 H	80	- 83	B8ES	2411	0,8	B8EVX	7051	201	BR8EIX	5044
YZ 80 H.R.	80		B7HS	5110	0,7	B7HVX	7836	204	BR7HIX	7067
YZ 80 L.R.	80		B8ES	2411	0,8	B8EVX	7051	201	BR8EIX	5044
YA 90 E / F	90	93 -	BR7HS	4122	0,7			211	BR7HIX	7067
AG 100	100		B7HS	5110	0,7	B7HVX	7836	204	BR7HIX	7067
AG 100 H / E / F	100		B7ES	1111	0,8	B7EVX	6934			
DT 100	100		B7ES	1111	0,8	B7EVX	6934			
DT 100 B	100		B8HS	5510	0,7	B8HVX	2634	205	BR8HIX	7001
DT 100 C	100		B7ES	1111	0,8	B7EVX	6934			
DT 100 D	100		B8ES	2411	0,8	B8EVX	7051	201	BR8EIX	5044
DT 100 E	100		B8ES	2411	0,8	B8EVX	7051	201	BR8EIX	5044
DT 100 H	100		B8ES	2411	0,8	B8EVX	7051	201	BR8EIX	5044
DT 100 SD	100		B8ES	2411	0,8	B8EVX	7051	201	BR8EIX	5044
DT 100 X	100		B7ES	1111	0,8	B7EVX	6934			
DX 100	100		B7HS	5110	0,7	B7HVX	7836	204	BR7HIX	7067
DX 100 H	100		B7HS	5110	0,7	B7HVX	7836	204	BR7HIX	7067
MX 100	100	79 -	B7ES	1111	0,8	B7EVX	6934			
MX 100 B	100		B8ES	2411	0,8	B8EVX	7051		BR8EIX	5044
MX 100 H	100		B7ES	1111	0,8	B7EVX	6934			
RS 100 B	100		B8HS	5510	0,7	B8HVX	2634	205	BR8HIX	7001
RS 100 DX (1Y8)	100	76 - 81	B8HS	5510	0,7	B8HVX	2634	205	BR8HIX	7001
RS 100 P	100		BP6HS	4511	0,7	BP6HVX	4635		BPR6HIX	4085
RS 100 S	100		B8HS	5510	0,7	B8HVX	2634	205	BR8HIX	7001
RS 100 X	100		B8HS	5510	0,7	B8HVX	2634	205	BR8HIX	7001
RT 100 E / F	100	93 -	B7ES	1111	0,8	B7EVX	6934			
RX 100 12,7mm	100		B8HS	5510	0,7	B8HVX	2634	205	BR8HIX	7001
RX 100 19,0mm	100		B8ES	2411	0,8	B8EVX	7051	201	BR8EIX	5044
RXS 100	100		BR8HS	4322	0,7	BR8HVX	6265	212	BR8HIX	7001
RX-ZD	100	93 -	BP8ES	2912	0,8	BP8EVX	2671			
V 100/E/S/SH	100	93 -	BP7HS-10	7829	1,0					
YB 100	100	94 -	BP6HS	4511	0,7	BP6HVX	4635		BPR6HIX	4085
YB 100 M	100		B8HS	5510	0,7	B8HVX	2634	205	BR8HIX	7001
YB 100 P	100		B7HS	5110	0,7	B7HVX	7836	204	BR7HIX	7067
YZ 100	100	- 83	B10EG	3630	0,6	B10EGV	5927			
YZ 100 E	100		B10EG	3630	0,6	B10EGV	5927			
YZ 100 H	100		B10EG	3630	0,6	B10EGV	5927			
V 110 E	110	93 -	BP7HS-10	7829	1,0					
RX 115	115	93 -	BP8HS	2630	0,7				BPR8HIX	6742
V 120 JR / ZR	120	94 -	BP8ES	2912	0,8	BP8EVX	2671			
BL 125 (50W)	125	85 - 89	BPR8HS	3725	0,7				BPR8HIX	6742
DT 125	125	94 -	B8ES	2411	0,8	B8EVX	7051	201	BR8EIX	5044
DT 125 RE	125	04 -	BR8ES	5422	0,8	BR8EVX	1262	207	BR8EIX	5044
DT 125 E (1G0)	125	77 - 79	BR9ES	5722	0,8	BR9EVX	1265	208	BR9EIX	3981
DT 125 E (AT2)	125	73 - 76	B8ES	2411	0,8	B8EVX	7051	201	BR8EIX	5044
DT 125 ED	125		B8ES	2411	0,8	B8EVX	7051	201	BR8EIX	5044
DT 125 F	125		B8ES	2411	0,8	B8EVX	7051	201	BR8EIX	5044
DT 125 H	125		B8ES	2411	0,8	B8EVX	7051	201	BR8EIX	5044
DT 125 LC	125	86 -	BR9ES	5722	0,8	BR9EVX	1265	208	BR9EIX	3981
DT 125 LC (10V)	125	82 - 85	BR8ES	5422	0,8	BR8EVX	1262	207	BR8EIX	5044
DT 125 MX	125		B8ES	2411	0,8	B8EVX	7051	201	BR8EIX	5044
DT 125 R (4BL) / RE (3RM)	125	91 -	BR9ES	5722	0,8	BR9EVX	1265	208	BR9EIX	3981
DT 125 Tenere (I)	125		B9ES	2611	0,8	B9EVX	7254	202	BR9EIX	3981

					Order No.		Gold-Palladium	Platin 	Order No.	Quick-No.	Iridium 	Order No.
YAMAHA												
DT 125 X	125	05 -	BR8ES	5422	0,5	BR8EVX	1262	207	BR8EIX	5044		
IT 125	125		B9EG	3530	0,6	B9EGV	5827		BR9EIX	3981		
IT 125 H	125		B9EG	3530	0,6	B9EGV	5827		BR9EIX	3981		
MX 125	125				0,6	B9EVX	7254		BR9EIX	3981		
R 125 SE	125		BP7HS	5111	0,7	BP7HVX	7468		BPR7HIX	5944		
RD 125 12,7mm	125		B8HS	5510	0,7	B8HVX	2634	205	BR8HIX	7001		
RD 125 19,0mm	125		B8ES	2411	0,8	B8EVX	7051	201	BR8EIX	5044		
RD 125 C	125		B8ES	2411	0,8	B8EVX	7051	201	BR8EIX	5044		
RD 125 C-DX	125		B8ES	2411	0,8	B8EVX	7051	201	BR8EIX	5044		
RD 125 D	125		B8ES	2411	0,8	B8EVX	7051	201	BR8EIX	5044		
RD 125 D-DX (AS3)	125	73 - 75	B8HS	5510	0,7	B8HVX	2634	205	BR8HIX	7001		
RD 125 LC	125	84 -	BR8ES	5422	0,8	BR8EVX	1262	207	BR8EIX	5044		
RD 125 LC (10W)	125	82 - 83	BR9ES	5722	0,8	BR9EVX	1265	208	BR9EIX	3981		
RS 125 DX	125		B8HS	5510	0,7	B8HVX	2634	205	BR8HIX	7001		
RS 125 E	125		B7HS	5110	0,7	B7HVX	7836	204	BR7HIX	7067		
RS 125 P	125		BP7HS	5111	0,7	BP7HVX	7468		BPR7HIX	5944		
RS 125 Z	125		B8HS	5510	0,7	B8HVX	2634	205	BR8HIX	7001		
RX 125 12,7mm	125		B8HS	5510	0,7	B8HVX	2634	205	BR8HIX	7001		
RX 125 19,0mm	125		B8ES	2411	0,8	B8EVX	7051	201	BR8EIX	5044		
RX 125 H	125		B7HS	5110	0,7	B7HVX	7836	204	BR7HIX	7067		
SR 125	125		D8EA	2120	0,7	D8EVX	2850	216	DR8EIX	6681		
SR 125 (10F)	125	97 -	DR8EA	7162	0,7	DR8EVX	6354		DR8EIX	6681		
SR 125 Z	125	93 -	DR8EA	7162	0,7	DR8EVX	6354		DR8EIX	6681		
TA 125 (400)	125	73 - 75	B10EG	3630	0,6	B10EGV	5927					
TA 125 A	125		B10EG	3630	0,6	B10EGV	5927					
TDR 125 (4GW)	125	92 -	BR9ES	5722	0,9	BR9EVX	1265	208	BR9EIX	3981		
TDR 125 (5AN)	125	97 -	BR8ES	5422	0,8	BR8EVX	1262	207	BR8EIX	5044		
TW 125 (DE011/012)	125	99 -	DR8EA	7162	0,6	DR8EVX	6354		DR8EIX	6681		
TY 125 (1K6)	125	77 - 81	B7ES	1111	0,7	B7EVX	6934					
TZ 125 (4JT)	125	95 -	R7376-10	4457	0,6							
TZ 125 (3V3)	125	80 -			0,6	B10EVX	7335		BR10EIX	6801		
TZ 125 / F	125	94 -	R7376-10	4457	0,6							
TZ 125 H	125	-			0,6	B10EVX	7335		BR10EIX	6801		
TZR 125	125	- 92	BR9ES	5722	0,8	BR9EVX	1265	208	BR9EIX	3981		
TZR 125	125	93 -	BR9ECM	3252	0,8	BR9ECMVX	2434					
XT 125	125		D8EA	2120	0,7	D8EVX	2850	216	DR8EIX	6681		
XT 125 R	125	05 -	CR7HSA	4549	0,8				CR7HIX	7544		
XT 125 X	125	05 -	CR7HSA	4549	0,8				CR7HIX	7544		
XV 125 (5AJ)	125	97 -	CR6HSA	2983	0,6				CR6HIX	7274		
XV 125 S Virago(5AJ)	125	99 -	CR6HSA	2983	0,6				CR6HIX	7274		
XVS 125 (VP05)	125	00 -	CR7HSA	4549	0,6				CR7HIX	7544		
YB 125	125		B7HS	5110	0,7	B7HVX	7836	204	BR7HIX	7067		
YBR 125	125	05 -	CR6HSA	2983	0,7				CR6HIX	7274		
YFA 1 Breeze (MOTO4 ATV)	125	89 - 04	CR7HS	7223	0,7				CR7HIX	7544		
YFA 1 F (MOTO4 ATV)	125	94 -	C7HSA	4629	0,7	C7HVX	4533		CR7HIX	7544		
YS 125	125				0,6	B9EVX	7254		BR9EIX	3981		
YT 125 (MOTO4 ATV)	125		BP6ES	7811	0,8	BP6EVX	5832		BPR6EIX	6637		
YT 125 CH (MOTO4 ATV)	125		BP6ES	7811	0,8	BP6EVX	5832		BPR6EIX	6637		
YT 125 H (MOTO4 ATV)	125		BP6ES	7811	0,8	BP6EVX	5832		BPR6EIX	6637		
YZ 125	125		B9EG	3530	0,6	B9EGV	5827		BR9EIX	3981		
YZ 125 B	125		B9EG	3530	0,6	B9EGV	5827		BR9EIX	3981		
YZ 125 C	125		B9EG	3530	0,6	B9EGV	5827		BR9EIX	3981		



Order No.



Gold-Palladium

Platin



Order No.

Quick-No.







Iridium











Order No.

YAMAHA

YZ 125 E	125		B9EG	3530	0,6	B9EGV	5827		BR9EIX	3981
YZ 125 E / E1 / F	125	93 -	BR9EG	3230	0,6	BR9EVX	1265		BR9EIX	3981
YZ 125 H	125		B9EG	3530	0,6	B9EGV	5827		BR9EIX	3981
YZ 125 X	125		B9EG	3530	0,6	B9EGV	5827		BR9EIX	3981
FZ 150	150	94 -	C7HSA	4629	0,7	C7HVX	4533		CR7HIX	7544
FZR 150	150	94 -	C7HSA	4629	0,7	C7HVX	4533		CR7HIX	7544
RX 150	150	93 -	BP8ES	2912	0,8	BP8EVX	2671			
SR 150	150	93 -	D8EA	2120	0,7	D8EVX	2850	216	DR8EIX	6681
DT 165 R	165	91 -	BR8ES	5422	0,8	BR8EVX	1262	207	BR8EIX	5044
AG 175	175		B8ES	2411	0,8	B8EVX	7051	201	BR8EIX	5044
AG 175 H	175		B7ES	1111	0,8	B7EVX	6934			
DT 175 (CT1)	175	74 - 75	B8ES	2411	0,8	B8EVX	7051	201	BR8EIX	5044
DT 175 E / F	175		B8ES	2411	0,8	B8EVX	7051	201	BR8EIX	5044
DT 175 H	175		B9ES	2611	0,8	B9EVX	7254	202	BR9EIX	3981
DT 175 MX (2K4)	175	09.78 - 12.81	B8ES	2411	0,8	B8EVX	7051	201	BR8EIX	5044
IT 175 (5V0)	175	83 - 84	B9EG	3530	0,6	B9EGV	5827		BR9EIX	3981
IT 175 E	175				0,6	B10EVX	7335		BR10EIX	6801
IT 175 H	175		B9EG	3530	0,6	B9EGV	5827		BR9EIX	3981
MX 175	175		B8ES	2411	0,8	B8EVX	7051	201	BR8EIX	5044
MX 175 B	175				0,6	B8EVX	7051		BR8EIX	5044
MX 175 H	175		B8ES	2411	0,8	B8EVX	7051	201	BR8EIX	5044
TY 175	175		B7ES	1111	0,8	B7EVX	6934			
TY 175 E	175		B7ES	1111	0,8	B7EVX	6934			
TY 175 J	175		B7ES	1111	0,8	B7EVX	6934			
YT 175 (MOTO4 ATV)	175		BP7ES	2412	0,8	BP7EVX	7270	206	BPR7EIX	4055
YZ 175	175				0,6	B10EVX	7335		BR10EIX	6801
RT 180 E	180	93 -	B8ES	2411	0,8	B8EVX	7051	201	BR8EIX	5044
XC 180 (32H)	180	83 - 84	DPR8EA-9	4929	0,9	DPR8EVX-9	2872	221	DPR8EIX-9	2202
SH 185 H	185		D7EA	7912	0,7	D7EVX	2734			
RS 195	195		B7ES	1111	0,8	B7EVX	6934			
AG 200 E / F	200	93 -	D8EA	2120	0,7	D8EVX	2850	216	DR8EIX	6681
BW 200	200		D8EA	2120	0,7	D8EVX	2850	216	DR8EIX	6681
DT 200 LC / RE / RF	200	93 -	BR9ES	5722	0,8	BR9EVX	1265	208	BR9EIX	3981
DT 200 R	200		BR9ES	5722	0,8	BR9EVX	1265	208	BR9EIX	3981
IT 200 S	200		BR9EG	3230	0,6	BR9EVX	1265		BR9EIX	3981
YFM 200 (MOTO4 ATV)	200	92 -	D7EA	7912	0,6	D7EVX	2734			
NR 200	200		B7ES	1111	0,8	B7EVX	6934			
RD 200 12,7mm	200		B7HS	5110	0,7	B7HVX	7836	204	BR7HIX	7067
RD 200 19,0mm (397)	200		B7ES	1111	0,7	B7EVX	6934			
RD 200 C	200		B8ES	2411	0,8	B8EVX	7051	201	BR8EIX	5044
RD 200 C-DX	200		B8ES	2411	0,8	B8EVX	7051	201	BR8EIX	5044
RD 200 D	200		B8ES	2411	0,8	B8EVX	7051	201	BR8EIX	5044
RD 200 D-DX (1E8)	200	77 - 80	B8ES	2411	0,8	B8EVX	7051	201	BR8EIX	5044
RS 200	200		B8ES	2411	0,8	B8EVX	7051	201	BR8EIX	5044
TW 200	200	01.87 -	DR8EA	7162	0,7	DR8EVX	6354		DR8EIX	6681
TW 200 E / EC / F	200	93 -	DR8EA	7162	0,7	DR8EVX	6354		DR8EIX	6681
TW 200 FC	200	94 -	D8EA	2120	0,7	D8EVX	2850	216	DR8EIX	6681
WR 200 R / RE / RF	200	93 -	BR9ES	5722	0,8	BR9EVX	1265	208	BR9EIX	3981
YFM 200 (52H) (MOTO4 ATV)	200	85 - 86	DR7ES	3123	0,7					
YFM 225 (2HT) (MOTO4 ATV)	200		DR7ES	3123	0,7					
YFM 225 (59V) (MOTO4 ATV)	200		DR7ES	3123	0,7					
YFS 200 Blaster (MOTO4 ATV)	200	90 - 04	BR8ES	5422	0,8	BR8EVX	1262	207	BR8EIX	5044

					Order No.		Gold-Palladium	Platin 	Order No.	Quick-No.	Iridium 	Order No.
YAMAHA												
YFS 200 E / F (MOTO4 ATV)	200	93 -	B8ES	2411	0,8	B8EVX		7051	201	BR8EIX		5044
YFM 225 59V/2HT (MOTO4 ATV)	225	92 -	DR7ES	3123	0,7							
TT 225 (MOTO4 ATV)	225		DR8ESL	2923	0,7	DR8EVX	6354	218	DR8EIX	6681		
XT 225 E / EC / F / FC	225	93 -	DR8EA	7162	0,7	DR8EVX	6354		DR8EIX	6681		
TDR 240	240		BR9ES	5722	0,8	BR9EVX	1265	208	BR9EIX	3981		
XV 240	240		CR6HS	7023	0,7				223	CR6HIX	7274	
DT 250 (512)	250	75 - 76	B8ES	2411	0,8	B8EVX	7051	201	BR8EIX	5044		
DT 250 E	250		B8ES	2411	0,8	B8EVX	7051	201	BR8EIX	5044		
DT 250 H	250		B8ES	2411	0,8	B8EVX	7051	201	BR8EIX	5044		
DT 250 MX (1R7)	250	77 - 81	B8ES	2411	0,8	B8EVX	7051	201	BR8EIX	5044		
IT 250 (45J)	250	85 -	B9EG	3530	0,6	B9EGV	5827		BR9EIX	3981		
IT 250 (4V5)	250	81 -	B8EG	3430	0,6	B8EGV	5627					
IT 250 J	250		B9EG	3530	0,6	B9EGV	5827		BR9EIX	3981		
IT 250 K	250		B9EG	3530	0,6	B9EGV	5827		BR9EIX	3981		
IT 250 N	250		BR9EG	3230	0,6	BR9EVX	1265		BR9EIX	3981		
MX 250	250				0,6	B8EVX	7051		BR8EIX	5044		
R1-Z	250	93 -	BR9ES	5722	0,8	BR9EVX	1265	208	BR9EIX	3981		
RD 250 (522)	250	75 -	B8ES	2411	0,8	B8EVX	7051	201	BR8EIX	5044		
RD 250 D	250		B8ES	2411	0,8	B8EVX	7051	201	BR8EIX	5044		
RD 250 LC (4L1)	250	80 - 83	B8ES	2411	0,8	B8EVX	7051	201	BR8EIX	5044		
SE 250 (I)	250		BPR7ES	2023	0,8	BPR7EVX	5565		BPR7EIX	4055		
SR 250 (I)	250		BPR7ES	2023	0,8	BPR7EVX	5565		BPR7EIX	4055		
SR 250 H / F	250		BP7ES	2412	0,8	BP7EVX	7270	206	BPR7EIX	4055		
SR 250 SE (3Y8)	250	80 - 82	BP7ES	2412	0,8	BP7EVX	7270	206	BPR7EIX	4055		
SR 250 TH	250		BP7ES	2412	0,8	BP7EVX	7270	206	BPR7EIX	4055		
TDR 250 (3CK)	250	88 - 89	BR9ES	5722	0,8	BR9EVX	1265	208	BR9EIX	3981		
TRD 250 (I)	250		BR9ES	5722	0,7	BR9EVX	1265	208	BR9EIX	3981		
TT 250	250		D8EA	2120	0,7	D8EVX	2850	216	DR8EIX	6681		
TT 250 R / RF	250	94 -	CR9E	6263	0,7	CR9EVX	5943	227	CR9EIX	3521		
TY 250 (38V)	250	84 - 87	BR6ES	4922	0,8							
TY 250 (3BA)	250	88 - 90	B7ES	1111	0,8	B7EVX	6934					
TY 250 (S16)	250	75 - 79	B7ES	1111	0,8	B7EVX	6934					
TY 250 Z (4GG)	250	94 - 96			0,6	BP6EVX	5832		BPR6EIX	6637		
TZ 250	250	- 83			0,6	B10EVX	7335		BR10EIX	6801		
TZ 250	250	84 -	B10EG	3630	0,5	B10EGV	5927					
TZ 250 (4DP)	250	95 -	R6179A-105P	2697	0,6							
TZ 250 / F	250	94 -	R6179A-105P	2697	0,6							
TZ 250 E	250	- 83			0,6	B10EVX	7335		BR10EIX	6801		
TZ 250 E/E1	250	93 -	R5184-105	3334	0,6							
TZ 250 H	250	- 83			0,6	B10EVX	7335		BR10EIX	6801		
TZR 250 " V2"	250	91 - 95	BR9ECM	3252	0,6	BR9ECMVX	2434					
TZR 250 (2MA)	250	87 - 89	BR9ES	5722	0,8	BR9EVX	1265	208	BR9EIX	3981		
TZR 250R/RS/RSP	250	93 -	BR9ECM	3252	0,8	BR9ECMVX	2434					
WR 250 F	250	03 -	CR8E	1275	0,7	CR8EVX	6487	226	CR8EIX	4218		
WR 250 F	250	01 -	CR8E	1275	0,7	CR8EVX	6487	226	CR8EIX	4218		
WR 250 Z / ZE / ZF (4JW)	250	93 -	B8EG	3430	0,6	B8EGV	5627					
XS 250 (1V5)	250	78 - 79	BP7ES	2412	0,8	BP7EVX	7270	206	BPR7EIX	4055		
XS 250 C	250		BP7ES	2412	0,8	BP7EVX	7270	206	BPR7EIX	4055		
XS 250 H	250		BP7ES	2412	0,8	BP7EVX	7270	206	BPR7EIX	4055		
XS 250 RH	250	- 83	BP7ES	2412	0,8	BP7EVX	7270	206	BPR7EIX	4055		
XS 250 SE	250		BP7ES	2412	0,8	BP7EVX	7270	206	BPR7EIX	4055		
XS 250 SH	250		BP7ES	2412	0,8	BP7EVX	7270	206	BPR7EIX	4055		

					Order No.		Platin 	Order No.	Quick-No. 	Iridium 	Order No.
YAMAHA											
XT 250 (3V3)	250	80 - 82	DR8ESL	2923	0,6	DR8EVX	6354	218	DR8EIX	6681	
XT 250 H	250	- 84	BP7ES	2412	0,8	BP7EVX	7270	206	BPR7EIX	4055	
XV 250	250	94 -	CR6HSA	2983	0,7				CR6HIX	7274	
XV 250 (3LS,3LW)	250	89 -	CR6HS	7023	0,7		223		CR6HIX	7274	
XV 250 F	250	94 -	C6HSA	3228	0,7				CR6HIX	7274	
XV 250 S (3LW)	250	95 -	CR6HS	7023	0,8		223		CR6HIX	7274	
XVS 250 (VG031)	250	01 -	CR6HS	7023	0,7		223		CR6HIX	7274	
YFB 250 / E / F / FWF (MOTO4 ATV)	250	93 -	D7EA	7912	0,7	D7EVX	2734				
YFB 250 / FW (MOTO4 ATV)	250	94 -	DR7EA	7839	0,7						
YFM 250 Timberwolf (MOTO4 ATV)	250		DR7EA	7839	0,7						
YFM 250 (3GH) (MOTO4 ATV)	250	90 -	DR7ES	3123	0,7						
YFM 250 Bruin (ATV)	250	05 -	DR7EA	7839	0,6						
YFM 250 X Bear Tracker (MOTO4 ATV)	250	99 - 04	DR7EA	7839	0,7						
YZ 250 (4MX)	250	95 -	B8EG	3430	0,7	B8EGV	5627				
YZ 250 (2VM,3JE,3SP,3XK)	250	88 - 91	B8EG	3430	0,6	B8EGV	5627				
YZ 250 (39X,56A,1LU,2HH)	250	84 - 87	B8EG	3430	0,6	B8EGV	5627				
YZ 250 (4DA,4EW)	250	92 -	B8EG	3430	0,6	B8EGV	5627				
YZ 250 (5X5,24Y)	250	82 - 83	B9EG	3530	0,6	B9EGV	5827		BR9EIX	3981	
YZ 250 F	250	94 -	B8EG	3430	0,6	B8EGV	5627				
YZ 250 F (CG10C)	250	01 -	CR8E	1275	0,7	CR8EVX	6487	226	CR8EIX	4218	
XVZ 13 (3JS)	300	89 - 92	DPR8EA-9	4929	0,9	DPR8EVX-9	2872	221	DPR8EIX-9	2202	
BW 350	350		DR8ESL	2923	0,9	DR8EVX	6354	218	DR8EIX	6681	
RD 350	350	87 -	BR9ES	5722	0,8	BR9EVX	1265	208	BR9EIX	3981	
RD 350 12,7mm	350		B8HS	5510	0,7	B8HVX	2634	205	BR8HIX	7001	
RD 350 19,0mm	350		B8ES	2411	0,8	B8EVX	7051	201	BR8EIX	5044	
RD 350 C	350		B8ES	2411	0,8	B8EVX	7051	201	BR8EIX	5044	
RD 350 H 12,7mm (351)	350	73 - 74	B8HS	5510	0,7	B8HVX	2634	205	BR8HIX	7001	
RD 350 H 19,0mm (521)	350	75 -	B8ES	2411	0,8	B8EVX	7051	201	BR8EIX	5044	
RD 350 J	350		B8ES	2411	0,8	B8EVX	7051	201	BR8EIX	5044	
RD 350 LC	350	- 85	BR8ES	5422	0,8	BR8EVX	1262	207	BR8EIX	5044	
RD 350 LC (1WX,1WW)	350	86 - 89	BR9ES	5722	0,8	BR9EVX	1265	208	BR9EIX	3981	
RD 350 LCF	350	86 -	BR9ES	5722	0,8	BR9EVX	1265	208	BR9EIX	3981	
TT 350 (1TJ)	350	86 - 89	D8EA	2120	0,7	D8EVX	2850	216	DR8EIX	6681	
TT 350 E / F	350	93 -	D8EA	2120	0,7	D8EVX	2850	216	DR8EIX	6681	
TZ 350 B	350		B10EG	3630	0,6	B10EGV	5927				
TZ 350 H	350		B10EG	3630	0,6	B10EGV	5927				
XT 350 (3YT)	350	91 -	DR8ESL	2923	0,6	DR8EVX	6354	218	DR8EIX	6681	
XT 350 (55V)	350	85 - 90	DR8ESL	2923	0,7	DR8EVX	6354	218	DR8EIX	6681	
XT 350 E / F	350	93 -	D8EA	2120	0,7	D8EVX	2850	216	DR8EIX	6681	
YFM 350 (3HN) (MOTO4 ATV)	350	89 -	DR8ESL	2923	0,6	DR8EVX	6354	218	DR8EIX	6681	
YFM 350 2HR/2HN (MOTO4 ATV)	350	92 -	DR8ESL	2923	0,6	DR8EVX	6354	218	DR8EIX	6681	
YFM 350 4x4 (3HN) (MOTO4 ATV)	350		DR8ESL	2923	0,7	DR8EVX	6354	218	DR8EIX	6681	
YFM 350 4x4 (2HR) (MOTO4 ATV)	350		DR8ESL	2923	0,7	DR8EVX	6354	218	DR8EIX	6681	
YFM 350 ERF / FWF / XF (MOTO4 ATV)	350	94 -	D8EA	2120	0,7	D8EVX	2850	216	DR8EIX	6681	
YFM 350 FW (MOTO4 ATV)	350	94 -	DR8EA	7162	0,7	DR8EVX	6354		DR8EIX	6681	
YFM 350 X Warrior (MOTO4 ATV)	350	97 - 04	DR8EA	7162	0,7	DR8EVX	6354		DR8EIX	6681	
YFZ 350 (MOTO4 ATV)	350	94 -	BR8ES	5422	0,8	BR8EVX	1262	207	BR8EIX	5044	
YFZ 350 Banshee (MOTO4 ATV)	350	86 - 04	BR8ES	5422	0,8	BR8EVX	1262	207	BR8EIX	5044	
YFZ 350 E / F (MOTO4 ATV)	350	93 -	B8ES	2411	0,8	B8EVX	7051	201	BR8EIX	5044	
DT 360 (RT2)	360	01.73 -12.75	B9ES	2611	0,8	B9EVX	7254	202	BR9EIX	3981	
MX 360	360				0,6	B8EVX	7051		BR8EIX	5044	
XS 360 (1V4)	360	01.77 -12.78	BP6ES	7811	0,8	BP6EVX	5832		BPR6EIX	6637	



Order No.



Gold-Palladium



Order No.









Iridium

















Order No.







YAMAHA

YZ 360	360				0,6	B8EVX	7051		BR8EIX	5044
DT 400 (513)	400	11.75 - 12.76	B8ES	2411	0,8	B8EVX	7051	201	BR8EIX	5044
DT 400 E	400		B9ES	2611	0,8	B9EVX	7254	202	BR9EIX	3981
DT 400 H	400		B8ES	2411	0,8	B8EVX	7051	201	BR8EIX	5044
DT 400 MX (1R6)	400	77 - 80	B8ES	2411	0,8	B8EVX	7051	201	BR8EIX	5044
FZR 400	400	04.87 -	CR8E	1275	0,7	CR8EVX	6487	226	CR8EIX	4218
IT 400	400		B8ES	2411	0,8	B8EVX	7051	201	BR8EIX	5044
IT 400 E	400				0,6	B8EVX	7051		BR8EIX	5044
MX 400	400				0,6	B8EVX	7051		BR8EIX	5044
RD 400 (1A3)	400	76 - 79	B8ES	2411	0,8	B8EVX	7051	201	BR8EIX	5044
RD 400 E	400		B8ES	2411	0,8	B8EVX	7051	201	BR8EIX	5044
SR 400	400		BP7ES	2412	0,8	BP7EVX	7270	206	BPR7EIX	4055
TT 400 C	400				0,6	B8EVX	7051		BR8EIX	5044
WR 400 F	400	98 -	CR8E	1275	0,7	CR8EVX	6487	226	CR8EIX	4218
XJ 400	400		D8EA	2120	0,7	D8EVX	2850	216	DR8EIX	6681
XS 400 (12E)	400	82 - 89	DR8ESL	2923	0,7	DR8EVX	6354	218	DR8EIX	6681
XS 400 (2A2)	400	78 - 82	BP7ES	2412	0,8	BP7EVX	7270	206	BPR7EIX	4055
XS 400 SE (465)	400	80 - 82	BP7ES	2412	0,8	BP7EVX	7270	206	BPR7EIX	4055
XT 400	400	84 -	DR7ES	3123	0,7					
XT 400	400	- 83	BP7ES	2412	0,8	BP7EVX	7270	206	BPR7EIX	4055
XV 400 SE	400		BPR7ES	2023	0,8	BPR7EVX	5565		BPR7EIX	4055
YFM 400 (MOTO4 ATV)	400	93 -	DR8ESL	2923	0,7	DR8EVX	6354	218	DR8EIX	6681
YFM 400 AN Kodiak (MOTO4 ATV)	400	03 - 04	DR8EA	7162	0,7	DR8EVX	6354		DR8EIX	6681
YFM 400 FW (MOTO4 ATV)	400	94 - 04	DR8EA	7162	0,7	DR8EVX	6354		DR8EIX	6681
YFM 400 FWF (MOTO4 ATV)	400	94 -	D8EA	2120	0,7	D8EVX	2850	216	DR8EIX	6681
YFM 400 FWA Kodiak (MOTO4 ATV)	400	00 - 04	DR8EA	7162	0,7	DR8EVX	6354		DR8EIX	6681
YFM 450 FWAN Kodiak (MOTO4 ATV)	400	03 - 04	DR8EA	7162	0,7	DR8EVX	6354		DR8EIX	6681
YP 400 Majesty	400	05 -	CR7E	4578	0,6		225		CR7EIX	7385
YZ 400	400				0,6	B8EVX	7051		BR8EIX	5044
YZ 400 C	400				0,6	B8EVX	7051		BR8EIX	5044
YZ 400 E	400				0,6	B8EVX	7051		BR8EIX	5044
YZ 400 F	400	12.97 -	CR8E	1275	0,7	CR8EVX	6487	226	CR8EIX	4218
IT 425	425		B8ES	2411	0,8	B8EVX	7051	201	BR8EIX	5044
WR 426 F (CJ02W)	426	01 -	CR8E	1275	0,7	CR8EVX	6487	226	CR8EIX	4218
YZF 426 F	426	01 -	CR8E	1275	0,6	CR8EVX	6487	226	CR8EIX	4218
WR 450 F	450	03 -	CR8E	1275	0,7	CR8EVX	6487	226	CR8EIX	4218
YZF 450 S (ATV)	450	04 -	CR8E	1275	0,7	CR8EVX	6487	226	CR8EIX	4218
YZ 450 F	450	03 -	CR8E	1275	0,7	CR8EVX	6487	226	CR8EIX	4218
IT 465 (4V6)	465	81 -	B8ES	2411	0,8	B8EVX	7051	201	BR8EIX	5044
IT 465 H	465		B8ES	2411	0,8	B8EVX	7051	201	BR8EIX	5044
YZ 465	465		B8ES	2411	0,8	B8EVX	7051	201	BR8EIX	5044
YZ 465 H	465		B8ES	2411	0,8	B8EVX	7051	201	BR8EIX	5044
IT 490 (29W)	490	83 - 85	BR8ES	5422	0,6	BR8EVX	1262	207	BR8EIX	5044
YZ 490	490		BR9EG	3230	0,6	BR9EVX	1265		BR9EIX	3981
IT 500	500		BP7ES	2412	0,7	BP7EVX	7270	206	BPR7EIX	4055
MX 500	500				0,6	B8EVX	7051		BR8EIX	5044
RD 500 LC (1GE)	500	85 - 86	BR9HS	4522	0,7					
RD 500 LC (47X)	500	- 84	BR9HS	4522	0,7					
SR 500 (3EB)	500	95 -	BPR7ES	2023	0,6	BPR7EVX	5565		BPR7EIX	4055
SR 500 (2J4,48T)	500	01.79 - 96	BP7ES	2412	0,8	BP7EVX	7270	206	BPR7EIX	4055
SR 500 (48T)	500	97 -	BPR7ES	2023	0,8	BPR7EVX	5565		BPR7EIX	4055
SR 500 E	500		BP7ES	2412	0,8	BP7EVX	7270	206	BPR7EIX	4055

				Order No.		Platin 	Order No.	Quick-No. 	Iridium	Order No.
YAMAHA										
SR 500 H	500		BP7ES	2412	0,8	BP7EVX	7270	206	BPR7EIX	4055
TT 500 (1T1)	500	78 - 79	BP7ES	2412	0,8	BP7EVX	7270	206	BPR7EIX	4055
TT 500 C	500		BP7ES	2412	0,8	BP7EVX	7270	206	BPR7EIX	4055
TT 500 E	500		BP7ES	2412	0,8	BP7EVX	7270	206	BPR7EIX	4055
TT 500 H	500		BP7ES	2412	0,8	BP7EVX	7270	206	BPR7EIX	4055
TZ 500	500				0,6	B10EVX	7335		BR10EIX	6801
TZ 500 H	500				0,6	B10EVX	7335		BR10EIX	6801
XJ 500	500		D8EA	2120	0,7	D8EVX	2850	216	DR8EIX	6681
XS 500 (1H2)	500	77 - 79	D8EA	2120	0,7	D8EVX	2850	216	DR8EIX	6681
XS 500 E	500		D8EA	2120	0,7	D8EVX	2850	216	DR8EIX	6681
XT 500 (1E6,1V6)	500	76 - 89	BP7ES	2412	0,8	BP7EVX	7270	206	BPR7EIX	4055
XT 500 C	500		BP7ES	2412	0,8	BP7EVX	7270	206	BPR7EIX	4055
XT 500 E	500	- 92	BP7ES	2412	0,8	BP7EVX	7270	206	BPR7EIX	4055
XT 500 E	500	93 -	DPR8EA-9	4929	0,9	DPR8EVX-9	2872	221	DPR8EIX-9	2202
XT 500 H	500		BP7ES	2412	0,8	BP7EVX	7270	206	BPR7EIX	4055
XT 500 T	500		DPR8EA-9	4929	0,9	DPR8EVX-9	2872	221	DPR8EIX-9	2202
XT 500 Z	500		DPR8EA-9	4929	0,9	DPR8EVX-9	2872	221	DPR8EIX-9	2202
XV 500 (I)	500		BPR7ES	2023	0,8	BPR7EVX	5565		BPR7EIX	4055
XV 500 SE (26R)	500	83 - 87	BPR7ES	2023	0,8	BPR7EVX	5565		BPR7EIX	4055
YP 500 Tmax ABS	500	05 -	CR7E	4578	0,6			225	CR7EIX	7385
XV 535 DX (H) VJ011 32kW	535	00 -	BPR6ES	7822	0,8	BPR6EVX	6764		BPR6EIX	6637
XV 535 DX (N) VJ012 25kW	535	00 -	BPR6ES	7822	0,8	BPR6EVX	6764		BPR6EIX	6637
XV 535 (2YL,3BR)	535	88 - 96	BPR7ES	2023	0,8	BPR7EVX	5565		BPR7EIX	4055
XV 535 (4KU / 4MC)	535	95 -	BPR7ES	2023	0,8	BPR7EVX	5565		BPR7EIX	4055
XV 535 S / SP (2YL,3BR)	535	93 - 96	BPR7ES	2023	0,8	BPR7EVX	5565		BPR7EIX	4055
XV 535/S(h) (2YL)	535	97 - 99	BPR6ES	7822	0,8	BPR6EVX	6764		BPR6EIX	6637
XV 535/S(n) (3BR)	535	97 - 99	BPR6ES	7822	0,8	BPR6EVX	6764		BPR6EIX	6637
YV 535 FC	535	94 -	BP7ES	2412	0,8	BP7EVX	7270	206	BPR7EIX	4055
XJ 550 (4V8)	550	81 - 83	D8EA	2120	0,6	D8EVX	2850	216	DR8EIX	6681
XJ 550 H	550		D8EA	2120	0,6	D8EVX	2850	216	DR8EIX	6681
XJ 550 RH	550		D8EA	2120	0,6	D8EVX	2850	216	DR8EIX	6681
XT 550 (5Y3)	550	82 - 83	DR7ES	3123	0,6					
XZ 550 (11V)	550	82 - 84	DR8ESL	2923	0,6	DR8EVX	6354	218	DR8EIX	6681
XZ 550 S (11V)	550	83 - 84	DR8ESL	2923	0,7	DR8EVX	6354	218	DR8EIX	6681
FZ 6 Fazer	600	04 -	CR9EK	4548	0,7			230	CR9EIX	3521
FZ 600,-U	600		DR8ESL	2923	0,7	DR8EVX	6354	218	DR8EIX	6681
FZR 600 (3HE,3RG,3RH)	600	89 - 93	CR9E	6263	0,7	CR9EVX	5943	227	CR9EIX	3521
FZR 600 F / R / RF / RFC	600	94 -	CR9E	6263	0,7	CR9EVX	5943	227	CR9EIX	3521
FZR 600 R (4JH) 72kW	600	94 -	CR9E	6263	0,7	CR9EVX	5943	227	CR9EIX	3521
FZR 600 R (4MH) 25kW	600	94 -	CR9E	6263	0,7	CR9EVX	5943	227	CR9EIX	3521
FZS 600 Fazer (RJ021)(5DM)	600	98 - 02	CR9E	6263	0,7	CR9EVX	5943	227	CR9EIX	3521
FZS 600 Fazer (RJ022)	600	98 - 02	CR8E	1275	0,7	CR8EVX	6487	226	CR8EIX	4218
FZS 600 Fazer	600	03 - 04	CR9EK	4548	0,7			230	CR9EIX	3521
SRX 600 (1XM,1XN)	600	86 - 89	DPR7EA-9	5129	0,9	DPR7EVX-9	7682	220	DPR7EIX-9	7803
TT 600	600	86 -	DPR7EA-9	5129	0,9	DPR7EVX-9	7682	220	DPR7EIX-9	7803
TT 600 RE (DJ012)	600	03 -	DPR8EA-9	4929	0,9	DPR8EVX-9	2872	221	DPR8EIX-9	2202
TT 600 (36A)	600	83 - 85	D7EA	7912	0,6	D7EVX	2734			
TT 600 E (4LW)	600	93 -	DPR8EA-9	4929	0,9	DPR8EVX-9	2872	221	DPR8EIX-9	2202
TT 600 R (DJ011)	600	98 -	DPR9EA-9	5329	0,9	DPR9EVX-9	3854	222	DPR9EIX-9	5545
TT 600 S (4LW)	600	93 -	DPR8EA-9	4929	0,9	DPR8EVX-9	2872	221	DPR8EIX-9	2202
TT 600 S (59X) (I)	600	85 - 89	DPR7EA-9	5129	0,9	DPR7EVX-9	7682	220	DPR7EIX-9	7803
XJ 600 (51J,3KM,3KN)	600	84 - 90	DR8ESL	2923	0,7	DR8EVX	6354	218	DR8EIX	6681

					Order No.		Platin 	Order No.	Quick-No.	Iridium 	Order No.
YAMAHA											
XJ 600 N (4KA)	600	95 -	CR8E	1275	0,6	CR8EVX	6487	226	CR8EIX	4218	
XJ 600 N (4MB)	600	95 -	CR8E	1275	0,6	CR8EVX	6487	226	CR8EIX	4218	
XJ 600 N (h) (4BR)	600	97 -	CR8E	1275	0,6	CR8EVX	6487	226	CR8EIX	4218	
XJ 600 N (n) (4LX)	600	97 -	CR7E	4578	0,6			225	CR7EIX	7385	
XJ 600 S (4EB / 4LX)	600	95 - 96	CR8E	1275	0,6	CR8EVX	6487	226	CR8EIX	4218	
XJ 600 S (4BR, 4BRA, 4BRB)	600	91 - 96	CR8E	1275	0,7	CR8EVX	6487	226	CR8EIX	4218	
XJ 600 S (h) (4BR)(1R..)	600	97 -	CR8E	1275	0,6	CR8EVX	6487	226	CR8EIX	4218	
XJ 600 S (n) (4LX)	600	97 -	CR7E	4578	0,7			225	CR7EIX	7385	
XJ 600 S / N (4LX)	600	94 - 96	CR9E	6263	0,7	CR9EVX	5943	227	CR9EIX	3521	
XT 600 (2KF,2NF)	600	87 - 90	DPR8EA-9	4929	0,9	DPR8EVX-9	2872	221	DPR8EIX-9	2202	
XT 600 (43F)	600	84 - 87	DR7ES	3123	0,6						
XT 600 E (4PT / 4SK)	600	95 -	DPR8EA-9	4929	0,9	DPR8EVX-9	2872	221	DPR8EIX-9	2202	
XT 600 E / EF / EFC	600	94 -	DPR8EA-9	4929	0,9	DPR8EVX-9	2872	221	DPR8EIX-9	2202	
XT 600 E(h) (3TB)	600	97 -	DPR8EA-9	4929	0,9	DPR8EVX-9	2872	221	DPR8EIX-9	2202	
XT 600 E(n) (3UW)	600	97 -	DPR8EA-9	4929	0,9	DPR8EVX-9	2872	221	DPR8EIX-9	2202	
XT 600 E/K (3TB/3UW)	600	90 - 94	DPR8EA-9	4929	0,9	DPR8EVX-9	2872	221	DPR8EIX-9	2202	
XT 600 S	600	86 - 86	DPR8EA-9	4929	0,9	DPR8EVX-9	2872	221	DPR8EIX-9	2202	
XT 600 Z (34L,55W)	600	83 - 85	DR7ES	3123	0,6						
XT 600 Z Tenere (1VJ,3AJ)	600	86 -	DPR7EA-9	5129	0,9	DPR7EVX-9	7682	220	DPR7EIX-9	7803	
YX 600	600		DR8ESL	2923	0,7	DR8EVX	6354	218	DR8EIX	6681	
YZF 600 R (4TV)	600	96 -	CR9E	6263	0,8	CR9EVX	5943	227	CR9EIX	3521	
YZF 600 R (4WD)	600	96 -	CR9E	6263	0,8	CR9EVX	5943	227	CR9EIX	3521	
YZF-R6	600	03 -	CR10EK	2360	0,6				CR10EIX	6482	
YZF-R6 (RJ031/032)	600	99 -	CR10EK	2360	0,6				CR10EIX	6482	
Drag Star (4VR/4XR)	650	97 -	DPR7EA-9	5129	0,9	DPR7EVX-9	7682	220	DPR7EIX-9	7803	
TS 650	650		B8ES	2411	0,6	B8EVX	7051	201	BR8EIX	5044	
XJ 650 (4K0)	650	80 - 83	BP7ES	2412	0,7	BP7EVX	7270	206	BPR7EIX	4055	
XJ 650 H	650		BP7ES	2412	0,7	BP7EVX	7270	206	BPR7EIX	4055	
XJ 650 LH	650		BP7ES	2412	0,7	BP7EVX	7270	206	BPR7EIX	4055	
XJ 650 SH	650		BP7ES	2412	0,7	BP7EVX	7270	206	BPR7EIX	4055	
XJ 650 T (Turbo) (11T)	650	82 -	BPR8ES	3923	0,7	BPR8EVX	5573	213			
XS 650 (447)	650	76 - 83	BP8ES	2912	0,7	BP8EVX	2671				
XS 650 (I)	650		BP7ES	2412	0,7	BP7EVX	7270	206	BPR7EIX	4055	
XS 650 E	650		BP7ES	2412	0,7	BP7EVX	7270	206	BPR7EIX	4055	
XS 650 H	650		BP7ES	2412	0,7	BP7EVX	7270	206	BPR7EIX	4055	
XS 650 II	650		BP7ES	2412	0,7	BP7EVX	7270	206	BPR7EIX	4055	
XS 650 S	650		BP7ES	2412	0,7	BP7EVX	7270	206	BPR7EIX	4055	
XS 650 SE (3L1)	650	79 - 81	BP7ES	2412	0,7	BP7EVX	7270	206	BPR7EIX	4055	
XS 650 SH	650		BP7ES	2412	0,7	BP7EVX	7270	206	BPR7EIX	4055	
XVS 650 Drag Star Classic (VM022)	650	98 -	DPR7EA-9	5129	0,9	DPR7EVX-9	7682	220	DPR7EIX-9	7803	
XVS 650 (4VR)	650	97 -	DPR7EA-9	5129	0,9	DPR7EVX-9	7682	220	DPR7EIX-9	7803	
XVS 650 Drag Star Classic (VM025)	650	98 -	DPR7EA-9	5129	0,9	DPR7EVX-9	7682	220	DPR7EIX-9	7803	
XVS 650 (4XR)	650	97 -	DPR7EA-9	5129	0,9	DPR7EVX-9	7682	220	DPR7EIX-9	7803	
SZR 660 (4SU)	660	96 - 96	DPR9EA-9	5329	0,9	DPR9EVX-9	3854	222	DPR9EIX-9	5545	
SZR 660 (4SU)	660	97 -	DPR8EA-9	4929	0,9	DPR8EVX-9	2872	221	DPR8EIX-9	2202	
XT 660 X	660	04 -	CR7E	4578	0,6			225	CR7EIX	7385	
XT 660 R	660	04 -	CR7E	4578	0,6			225	CR7EIX	7385	
XTZ 660 (4MD)	660	94 -	DR8EA	7162	0,9	DR8EVX	6354		DR8EIX	6681	
XTZ 660 (3YF)	660	97 -	DPR8EA-9	4929	0,9	DPR8EVX-9	2872	221	DPR8EIX-9	2202	
XTZ 660 (3YF)	660	91 - 93	DPR9EA-9	5329	0,9	DPR9EVX-9	3854	222	DPR9EIX-9	5545	
YFM 660 FWA Grizzly (ATV)	660	02 - 04	DPR8EA-9	4929	0,9	DPR8EVX-9	2872	221	DPR8EIX-9	2202	
YFM 660 R Raptor (ATV)	660	01 - 04	DPR8EA-9	4929	0,9	DPR8EVX-9	2872	221	DPR8EIX-9	2202	

				Order No.		Platin 	Order No.	Quick-No. 	Iridium 	Order No.
YAMAHA										
YXR 660 Rhino (ATV)	660	05 -	DPR8EA-9	4929	0,9	DPR8EVX-9	2872	221	DPR8EIX-9	2202
YXR 660 FAS (ATV)	660	04 -	DPR8EA-9	4929	0,9	DPR8EVX-9	2872	221	DPR8EIX-9	2202
750 Laguna Seca (11M)	750	82 -	BP7ES	2412	0,7	BP7EVX	7270	206	BPR7EIX	4055
FZ 750 (1FN)	750	85 - 86	DR8ESL	2923	0,7	DR8EVX	6354	218	DR8EIX	6681
FZ 750 (3KT)	750	91 -	DR8ESL	2923	0,6	DR8EVX	6354	218	DR8EIX	6681
FZ 750 Genesis (2KK)	750	87 - 90	DR8ESL	2923	0,6	DR8EVX	6354	218	DR8EIX	6681
FZR 750 R (3PJ,3CV)	750	88 - 92	DR8EA	7162	0,7	DR8EVX	6354		DR8EIX	6681
FZX 750 (2JE)	750	87 - 89	DR8ESL	2923	0,6	DR8EVX	6354	218	DR8EIX	6681
FZX 750 Phaser (I)	750		DR8ESL	2923	0,7	DR8EVX	6354	218	DR8EIX	6681
TZ 750	750		B10EG	3630	0,5	B10EGV	5927			
TZ 750 D	750				0,6	B10EVX	7335		BR10EIX	6801
XJ 750	750	- 83	B7ES	1111	0,7	B7EVX	6934			
XJ 750 (41Y)	750	84 - 85	BPR8ES	3923	0,7	BPR8EVX	5573	213		
XJ 750 RH	750		B7ES	1111	0,7	B7EVX	6934			
XS 750 (1T5)	750	77 - 79	B7ES	1111	0,7	B7EVX	6934			
XS 750 C	750		B7ES	1111	0,7	B7EVX	6934			
XS 750 D	750		B7ES	1111	0,7	B7EVX	6934			
XS 750 E	750		B7ES	1111	0,7	B7EVX	6934			
XS 750 S	750		B7ES	1111	0,7	B7EVX	6934			
XS 750 SE	750		B7ES	1111	0,7	B7EVX	6934			
XS 750 T	750		B7ES	1111	0,7	B7EVX	6934			
XTS 750 SE	750		B7ES	1111	0,7	B7EVX	6934			
XTZ 750 (3LD, 3WM)	750	89 -	DPR8EA-9	4929	0,9	DPR8EVX-9	2872	221	DPR8EIX-9	2202
XV 750	750	- 83	B7ES	1111	0,7	B7EVX	6934			
XV 750 (4PW)	750	95 -	BPR7ES	2023	0,8	BPR7EVX	5565		BPR7EIX	4055
XV 750 / F / FC	750	84 -	BPR7ES	2023	0,7	BPR7EVX	5565		BPR7EIX	4055
XV 750 SE (5G5)	750	81 - 82	B7ES	1111	0,7	B7EVX	6934			
XV 750 SE (I)	750		BP7ES	2412	0,7	BP7EVX	7270	206	BPR7EIX	4055
YZF 750 R / RF / RFC (4HN)	750	93 -	CR9E	6263	0,9	CR9EVX	5943	227	CR9EIX	3521
YZF 750 SP / SPF (4HT)	750	93 -	CR9E	6263	0,8	CR9EVX	5943	227	CR9EIX	3521
YZF-R7 (RM011)	750	01 -	R-0256R-10	7641	1,0					
TDM 850 (4TX)	850	96 - 96	DPR9EA-9	5329	0,9	DPR9EVX-9	3854	222	DPR9EIX-9	5545
TDM 850 (3VD)	850	97 -	DPR8EA-9	4929	0,9	DPR8EVX-9	2872	221	DPR8EIX-9	2202
TDM 850 (4TX)	850	97 -	DPR8EA-9	4929	0,9	DPR8EVX-9	2872	221	DPR8EIX-9	2202
TDM 850 / F (3VD)	850	91 - 95	DPR8EA-9	4929	0,9	DPR8EVX-9	2872	221	DPR8EIX-9	2202
TRX 850	850	95 - 95	DPR8EA-9	4929	0,9	DPR8EVX-9	2872	221	DPR8EIX-9	2202
TRX 850 (4UN)	850	96 - 96	DPR9EA-9	5329	0,9	DPR9EVX-9	3854	222	DPR9EIX-9	5545
TRX 850 (4UN)	850	97 -	DPR8EA-9	4929	0,9	DPR8EVX-9	2872	221	DPR8EIX-9	2202
XS 850 (4E2)	850	80 - 81	BP7ES	2412	0,7	BP7EVX	7270	206	BPR7EIX	4055
XS 850 H	850		BP7ES	2412	0,7	BP7EVX	7270	206	BPR7EIX	4055
XS 850 LH	850		BP7ES	2412	0,7	BP7EVX	7270	206	BPR7EIX	4055
XS 850 SH	850		BP7ES	2412	0,7	BP7EVX	7270	206	BPR7EIX	4055
TDM 900	900	02 -	DPR8EA-9	4929	0,9	DPR8EVX-9	2872	221	DPR8EIX-9	2202
XJ 900 (31A)	900	83 - 84	BPR8ES	3923	0,7	BPR8EVX	5573	213		
XJ 900 (4BB)	900	91 -	BPR8ES	3923	0,7	BPR8EVX	5573	213		
XJ 900 (58L)	900	85 - 90	BPR8ES	3923	0,7	BPR8EVX	5573	213		
XJ 900 S (4KM)	900	95 -	DPR8EA-9	4929	0,9	DPR8EVX-9	2872	221	DPR8EIX-9	2202
XV 920 RH	920		BP7ES	2412	0,7	BP7EVX	7270	206	BPR7EIX	4055
FZR 1000 / FC (3LE)	1000	94 -	DR8EA	7162	0,7	DR8EVX	6354		DR8EIX	6681
FZR 1000 EXUP (I)	1000		DR8ESL	2923	0,7	DR8EVX	6354	218	DR8EIX	6681
FZR 1000 F	1000	94 -	DP8EA-9	5829	0,9	DPR8EVX-9	2872		DPR8EIX-9	2202
FZR 1000 / U	1000		DR8ESL	2923	0,7	DR8EVX	6354	218	DR8EIX	6681

					Order No.		Platin 	Order No.	Quick-No.	Iridium 	Order No.
YAMAHA											
FZS 1000 Fazer(RN064)	1000	01 -	CR9E	6263	0,7	CR9EVX	5943	227	CR9EIX		3521
GTS 1000 (4BH)	1000	92 -	DPR8EA-9	4929	0,9	DPR8EVX-9	2872	221	DPR8EIX-9		2202
GTS 1000 A / AF / AFC (4BH)	1000	92 -	DPR8EA-9	4929	0,9	DPR8EVX-9	2872	221	DPR8EIX-9		2202
TR1 (578)	1000	81 - 82	BPR7ES	2023	0,7	BPR7EVX	5565		BPR7EIX		4055
XV 1000 / F / FC	1000		BPR7ES	2023	0,7	BPR7EVX	5565		BPR7EIX		4055
XV 1000 SE (23W,2AE)	1000	83 - 88	BPR7ES	2023	0,7	BPR7EVX	5565		BPR7EIX		4055
XV 1000 SH	1000		BPR7ES	2023	0,7	BPR7EVX	5565		BPR7EIX		4055
YZF 1000 R (4VD)	1000	97 -	DPR8EA-9	4929	0,9	DPR8EVX-9	2872	221	DPR8EIX-9		2202
YZF R1 (RN012)(RN04)	1000	98 - 01	CR9E	6263	0,7	CR9EVX	5943	227	CR9EIX		3521
YZF R1	1000	02 - 03				CR9EIA-9	6289				
YZF 1000 (4VD)	1000	96 -	DR8EA	7162	0,7	DR8EVX	6354		DR8EIX		6681
YZF-R1	1000	04 -	CR9EK	4548	0,7		230		CR9EIX		3521
BT 1100 Bulldog	1100	02 -	BPR7ES	2023	0,6	BPR7EVX	5565		BPR7EIX		4055
FJ 1100 (47E)	1100	84 - 85	DPR8EA-9	4929	0,9	DPR8EVX-9	2872	221	DPR8EIX-9		2202
XS 1100 (2H9)	1100	78 - 82	BP6ES	7811	0,7	BP6EVX	5832		BPR6EIX		6637
XS 1100 E	1100		BP6ES	7811	0,7	BP6EVX	5832		BPR6EIX		6637
XS 1100 H	1100		BP6ES	7811	0,7	BP6EVX	5832		BPR6EIX		6637
XS 1100 LH	1100		BP6ES	7811	0,7	BP6EVX	5832		BPR6EIX		6637
XS 1100 RH	1100		BP6ES	7811	0,7	BP6EVX	5832		BPR6EIX		6637
XS 1100 S (5K7)	1100	81 - 82	BP6ES	7811	0,7	BP6EVX	5832		BPR6EIX		6637
XS 1100 SH	1100		BP6ES	7811	0,7	BP6EVX	5832		BPR6EIX		6637
XV 1100 (3LP)	1100	95 -	BPR7ES	2023	0,8	BPR7EVX	5565		BPR7EIX		4055
XV 1100 SC	1100		BPR7ES	2023	0,8	BPR7EVX	5565		BPR7EIX		4055
XVS 1100 Drag Star (VP05)	1100	99 -	BPR7ES	2023	0,7	BPR7EVX	5565		BPR7EIX		4055
FJ 1200 (1XJ)	1200	86 - 87	DPR8EA-9	4929	0,9	DPR8EVX-9	2872	221	DPR8EIX-9		2202
FJ 1200 (3CW)	1200	88 - 90	DPR8EA-9	4929	0,9	DPR8EVX-9	2872	221	DPR8EIX-9		2202
FJ 1200 (3YA)	1200	91 -	DPR8EA-9	4929	0,9	DPR8EVX-9	2872	221	DPR8EIX-9		2202
FJ 1200 AE/ AEC / E / F	1200	93 -	DP8EA-9	5829	0,9	DPR8EVX-9	2872		DPR8EIX-9		2202
VMAX 1200 (2EN)	1200	97 -	DPR8EA-9	4929	0,9	DPR8EVX-9	2872	221	DPR8EIX-9		2202
VMAX 1200 (2EN) (I)	1200		DPR8EA-9	4929	0,9	DPR8EVX-9	2872	221	DPR8EIX-9		2202
VMX 1200 / F / FC	1200		DPR8EA-9	4929	0,9	DPR8EVX-9	2872	221	DPR8EIX-9		2202
XJR 1200 (4PU)	1200	95 -	DPR8EA-9	4929	0,9	DPR8EVX-9	2872	221	DPR8EIX-9		2202
XJR 1200 (4PU)	1200	97 -	DPR8EA-9	4929	0,9	DPR8EVX-9	2872	221	DPR8EIX-9		2202
XVZ 1200 TD	1200		DPR8EA-9	4929	0,9	DPR8EVX-9	2872	221	DPR8EIX-9		2202
XVZ 12T (47G)	1200	84 - 87	DPR8EA-9	4929	0,9	DPR8EVX-9	2872	221	DPR8EIX-9		2202
FJR 1300	1300	01 -	CR8E	1275	0,7	CR8EVX	6487	226	CR8EIX		4218
FJR 1300 A	1300	03 -	CR8E	1275	0,7	CR8EVX	6487	226	CR8EIX		4218
Royal Star(4YP)	1300	97 -	DPRT7EA-9	5129	0,9	DPRT7EVX-9	7682	220	DPRT7EIX-9		7803
XJR 1300	1300	98 -	DPR8EA-9	4929	0,9	DPR8EVX-9	2872	221	DPR8EIX-9		2202
XJR 1300 (RP022)	1300	99 -	DPR8EA-9	4929	0,9	DPR8EVX-9	2872	221	DPR8EIX-9		2202
XJR 1300 SP (RP022)	1300	99 -	DPR8EA-9	4929	0,9	DPR8EVX-9	2872	221	DPR8EIX-9		2202
XVZ 13 A (4NK)	1300	97 -	DPRT7EA-9	5129	0,9	DPRT7EVX-9	7682	220	DPRT7EIX-9		7803
XVZ 13 A (4YP)	1300	97 -	DPRT7EA-9	5129	0,9	DPRT7EVX-9	7682	220	DPRT7EIX-9		7803
XVZ 13DE	1300	93 -	DPR8EA-9	4929	0,9	DPR8EVX-9	2872	221	DPR8EIX-9		2202
XV 1600 Wild Star (VP981)	1600	03.99 -	DPRT7EA-9	5129	0,9	DPRT7EVX-9	7682	220	DPRT7EIX-9		7803
MT-01	1670	05 -	DPRT7EA-9	5129	0,9	DPRT7EVX-9	7682	220	DPRT7EIX-9		7803
XU 1700 Road Star Warrior	1670	03 -	DPRT7EA-9	5129	0,9	DPRT7EVX-9	7682	220	DPRT7EIX-9		7803
YERF-DOG											
23000 (ATV)	90	04 -	BP7HS	5111	0,7	BP7HVX	7468		BPR7HIX		5944
23100 (ATV)	150	04 -	BR6ES	4922	0,6						



Order No.



Gold-Palladium

Platin



Order No.

Quick-No.

Iridium









Order No.







ZID







Woshod	128.000-01-900	10,3kW	175		BP7HS	5111	0,7	BP7HVX	7468		BPR7HIX	5944
Woshod	144.000-01-900	9,9kW	175		BP7HS	5111	0,7	BP7HVX	7468		BPR7HIX	5944
Woshod	124.000-01-900	7,7kW	175		BP7HS	5111	0,7	BP7HVX	7468		BPR7HIX	5944
Fermer	3DK5.904	9,6kW	197		BP7HS	5111	0,7	BP7HVX	7468		BPR7HIX	5944
Zid-200	3Dk5.104	11,1kW	197		BP7HS	5111	0,7	BP7HVX	7468		BPR7HIX	5944
Sova		11kW	200		BP7HS	5111	0,7	BP7HVX	7468		BPR7HIX	5944







ZÜNDAPP







KS 50 12.7 mm Gewindelänge		50			B7HS	5110	0,5	B7HVX	7836	204	BR7HIX	7067
KS 50 19.0 mm Gewindelänge		50			B7ES	1111	0,5	B7EVX	6934			
KS 50 Cross/Sport 517		50			B8HS	5510	0,5	B8HVX	2634	205	BR8HIX	7001
KS 50 Sport/Super Sport		50			B8HS	5510	0,5	B8HVX	2634	205	BR8HIX	7001
KS 50 TT/WK		50			B9ES	2611	0,5	B9EVX	7254	202	BR9EIX	3981
K 80		80			B8ES	2411	0,5	B8EVX	7051	201	BR8EIX	5044
KS 80		80			B8ES	2411	0,5	B8EVX	7051	201	BR8EIX	5044
KS 80 Super		80			B8ES	2411	0,5	B8EVX	7051	201	BR8EIX	5044
KS 80 Touring		80			B8ES	2411	0,5	B8EVX	7051	201	BR8EIX	5044
KS 125		125			B8HS	5510	0,5	B8HVX	2634	205	BR8HIX	7001
KS 125 GS		125			B8HS	5510	0,5	B8HVX	2634	205	BR8HIX	7001
KS 125 MC		125			B8HS	5510	0,5	B8HVX	2634	205	BR8HIX	7001
KS 600		600	38 -		BP6HS	4511	0,6	BP6HVX	4635		BPR6HIX	4085
KS 601		600			BP7HS	5111	0,5	BP7HVX	7468		BPR7HIX	5944







					Order No.		Platin 	Order No.	Quick-No.	Iridium 	Order No.
APRILIA											
Amico 25 (MK)	25	96 -	BR7HS	4122	0,5	---		211	BR7HIX	7067	
Amico GL (HV)	50		BR7HS	4122	0,5	---		211	BR7HIX	7067	
Amico LX / LK / Sport	50		BR7HS	4122	0,5	---		211	BR7HIX	7067	
Amico 50	50	01.90 - 95	BR7HS	4122	0,6	---		211	BR7HIX	7067	
Amico 50 Clubmann	50	97 -	BR7HS	4122	0,5	---		211	BR7HIX	7067	
Area 51 (MY)	50	99 -	BR8HS	4322	0,7	BR8HVX	6265	212	BR8HIX	7001	
Gulliver AC (LH)	50		BR7HS	4122	0,5	---		211	BR7HIX	7067	
Gulliver 50 LC (LH)	50	96 -	BR8HS	4322	0,7	BR8HVX	6265	212	BR8HIX	7001	
Gulliver 50	50	01.95 - 96	BR7HS	4122	0,6	---		211	BR7HIX	7067	
Gulliver 50 H2O	50	01.96 -	BR8HS	4322	0,6	BR8HVX	6265	212	BR8HIX	7001	
Habana 50 / Custom (PK)	50	99 -	BPR8HS	3725	0,6	---			BPR8HIX	6742	
Mojito Custom 50	50	99 -	BPR8HS	3725	0,6	---			BPR8HIX	6742	
MX 50 (RX50)	50	03 -	BR9ES	5722	0,6	BR9EVX	1265	208	BR9EIX	3981	
Rally 50 AC (MD)	50		BR7HS	4122	0,5	---		211	BR7HIX	7067	
Rally 50	50	01.95 - 96	BR8HS	4322	0,6	BR8HVX	6265	212	BR8HIX	7001	
Rally 50 LC / Fun (MZ)	50	96 -	BR8HS	4322	0,5	BR8HVX	6265	212	BR8HIX	7001	
Rally 50 H2O	50	01.96 -	BR8HS	4322	0,6	BR8HVX	6265	212	BR8HIX	7001	
Scarabeo 50	50	93 - 03	BR7HS	4122	0,5	---		211	BR7HIX	7067	
Scarabeo De Luxe	50	98 - 03	BR7HS	4122	0,5	---		211	BR7HIX	7067	
Scarabeo 50 (DiTech)	50	07.00 -	CPR8E	7411	0,6	---			---		
Sonic 50 (PB)	50		BR8HS	4322	0,6	BR8HVX	6265	212	BR8HIX	7001	
Sonic 50 G.P. / Spice	50	01.98 -	BR8HS	4322	0,6	BR8HVX	6265	212	BR8HIX	7001	
SR 50 AC (LY)	50	93 -	BR7HS	4122	0,5	---		211	BR7HIX	7067	
SR 50 i.e. (RLE) (DiTech)25km/h	50	01 -	CPR8E	7411	0,6	---			---		
SR 50	50	01.92 - 96	BR7HS	4122	0,6	---		211	BR7HIX	7067	
SR 50 i.e. (RLB) (DiTech)	50	07.00 -	CPR8E	7411	0,6	---			---		
SR 50 LC (MZA)	50	93 -	BR8HS	4322	0,5	BR8HVX	6265	212	BR8HIX	7001	
SR 50 WWW - Netscaper	50	01.97 -	BR8HS	4322	0,6	BR8HVX	6265	212	BR8HIX	7001	
SR 50 H2O (RLA)	50	00 -	BPR8HS	3725	0,6	---			BPR8HIX	6742	
SR 50 H2O (I)	50	01.96 -	BR8HS	4322	0,6	BR8HVX	6265	212	BR8HIX	7001	
Scarabeo 100 (RE) 2T	100	00 -	BR8HS	4322	0,7	BR8HVX	6265	212	BR8HIX	7001	
Scarabeo 100 (SA) 4T	100	00 -	CR7E	4578	0,7	---		225	CR7EIX	7385	
Atlantic 125	125	03 -	CR8EB	7784	0,6	---			CR8EIX	4218	
Habana 125 (PM)	125	99 -	CR7E	4578	0,7	---		225	CR7EIX	7385	
Leonardo 125 (MB)	125	01.95 -	CR8E	1275	0,7	CR8EVX	6487	226	CR8EIX	4218	
Mojito 125 Custom	125	05 -	CR9E	6263	0,7	CR9EVX	5943	227	CR9EIX	3521	
Scarabeo 125 (PC)	125	99 -	CR8E	1275	0,6	CR8EVX	6487	226	CR8EIX	4218	
Sportcity 125	125		CR8EB	7784	0,6	---			CR8EIX	4218	
SR 125 AC	125	99 -	BR8ES	5422	0,6	BR8EVX	1262	207	BR8EIX	5044	
Leonardo 150	150	02 -	DR8EA	7162	0,6	DR8EVX	6354		DR8EIX	6681	
Leonardo 150 (MBA)	150	01.97 - 00	CR8E	1275	0,7	CR8EVX	6487	226	CR8EIX	4218	
Leonardo 150 (MBA)	150	01.97 - 00	CR8E	1275	0,7	CR8EVX	6487	226	CR8EIX	4218	
Scarabeo 150 (PCA)	150	99 -	CR8E	1275	0,6	CR8EVX	6487	226	CR8EIX	4218	
SR 150	150		BR9ES	5722	0,6	BR9EVX	1265	208	BR9EIX	3981	
Atlantic 200	200	03 -	CR8EB	7784	0,6	---			CR8EIX	4218	
Scarabeo	200	00 -	---		0,6	CR8EVX	6487	226	CR8EIX	4218	
Atlantic 250	250	04 -	CR8EB	7784	0,6	---			CR8EIX	4218	
Leonardo 250 (PD)	250	98 - 00	DR8EA	7162	0,6	DR8EVX	6354		DR8EIX	6681	
Leonardo 300	300	03 -	DR8EA	7162	0,6	DR8EVX	6354		DR8EIX	6681	
Atlantic 500	500	02 -	CR7EKB	4455	0,6	---			---		
Scarabeo 500	500	02 -	CR7EKB	4455	0,6	---			---		







				Order No.		Platin 	Order No.	Quick-No. 	Iridium	Order No.	
ATALA											
Byte	50		B7HS	5110	0,6	B7HVX	7836	204	BR7HIX	7067	
Byte 25	50	96 -	BPR6HS	7022	0,6	BPR6HVX	2740	214	BPR6HIX	4085	
Byte 50	50	96 -	BPR6HS	7022	0,6	BPR6HVX	2740	214	BPR6HIX	4085	
Carosello	50		B7HS	5110	0,6	B7HVX	7836	204	BR7HIX	7067	
Hacker - Hacker Racing	50		BPR6HS	7022	0,6	BPR6HVX	2740	214	BPR6HIX	4085	
Hacker AT12	50	96 -	BPR6HS	7022	0,5	BPR6HVX	2740	214	BPR6HIX	4085	
Hacker AT12 Racing	50	96 -	BPR6HS	7022	0,5	BPR6HVX	2740	214	BPR6HIX	4085	
Hacker AT12 Racing LC	50	96 -	BPR6HS	7022	0,5	BPR6HVX	2740	214	BPR6HIX	4085	
Master LF	50	96 -	B6HS	4510	0,5	B6HVX	7435	203	BR6HIX	3419	
Racing	50	96 -	BPR6HS	7022	0,5	BPR6HVX	2740	214	BPR6HIX	4085	
Skeggia	50	01.98 -	BPR6HS	7022	0,6	BPR6HVX	2740	214	BPR6HIX	4085	
BAJAJ											
Spirit	50	99 -	B6HS	4510	0,5	B6HVX	7435	203	BR6HIX	3419	
Sunny 50	50	97 -	B6HS	4510	0,5	B6HVX	7435	203	BR6HIX	3419	
Chetak	125		BP5HS	4111	0,6	---			---		
Chetak 125 Electr.	125		BP6HS	4511	0,6	BP6HVX	4635		BPR6HIX	4085	
Chetak 125 electr.; D	125		BP6HS	4511	0,6	BP6HVX	4635		BPR6HIX	4085	
Chetak 125 Electr.D	125		BP6HS	4511	0,6	BP6HVX	4635		BPR6HIX	4085	
Chetak	150		BP5HS	4111	0,6	---			---		
Chetak 150 Classic	150		BPR5HS	6222	0,6	---			---		
Chetak 150 Classic Green	150		BPR5HS	6222	0,6	---			---		
Chetak 150 Classic Sidec	150		BPR5HS	6222	0,6	---			---		
Chetak 150 Electr.	150		BPR5HS	6222	0,6	---			---		
Chetak 150 electr.; D; Classic; Sidec; Green	150		BPR5HS	6222	0,6	---			---		
Chetak 150 Electr.D	150		BPR5HS	6222	0,6	---			---		
BENELLI											
491 only Italien	50		BR8ES	5422	0,6	BR8EVX	1262	207	BR8EIX	5044	
491 Sport watercooler	50	97 -	BR7HS	4122	0,6	---		211	BR7HIX	7067	
491 GT aircooler	50	97 -	BR7HS	4122	0,6	---			211	BR7HIX	7067
491 Racing watercooler	50	97 -	BR7HS	4122	0,6	---			211	BR7HIX	7067
491 Superbike watercooler	50	99 -	BR7HS	4122	0,6	---			211	BR7HIX	7067
491 Rage ST	50	00 -	BR8HS	4322	0,7	BR8HVX	6265	212	BR8HIX	7001	
491 ST GP	50	00 -	BR8HS	4322	0,7	BR8HVX	6265	212	BR8HIX	7001	
491 SBK	50	00 -	BR8HS	4322	0,7	BR8HVX	6265	212	BR8HIX	7001	
K2 air cool	50		BR7HS	4122	0,6	---		211	BR7HIX	7067	
K2 liquid cool/watercooler	50		BR8HS	4322	0,6	BR8HVX	6265	212	BR8HIX	7001	
K2 Namur	50	00 -	BR8HS	4322	0,7	BR8HVX	6265	212	BR8HIX	7001	
Laser 50	50		B6HS	4510	0,5	B6HVX	7435	203	BR6HIX	3419	
Naked 50	50		BR8HS	4322	0,6	BR8HVX	6265	211	BR8HIX	7001	
Pepe	50	99 -	BR7HS	4122	0,6	---		211	BR7HIX	7067	
Pepe Kat	50	99 -	BR8HS	4322	0,6	BR8HVX	6265	212	BR8HIX	7001	
S 50	50		B6HS	4510	0,5	B6HVX	7435	203	BR6HIX	3419	
Scoothy 50	50		B6HS	4510	0,6	B6HVX	7435	203	BR6HIX	3419	
K2 100	100	99 -	BR8HS	4322	0,7	BR8HVX	6265	212	BR8HIX	7001	
Adiva 125	125		CR8EB	7784	0,6	---			CR8EIX	4218	
Velvet Eco 125	125	99 -	CR8E	1275	0,6	CR8EVX	6487	226	CR8EIX	4218	
Adiva 150	150		CR8EB	7784	0,6	---			CR8EIX	4218	
Velvet Eco 150	150	99 -	CR8E	1275	0,6	CR8EVX	6487	226	CR8EIX	4218	
Velvet Eco 250	250	00 -	DR8EA	7162	0,7	DR8EVX	6354		DR8EIX	6681	
Dusk 400	400	05 -	CR9E	6263	0,7	CR9EVX	5943		CR9EIX	3521	







					Order No.		Platin 	Order No.	Quick-No.	Iridium 	Order No.
BETA											
Ark aircooler	50	97 -	BR7HS	4122	0,6	---			211	BR7HIX	7067
Ark watercooler	50	97 -	BR8HS	4322	0,6	BR8HVX	6265	212	BR8HIX	7001	
Chrono 50	50	95 -	BR7HS	4122	0,5	---		211	BR7HIX	7067	
Chrono 502	50	95 -	BR7HS	4122	0,5	---		211	BR7HIX	7067	
Eikon	50	98 -	BR8HS	4322	0,6	BR8HVX	6265	212	BR8HIX	7001	
Quadra 50	50	95 -	BR7HS	4122	0,6	---		211	BR7HIX	7067	
Tempo 50	50	94 -	BR7HS	4122	0,5	---		211	BR7HIX	7067	
Tempo 50 13"	50	96 -	BR7HS	4122	0,5	---		211	BR7HIX	7067	
Tempo 50 16"	50	96 -	BR7HS	4122	0,5	---		211	BR7HIX	7067	
Alp 125	125		DR8EA	7162	0,6	DR8EVX	6354		DR8EIX	6681	
Alp 4T 200	125		DR8EA	7162	0,6	DR8EVX	6354		DR8EIX	6681	
Eikon 125	125	99 -	DR8EA	7162	0,6	DR8EVX	6354		DR8EIX	6681	
Eikon 150	250	99 -	DPR7EA-9	5129	0,9	DPR7EVX-9	7682	220	DPR7EIX-9	7803	
REV-3	250		BP7ES	2412	0,6	BP7EVX	7270		BPR7EIX	4055	
BMW											
C1 125 4T	125	04.00 - 03	CR8EB	7784	0,6	---			CR8EIX	4218	
C1 200 4T	180	00 - 03	CR8EB	7784	0,6	---			CR8EIX	4218	
BS VILLA											
Giorno	50		BR8HSA	5539	0,6	BR8HVX	6265		BR8HIX	7001	
GP Dio	50	90 -	BPR8HS	3725	0,6	---			BPR8HIX	6742	
SP Dio	50		BPR7HS	6422	0,6	BPR7HVX	2938	215	BPR7HIX	5944	
Z5	50	93 -	BR8HSA	5539	0,6	BR8HVX	6265		BR8HIX	7001	
ZX	50	93 -	BR8HSA	5539	0,6	BR8HVX	6265		BR8HIX	7001	
BUFFALO											
CY 25	50	97 -	BR7HS	4122	0,6	---		211	BR7HIX	7067	
CY 50	50	97 -	BR7HS	4122	0,6	---		211	BR7HIX	7067	
CY 50 aircooled	50	96 -	BR7HS	4122	0,6	---		211	BR7HIX	7067	
MK 50	50	96 -	BP7HS	5111	0,6	BP7HVX	7468		BPR7HIX	5944	
MM 50	50	97 -	BR7HS	4122	0,6	---		211	BR7HIX	7067	
MY 50 aircooled	50	96 -	BR7HS	4122	0,6	---		211	BR7HIX	7067	
Silver watercooled	50	96 -	BR8ES	5422	0,5	BR8EVX	1262	207	BR8EIX	5044	
CAGIVA											
City	50	93 -	B7HS	5110	0,5	B7HVX	7836	204	BR7HIX	7067	
City	50	94 - 97	BPR8HS	3725	0,6	---			BPR8HIX	6742	
City	50	98 -	BR8HSA	5539	0,5	BR8HVX	6265		BR8HIX	7001	
City L.E.	50	93 -	B7HS	5110	0,5	B7HVX	7836	204	BR7HIX	7067	
City, City LE	50	01.93 -	B7HS	5110	0,6	B7HVX	7836	204	BR7HIX	7067	
Cucciolo	50		B8HS	5510	0,6	B8HVX	2634	205	BR8HIX	7001	
Mantis	50	99 -	B9ES	2611	0,6	B9EVX	7254	202	BR9EIX	3981	
Passing	50		BP6HS	4511	0,6	BP6HVX	4635		BPR6HIX	4085	
Progress 50	50		B8HS	5510	0,6	B8HVX	2634	205	BR8HIX	7001	
Progress Corsa	50		B9ES	2611	0,6	B9EVX	7254	202	BR9EIX	3981	
Scooter	50	93 -	BR8HSA	5539	0,7	BR8HVX	6265		BR8HIX	7001	
Cucciolo	125	99 -	CR7E	4578	0,7	---		225	CR7EIX	7385	
Nuvola	125		CR7E	4578	0,7	---		225	CR7EIX	7385	
Passing	125	95 -	BP6HS	4511	0,6	BP6HVX	4635		BPR6HIX	4085	







					Order No.		Platin 	Order No.	Quick-No.	Iridium 	Order No.
CAPRI											
Roller 50	50		B7ES	1111	0,5	B7EVX	6934		---		
Roller 50S	50		B8ES	2411	0,5	B8EVX	7051	201	BR8EIX		5044
Roller 125	125		B8HS	5510	0,6	B8HVX	2634	205	BR8HIX		7001
CCF											
Adly 50	50	96 -	BP7HS	5111	0,6	BP7HVX	7468			BPR7HIX	5944
Cat 50	50	97 -	BP7HS	5111	0,6	BP7HVX	7468			BPR7HIX	5944
Adly 100	100	96 -	BP7HS	5111	0,6	BP7HVX	7468			BPR7HIX	5944
Cat 125	125	98 -	CR7HSA	4549	0,6	---				CR7HIX	7544
CPI											
GTR 50	50	03 -	BR7ES	5122	0,8	BR7EVX	4556				
GTS 50	50	03 -	BR7ES	5122	0,8	BR7EVX	4556				
Hussar 50	50	03 -	BR7ES	5122	0,8	BR7EVX	4556				
Oliver 50	50	03 -	BR7ES	5122	0,8	BR7EVX	4556				
Popcorn 50	50	03 -	BR7ES	5122	0,8	BR7EVX	4556				
GTS 125	125	03 -	BR7ES	5122	0,8	BR7EVX	4556				
X-Large 125	125	03 -	BR7ES	5122	0,8	BR7EVX	4556				
GTS 150	150	03 -	BR7ES	5122	0,8	BR7EVX	4556				
X-Large 150	150	03 -	BR7ES	5122	0,8	BR7EVX	4556				
GTS 200	200	03 -	BR7ES	5122	0,8	BR7EVX	4556				
X-Large 200	200	03 -	BR7ES	5122	0,8	BR7EVX	4556				
DAELIM											
Cordi 50	50	04 -	BPR6HS	7022	0,6	BPR6HVX	2740	214	BPR6HIX		4085
E-Five	50	03 -	B8HS	5510	0,6	B8HVX	2634	205	BR8HIX		7001
Message	50	98 -	BR8HSA	5539	0,6	BR8HVX	6265			BR8HIX	7001
S-Five	50	02 -	B8HS	5510	0,6	B8HVX	2634	205	BR8HIX		7001
Tapo	50	98 -	BR8HSA	5539	0,6	BR8HVX	6265			BR8HIX	7001
Delfino	100		BR8HS	4322	0,6	BR8HVX	6265	212	BR8HIX		7001
Citi Ace 110	110	03 -	C7HSA	4629	0,7	C7HVX	4533			CR7HIX	7544
History 125	125		CR8EH-9	5666	0,9	CR8EHVX-9	4546	228	CR8EHIX-9		3797
NS 125	125	98 -	CR8EH-9	5666	0,9	CR8EHVX-9	4546	228	CR8EHIX-9		3797
Othello	125	98 -	CR8EH-9	5666	0,9	CR8EHVX-9	4546	228	CR8EHIX-9		3797
VC 125	125	97 -	CR8EH-9	5666	0,9	CR8EHVX-9	4546	228	CR8EHIX-9		3797
VS 125	125	97 -	CR8EH-9	5666	0,9	CR8EHVX-9	4546	228	CR8EHIX-9		3797
DERBI											
Atlantis LC	50		B9ES	2611	0,6	B9EVX	7254	202	BR9EIX		3981
Atlantis O2	50	99 -	B8HS	5510	0,6	B8HVX	2634	205	BR8HIX		7001
Atlantis Air	50	03 -	BR9ES	5722	0,6	BR9EVX	1265	208	BR9EIX		3981
Atlantis City	50	03 -	BR9ES	5722	0,6	BR9EVX	1265	208	BR9EIX		3981
Aventura	50	95 -	B8HS	5510	0,6	B8HVX	2634	205	BR8HIX		7001
Bullet	50	03 -	BR9ES	5722	0,6	BR9EVX	1265	208	BR9EIX		3981
Furax 50	50	95 -	B8HS	5510	0,5	B8HVX	2634	205	BR8HIX		7001
GP Serie Air Cool	50		BR10ES	4832	0,6	BR10EVX	3788			BR10EIX	6801
GP1 Replica water Cool	50	03 -	BR10ES	4832	0,6	BR10EVX	3788			BR10EIX	6801
Hunter	50		B8HS	5510	0,6	B8HVX	2634	205	BR8HIX		7001
Manhattan	50		B8HS	5510	0,6	B8HVX	2634	205	BR8HIX		7001
Paddock LC	50		B9ES	2611	0,6	B9EVX	7254	202	BR9EIX		3981
Paddock 50 O2	50		B8HS	5510	0,6	B8HVX	2634	205	BR8HIX		7001
Predator O2 (ES)	50		B8HS	5510	0,6	B8HVX	2634	205	BR8HIX		7001









					Order No.		Platin 	Order No.	Quick-No.	Iridium 	Order No.
DERBI											
Predator 02	50	98 -	B9ES	2611	0,6	B9EVX	7254	202	BR9EIX	3981	
Predator LC	50	98 -	B9ES	2611	0,6	B9EVX	7254	202	BR9EIX	3981	
Racing Replica	50	02 -	BR9ES	5722	0,6	BR9EVX	1265	208	BR9EIX	3981	
Red Bullet	50	03 -	BR9ES	5722	0,6	BR9EVX	1265	208	BR9EIX	3981	
Vamos SE 50	50		BR8HS	4322	0,6	BR8HVX	6265	212	BR8HIX	7001	
Vamos FL 50	50		BR8HS	4322	0,6	BR8HVX	6265	212	BR8HIX	7001	
Vamos 50	50	93 -	B8HS	5510	0,5	B8HVX	2634	205	BR8HIX	7001	
Variant Revolution	50	03 -	B8HS	5510	0,6	B8HVX	2634	205	BR8HIX	7001	
Atlantis 100	100		B9ES	2611	0,6	B9EVX	7254	202	BR9EIX	3981	
Boulevard 125 4T air cooler	125		CR9E	6263	0,7	CR9EVX	5943	227	CR9EIX	3521	
Boulevard 150 4T	150		CR9E	6263	0,7	CR9EVX	5943	227	CR9EIX	3521	
ENDRESS											
EMR 50 DJ	50	97 -	BR8HSA	5539	0,6	BR8HVX	6265		BR8HIX	7001	
EMR 50 Ergon	50	97 -	BP6HS	4511	0,6	BP6HVX	4635		BPR6HIX	4085	
ENDRESS EMR											
EMR 50	50		BR8HSA	5539	0,6	BR8HVX	6265		BR8HIX	7001	
ENFIELD											
Scooter	125		B6HS	4510	0,5	B6HVX	7435	203	BR6HIX	3419	
ERING											
Cat 50	50		B6HS	4510	0,6	B6HVX	7435	203	BR6HIX	3419	
Jet 50	50		B6HS	4510	0,6	B6HVX	7435	203	BR6HIX	3419	
Rapido	50		B6HS	4510	0,6	B6HVX	7435	203	BR6HIX	3419	
Silver Fox	50		B6HS	4510	0,6	B6HVX	7435	203	BR6HIX	3419	
Thunderbike 50	50		B6HS	4510	0,6	B6HVX	7435	203	BR6HIX	3419	
Cat 125	125		CR7HSA	4549	0,6	---			CR7HIX	7544	
Shining 125	125		CR7HSA	4549	0,6	---			CR7HIX	7544	
Thunderbike 125	125		CR7HSA	4549	0,6	---			CR7HIX	7544	
FAMEL-ZÜNDAPP											
Yuppie, XF	50		B8ES	2411	0,6	B8EVX	7051	201	BR8EIX	5044	
FANTIC											
Grinta	50		BP7HS	5111	0,6	BP7HVX	7468		BPR7HIX	5944	
Queenie	50		BP7HS	5111	0,6	BP7HVX	7468		BPR7HIX	5944	
Koala,Oasis	75		B8ES	2411	0,5	B8EVX	7051	201	BR8EIX	5044	
Caballero RC80	80		---		0,6	B10EG	3630				
GARELLI											
GS-1			BR8HSA	5539	0,6	BR8HVX	6265		BR8HIX	7001	
XM-1			BR8HSA	5539	0,6	BR8HVX	6265		BR8HIX	7001	
303 50	50		BPR7HS	6422	0,6	BPR7HVX	2938	215	BPR7HIX	5944	
Astro 50	50		BR9HS	4522	0,6	---			---		
Astro 50 2001	50	01 -	BR9HS	4522	0,6	---			---		
Big Whell	50	93 -	BPR7HS	6422	0,6	BPR7HVX	2938	215	BPR7HIX	5944	
Flo 50	50		BPR7HS	6422	0,6	BPR7HVX	2938	215	BPR7HIX	5944	
FX 50	50		BR9HS	4522	0,6	---			---		
Grinta 50	50	01.93 -	BP7HS	5111	0,6	BP7HVX	7468		BPR7HIX	5944	
Hussar 50	50		BR8HSA	5539	0,6	BR8HVX	6265		BR8HIX	7001	







					Order No.		Platin 	Order No.	Quick-No.	Iridium 	Order No.
GARELLI											
KRC 50	50		BR9HS	4522	0,6	---				---	
KRS 50	50		BR9HS	4522	0,6	---				---	
M 901 50	50		BR9HS	4522	0,6	---				---	
Mars 50	50		BR9HS	4522	0,6	---				---	
Match 50	50		BR8HSA	5539	0,6	BR8HVX	6265			BR8HIX	7001
PMX Rally 50	50		BPR7HS	6422	0,6	BPR7HVX	2938	215		BPR7HIX	5944
PMX Sport 50	50		BPR7HS	6422	0,6	BPR7HVX	2938	215		BPR7HIX	5944
Pony 50	50		BP7HS	5111	0,6	BP7HVX	7468			BPR7HIX	5944
Queenie 50	50	01.92 -	BP7HS	5111	0,6	BP7HVX	7468			BPR7HIX	5944
Racing SR / Racing	50	- 93	BP7HS	5111	0,6	BP7HVX	7468			BPR7HIX	5944
Raider 50	50		BR9HS	4522	0,6	---				---	
Roadshow 50	50		BR9HS	4522	0,6	---				---	
RZ1 50	50		BR9HS	4522	0,6	---				---	
Shark 50	50		BR9HS	4522	0,6	---				---	
SR	50		BP7HS	5111	0,6	BP7HVX	7468			BPR7HIX	5944
Starter 50	50		BR9HS	4522	0,6	---				---	
PMX Sport	106		BR8HS	4322	0,6	BR8HVX	6265	212		BR8HIX	7001
PMX Sport 110	110		BPR6HS	7022	0,6	BPR6HVX	2740	214		BPR6HIX	4085
303 R 125	125		CR7HSA	4549	0,5	---				CR7HIX	7544
Blast 125	125		CR7HSA	4549	0,5	---				CR7HIX	7544
GTA 125 / ES	125		B10ES	7928	0,5	B10EGV	5927			BR10EIX	6801
Hussar 125	125		CR7HSA	4549	0,6	---				CR7HIX	7544
Hussar 125 2001	125	01 -	CR7HSA	4549	0,6	---				CR7HIX	7544
Joker 125	125	03 -	CR7HSA	4549	0,7	---				CR7HIX	7544
Tiger 125 XLE	125		B10ES	7928	0,5	B10EGV	5927			BR10EIX	6801
T-Rex 125	125		CR7HSA	4549	0,6	---				CR7HIX	7544
T-Rex 150 2001	125		CR7HSA	4549	0,5	---				CR7HIX	7544
Freeland 150	150		CR7HSA	4549	0,7	---				CR7HIX	7544
Joker 150	150		CR7HSA	4549	0,7	---				CR7HIX	7544
T-Rex 150	150		CR7HSA	4549	0,5	---				CR7HIX	7544
T-Rex 150 2001	150	01 -	CR7HSA	4549	0,6	---				CR7HIX	7544
GILERA											
DNA 50	50	00 -	BR9ES	5722	0,6	BR9EVX	1265	208		BR9EIX	3981
Eaglet 50	50	01.93 -	B9ES	2611	0,6	B9EVX	7254	202		BR9EIX	3981
Easy Mooving	50	01.95 -	B9ES	2611	0,6	B9EVX	7254	202		BR9EIX	3981
GSM 50	50	00 -	BR9ES	5722	0,6	BR9EVX	1265	208		BR9EIX	3981
Ice	50	00 -	BR9ES	5722	0,6	BR9EVX	1265	208		BR9EIX	3981
Pure Jet 50	50	04 -	CPR8E	7411	0,6	---				---	
Runner	50	97 -	B9EG	3530	0,6	B9EGV	5827			---	
Runner 2P 2D	50	01.97 -	B9ES	2611	0,6	B9EVX	7254	202		BR9EIX	3981
Runner Racing Replica	50	04 -	BR9ES	5722	0,6	BR9EVX	1265	208		BR9EIX	3981
Runner SP	50	00 -	BR9ES	5722	0,6	BR9EVX	1265	208		BR9EIX	3981
Stalker	50	01.97 -	B9ES	2611	0,6	B9EVX	7254	202		BR9EIX	3981
Storm 50	50	94 -	B9ES	2611	0,5	B9EVX	7254	202		BR9EIX	3981
Typhoon 50	50	01.93 -	B9ES	2611	0,6	B9EVX	7254	202		BR9EIX	3981
Typhoon 50 Martini Racing	50	01.95 -	B9ES	2611	0,6	B9EVX	7254	202		BR9EIX	3981
Typhoon Benetton F1	50	01.96 -	B9ES	2611	0,6	B9EVX	7254	202		BR9EIX	3981
Cougar 125	125	00 -	DPR8EA-9	4929	0,9	DPR8EVX-9	2872	221		DPR8EIX-9	2202
DNA 125	125	00 -	CR8EB	7784	0,7	---				CR8EIX	4218
Runner FX 125	125	97 -	B9ES	2611	0,6	B9EVX	7254	202		BR9EIX	3981
Typhoon 125	125	01.95 -	B9ES	2611	0,6	B9EVX	7254	202		BR9EIX	3981









					Order No.		Platin 	Order No.	Quick-No.		Order No.
GILERA											
Runner	150	98 -	BR9ES	5722	0,6	BR9EVX	1265	208	BR9EIX	3981	
DNA 180	180	00 -	CR8EB	7784	0,7	---			CR8EIX	4218	
Runner FRX 180	180	98 -	B9ES	2611	0,6	B9EVX	7254	202	BR9EIX	3981	
Runner VRX	180	01 -	CR9EB	6955	0,6	---			CR9EIX	3521	
HMZ											
Cab SB50	50	96 -	BP6HS	4511	0,6	BP6HVX	4635		BPR6HIX	4085	
HONDA											
DIO 50	50	04 -	ER8EH-N		0,7						
Joker SRX50T	50	97 -	BR6HSA	4296	0,5	---			210	BR6HIX	3419
NB 50	50		BPR6HSA	4632	0,7	BPR6HVX	2740		214	BPR6HIX	4085
NB 50 M Melody (AB07)	50	84 -	BPR6HS	7022	0,7	BPR6HVX	2740		214	BPR6HIX	4085
NH 50 Lead	50	01.87 - 88	BPR6HS	7022	0,6	BPR6HVX	2740		214	BPR6HIX	4085
NH 50 M	50	93 -	BPR6HS	7022	0,7	BPR6HVX	2740		214	BPR6HIX	4085
NH 50 MS Lead (AF01)	50	85 - 87	BPR6HS	7022	0,7	BPR6HVX	2740		214	BPR6HIX	4085
PK 50 Wallaro	50	90 -	BR6HSA	4296	0,6	---			210	BR6HIX	3419
PX 50	50	89 - 90	BPR5HS	6222	0,6	---					
SA 50 Vision	50	91 -	BPR6HSA	4632	0,6	BPR6HVX	2740		214	BPR6HIX	4085
SA 50 Vision	50	01.88 - 90	BPR6HSA	4632	0,6	BPR6HVX	2740		214	BPR6HIX	4085
SFX 50	50	95 -	BR6HSA	4296	0,6	---			210	BR6HIX	3419
SGX 50 Sky	50	97 -	BR6HSA	4296	0,6	---			210	BR6HIX	3419
SH 50 T	50	96 -	BR6HSA	4296	0,6	---			210	BR6HIX	3419
SH 50 (AF40)	50	97 -	BR6HSA	4296	0,7	---			210	BR6HIX	3419
SH 50 (I)	50	01.87 - 96	BPR6HS	7022	0,6	BPR6HVX	2740		214	BPR6HIX	4085
SH 50 P	50	01.93 - 95	BPR6HSA	4632	0,6	BPR6HVX	2740		214	BPR6HIX	4085
SH 50 New	50	01.97 -	BPR6HS	7022	0,6	BPR6HVX	2740		214	BPR6HIX	4085
Shadow 50	50	01.97 -	BR6HSA	4296	0,6	---			210	BR6HIX	3419
SJ 50 Bali	50		BR6HSA	4296	0,6	---			210	BR6HIX	3419
Sky 50 DX	50	01.96 -	BR6HSA	4296	0,6	---			210	BR6HIX	3419
SXR 50 W	50	98 -	BR6HSA	4296	0,6	---			210	BR6HIX	3419
SZX 50 X8R-S/X	50	98 -	BR6HSA	4296	0,6	---			210	BR6HIX	3419
X8R-S	50	01.98 -	BR6HSA	4296	0,6	---			210	BR6HIX	3419
X8R-X	50	01.98 -	BR6HSA	4296	0,6	---			210	BR6HIX	3419
Zoomer	50	04 -	ER8EH-N								
NH 80 MS Lead (HD01)	80	83 -	BPR6HS	7022	0,7	BPR6HVX	2740		214	BPR6HIX	4085
SRX 90 Shadow (JH2 HF09A)	90	98 -	BR6HSA	4296	0,7	---			210	BR6HIX	3419
SCV 100 Lead	100	03 -	CR6HSA	2983	0,7	---				CR6HIX	7274
SH 100 T	100	01.96 -	BR6HSA	4296	0,6	---			210	BR6HIX	3419
SJ 100 Bali	100	01.96 -	BR6HSA	4296	0,6	---			210	BR6HIX	3419
@ 125	125	00 -	CR8EH-9	5666	0,9	CR8EHVX-9	4546		228	CR8EHIX-9	3797
CH 125	125	01.86 - 95	DPR7EA-9	5129	0,9	DPR7EVX-9	7682		220	DPR7EIX-9	7803
CH 125 P	125	-01.93	DPR7EA-9	5129	0,9	DPR7EVX-9	7682		220	DPR7EIX-9	7803
Dylan 125	125	02 -	CR8EH-9	5666	0,9	CR8EHVX-9	4546		228	CR8EHIX-9	3797
FES 125 Pantheon (JF05) 2Takt	125	98 -	BR8ES	5422	0,7	BR8EVX	1262		207	BR8EIX	5044
FES 125 Pantheon 4Takt	125	03 -	CR8EH-9	5666	0,9	CR8EHVX-9	4546		228	CR8EHIX-9	3797
NH 125 D Lead	125	83 -	BPR6HS	7022	0,7	BPR6HVX	2740		214	BPR6HIX	4085
Pantheon 125	125	01.98 -	BR8ES	5422	0,7	BR8EVX	1262		207	BR8EIX	5044
SH 125	125	01 -	CR8EH-9	5666	0,9	CR8EHVX-9	4546		228	CR8EHIX-9	3797
Spacy CH 125 (JS03)	125	97 -	DPR7EA-9	5129	0,9	DPR7EVX-9	7682		220	DPR7EIX-9	7803
CN 250	250	01.86 -	DPR6EA-9	5531	0,9	---			---		
CN 250 Fusion	250		DPR8EA-9	4929	0,9	DPR8EVX-9	2872		221	DPR8EIX-9	2202





				Order No.		Platin 	Order No.	Quick-No. 	Iridium 	Order No.
HONDA										
CN 250 Helix (MF02)	250	01.87 - 99	DPR6EA-9	5531	0,9	---			---	
FES 250 Foresight (MF04)	250	97 -	DPR7EA-9	5129	0,9	DPR7EVX-9	7682	220	DPR7EIX-9	7803
Foresight 250 (I)	250	01.98 -	DPR7EA-9	5129	0,9	DPR7EVX-9	7682	220	DPR7EIX-9	7803
Silver Wing ABS (G2)	600	03 -	CR8EH-9	5666	0,9	CR8EHVX-9	4546	228	CR8EHIIX-9	3797
Silver Wing 600	600	01 -	CR8EH-9	5666	0,9	CR8EHVX-9	4546	228	CR8EHIIX-9	3797
HYOSUNG										
Avanti 50 (SD50)	50	99 -	BP6HS	4511	0,6	BP6HVX	4635		BPR6HIX	4085
Cab 50 (SB50G)	50	95 -	BP6HS	4511	0,6	BP6HVX	4635		BPR6HIX	4085
Gamma 50 (SB50G)	50	97 -	BP6HS	4511	0,6	BP6HVX	4635		BPR6HIX	4085
Prima	50		BR8HSA	5539	0,6	BR8HVX	6265		BR8HIX	7001
Sense	50		BP6HS	4511	0,6	BP6HVX	4635		BPR6HIX	4085
SF 50	50	99 -	BR8HSA	5539	0,6	BR8HVX	6265		BR8HIX	7001
SF Rally 50	50	04 -	BR8HSA	5539	0,6	BR8HVX	6265		BR8HIX	7001
Supercab (EZ100)	100	97 -	BP7HS	5111	0,6	BP7HVX	7468		BP7HIX	5944
Boomer 125	125	02 -	DR8EA	7162	0,6	DR8EVX	6354		DR8EIX	6681
Grand Prix	125		DR8EA	7162	0,6	DR8EVX	6354		DR8EIX	6681
Plus 125	125		DR8EA	7162	0,6	DR8EVX	6354		DR8EIX	6681
ITALJET										
Ascot 50	50		BP7HS	5111	0,6	BP7HVX	7468		BPR7HIX	5944
Bazooka - Bazooka II	50		BP7HS	5111	0,6	BP7HVX	7468		BPR7HIX	5944
Cruise	50		BP6HS	4511	0,6	BP6HVX	4635		BPR6HIX	4085
Dragster 50	50	96 - 97	BPR8HS	3725	0,6	---			BPR8HIX	6742
Dragster 50	50	97 - 98	BPR8HS	3725	0,6	---			BPR8HIX	6742
Dragster	50	98 -	B7HS	5110	0,6	B7HVX	7836	204	BR7HIX	7067
Dragster 50	50	98 -	BR8HS	4322	0,6	BR8HVX	6265	212	BR8HIX	7001
Fastboy	50	98 -	BR7HS	4122	0,6	---		211	BR7HIX	7067
Formula 50 Mofa (aircool)	50	99 -	BR8HS	4322	0,6	BR8HVX	6265	212	BR8HIX	7001
Formula 50 watercool	50	98 -	BR8HS	4322	0,6	BR8HVX	6265	212	BR8HIX	7001
Formula 50 aircool	50	98 -	BR7HS	4122	0,6	---		211	BR7HIX	7067
Formula 50	50	01.95 -	BPR6HS	7022	0,6	BPR6HVX	2740	214	BPR6HIX	4085
Pista 50 ; Pista II	50		BP7HS	5111	0,6	BP7HVX	7468		BPR7HIX	5944
Reporter	50		BP7HS	5111	0,6	BP7HVX	7468		BPR7HIX	5944
Scoop 50	50		BP7HS	5111	0,6	BP7HVX	7468		BPR7HIX	5944
Sunny 50	50		BP6HS	4511	0,6	BP6HVX	4635		BPR6HIX	4085
Torpedo 2T	50		B7HS	5110	0,6	B7HVX	7836	204	BR7HIX	7067
Torpedo 50	50	98 -	BR7HS	4122	0,6	---		211	BR7HIX	7067
Torpedo 25	50	97 -	BPR8HS	3725	0,6	---			BPR8HIX	6742
Torpedo 4T	50		CR7E	4578	0,6	---		225	CR7EIX	7385
Velocifero	50	- 97	BPR6HS	7022	0,7	BPR6HVX	2740	214	BPR6HIX	4085
Velocifero "8", "10"	50	98 -	BR8HS	4322	0,6	BR8HVX	6265	212	BR8HIX	7001
Yankee 50	50		BP7HS	5111	0,6	BP7HVX	7468		BPR7HIX	5944
Millenium 100	100		BR7HS	4122	0,6	---			BR7HIX	7067
Dragster 125	125	97 - 97	B7HS	5110	0,6	B7HVX	7836	204	BR7HIX	7067
Dragster 125	125	98 -	BR9ES	5722	0,6	BR9EVX	1265	208	BR9EIX	3981
Formula 125 (I)	125		BR7HS	4122	0,6	---		211	BR7HIX	7067
Formula 125	125	97 - 98	B7HS	5110	0,6	B7HVX	7836	204	BR7HIX	7067
Formula 125	125	98 -	BR8HS	4322	0,6	BR8HVX	6265	212	BR8HIX	7001
Jet Set	125		CR7E	4578	0,6	---		225	CR7EIX	7385
Jupiter	125		CR8E	1275	0,7	CR8EVX	6487	226	CR8EIX	4218
Millenium	125	99 -	CR8E	1275	0,7	CR8EVX	6487	226	CR8EIX	4218







					Order No.		Platin 	Order No.	Quick-No.	Iridium 	Order No.
ITALJET											
Torpedo 125 4T	125	98 -	CR7E	4578	0,7	---		225	CR7EIX		7385
Jet Set	150		CR7E	4578	0,6	---		225	CR7EIX		7385
Jupiter	150		CR8E	1275	0,7	CR8EVX	6487	226	CR8EIX		4218
Millenium	150		CR8E	1275	0,7	CR8EVX	6487	226	CR8EIX		4218
Dragster 180	180	98 -	BR9ES	5722	0,6	BR9EVX	1265	208	BR9EIX		3981
Jupiter	250		DR8EA	7162	0,6	DR8EVX	6354		DR8EIX		6681
Millenium	250	99 -	DR8EA	7162	0,6	DR8EVX	6354		DR8EIX		6681
ITTECO											
Hornet	50		BP6HS	4511	0,6	BP6HVX	4635		BPR6HIX		4085
KINETIC											
Pride	50		BP7HS	5111	0,6	BP7HVX	7468		BPR7HIX		5944
Pride	80		BP7HS	5111	0,6	BP7HVX	7468		BPR7HIX		5944
KREIDLER											
Flory 25	25	96 -	BPR7HS	6422	0,6	BPR7HVX	2938	215	BPR7HIX		5944
Florett XL 25	50		BPR7HS	6422	0,6	BPR7HVX	2938	215	BPR7HIX		5944
Florett 25	50	01.96 -	BPR7HS	6422	0,6	BPR7HVX	2938	215	BPR7HIX		5944
Florett XL 50	50		BPR7HS	6422	0,6	BPR7HVX	2938	215	BPR7HIX		5944
Florett 50	50	01.96 -	BPR7HS	6422	0,6	BPR7HVX	2938	215	BPR7HIX		5944
Flory 50	50	96 -	BPR7HS	6422	0,6	BPR7HVX	2938	215	BPR7HIX		5944
MK	50	96 -	BPR7HS	6422	0,6	BPR7HVX	2938	215	BPR7HIX		5944
Flory 125	125		CR7HSA	4549	0,5	---			CR7HIX		7544
Mustang	125	97 -	CR7HSA	4549	0,5	---			CR7HIX		7544
KTM											
Chrono 50	50		BR7HS	4122	0,5	---		211	BR7HIX		7067
Go 50	50		BR7HS	4122	0,5	---		211	BR7HIX		7067
K 50 (I)	50		BR7HS	4122	0,5	---		211	BR7HIX		7067
KYMCO											
Calypso 50	50	97 -	BR8HS	4322	0,6	BR8HVX	6265	212	BR8HIX		7001
Cobra Cross	50	97 -	BR8HSA	5539	0,6	BR8HVX	6265		BR8HIX		7001
Cobra Racer	50	97 -	BR8HSA	5539	0,6	BR8HVX	6265		BR8HIX		7001
CSX 50	50		BR8HSA	5539	0,6	BR8HVX	6265		BR8HIX		7001
Curio	50		BR8HSA	5539	0,6	BR8HVX	6265		BR8HIX		7001
CX 50; CX Super	50		BR8HSA	5539	0,6	BR8HVX	6265		BR8HIX		7001
Dink 50 LC /Bet&Win 50LC	50		BR6HSA	4296	0,6			210	BR6HIX		3419
Dink 50 2Takt (Italy)	50	99 -	CR7HSA	4549	0,5	---			CR7HIX		7544
DJ 50	50		BR8HSA	5539	0,6	BR8HVX	6265		BR8HIX		7001
DJW 50 :W / X / Y	50	01.93 -	BR8HSA	5539	0,6	BR8HVX	6265		BR8HIX		7001
Fever II ZX 50	50		BR8HSA	5539	0,6	BR8HVX	6265		BR8HIX		7001
Fever ZX 50	50		BR8HSA	5539	0,6	BR8HVX	6265		BR8HIX		7001
Filly 50	50	98 -	C7HSA	4629	0,7	C7HVX	4533		CR7HIX		7544
Grand Dink 50 2Takt	50	05 -	BR8HSA	5539	0,6	BR8HVX	6265		BR8HIX		7001
Heroism 50	50		BR8HSA	5539	0,6	BR8HVX	6265		BR8HIX		7001
K 12 50	50		BR8HSA	5539	0,6	BR8HVX	6265		BR8HIX		7001
KB 50	50		BR8HSA	5539	0,6	BR8HVX	6265		BR8HIX		7001
People 50	50	99 -	BR8HSA	5539	0,6	BR8HVX	6265		BR8HIX		7001
Scout	50	97 -	BR8HSA	5539	0,6	BR8HVX	6265		BR8HIX		7001
Sniper 50	50	01.93 -	BR8HSA	5539	0,6	BR8HVX	6265		BR8HIX		7001







					Order No.		Platin 	Order No.	Quick-No. 	Iridium 	Order No.
KYMCO											
Snuper 50 DD	50		BR8HSA	5539	0,6	BR8HVX	6265			BR8HIX	7001
Spacer 50	50	99 -	BR8HSA	5539	0,6	BR8HVX	6265			BR8HIX	7001
Super 9 LC	50	01 -	BR8HSA	5539	0,6	BR8HVX	6265			BR8HIX	7001
Super 9 AC	50	01 -	BR8HSA	5539	0,6	BR8HVX	6265			BR8HIX	7001
Tomos Classic;Quadro;Flexer	50	01 -	B6HS	4510	0,6	B6HVX	7435	203		BR6HIX	3419
Top Boy 50	50	01 -	BR8HSA	5539	0,6	BR8HVX	6265			BR8HIX	7001
Vitality 50 4Takt	50	05 -	CR7HSA	4549	0,5	---				CR7HIX	7544
Vitality 50 2Takt	50	05 -	BR8HSA	5539	0,6	BR8HVX	6265			BR8HIX	7001
Yager 50 2Takt	50	01 -	BR8HSA	5539	0,6	BR8HVX	6265			BR8HIX	7001
YUP 50	50	00 -	BR8HSA	5539	0,6	BR8HVX	6265			BR8HIX	7001
Cobra Racer 100	100	99 -	BR8HSA	5539	0,6	BR8HVX	6265			BR8HIX	7001
Calypto 125	125	97 -	C7HSA	4629	0,6	C7HVX	4533			CR7HIX	7544
CK 125	125	05 -	DR8EA	7162	0,6	DR8EVX	6354			DR8EIX	6681
Dink 125 4Takt	125	99 -	DPR7EA-9	5129	0,9	DPR7EVX-9	7682	220		DPR7EIX-9	7803
Grand Dink 125 4Takt	125	99 -	DPR7EA-9	5129	0,9	DPR7EVX-9	7682	220		DPR7EIX-9	7803
Heroism 125	125		C7HSA	4629	0,7	C7HVX	4533			CR7HIX	7544
Hipster 125 4 Ventiler	125		CR8E	1275	0,7	CR8EVX	6487	226		CR8EIX	4218
Hipster 125 2 Ventiler	125	01 -	DR8EA	7162	0,7	DR8EVX	6354			DR8EIX	6681
Movie 125 4Takt	125		C7HSA	4629	0,6	C7HVX	4533			CR7HIX	7544
Pulsar 125	125	01 -	DR8EA	7162	0,7	DR8EVX	6354			DR8EIX	6681
Spacer	125	97 -	DPR7EA-9	5129	0,6	DPR7EVX-9	7682	220		DPR7EIX-9	7803
Spacer 125	125		DPR7EA-9	5129	0,9	DPR7EVX-9	7682	220		DPR7EIX-9	7803
Yager 125 4Takt	125	01 -	DPR7EA-9	5129	0,9	DPR7EVX-9	7682	220		DPR7EIX-9	7803
Zing	125	97 -	DR8EA	7162	0,6	DR8EVX	6354			DR8EIX	6681
Heroism	150		C7HSA	4629	0,7	C7HVX	4533			CR7HIX	7544
Dink 250 4Takt	250	99 -	DPR7EA-9	5129	0,9	DPR7EVX-9	7682	220		DPR7EIX-9	7803
Grand Dink 250 4Takt	250	99 -	DPR7EA-9	5129	0,9	DPR7EVX-9	7682	220		DPR7EIX-9	7803
People 250	250	05 -	DPR7EA-9	5129	0,9	DPR7EVX-9	7682	220		DPR7EIX-9	7803
Xciting 500	500	05 -	CR8E	1275	0,7	CR8EVX	6487	226		CR8EIX	4218
K-ZWO											
Cat 50	50	97 -	BR7HS	4122	0,6	---		211		BR7HIX	7067
K-zwo VIVA 50/25	50		BR7HS	4122	0,5	---		211		BR7HIX	7067
Motron Sting	50		BR7HS	4122	0,5	---		211		BR7HIX	7067
Motron Thunder	50		BR7HS	4122	0,5	---		211		BR7HIX	7067
Siamoto Falkon	50		C7HSA	4629	0,6	C7HVX	4533			CR7HIX	7544
Siamoto Scross	50		C7HSA	4629	0,6	C7HVX	4533			CR7HIX	7544
K-Zwo Appache	125		D8EA	2120	0,6	D8EVX	2850	216		DR8EIX	6681
K-Zwo Royal 125	125	96 -	C7HSA	4629	0,6	C7HVX	4533			CR7HIX	7544
Royal 125	125	96 -	C7HSA	4629	0,6	C7HVX	4533			CR7HIX	7544
LECSON											
LTS 50 BW	50		BP6HS	4511	0,6	BP6HVX	4635			BPR6HIX	4085
LTS 50 TR	50		BP6HS	4511	0,6	BP6HVX	4635			BPR6HIX	4085
LEM											
Flash (I)	50		BR7HS	4122	0,6	---		211		BR7HIX	7067
Ghibli (I)	50		BR7HS	4122	0,6	---		211		BR7HIX	7067
LML-VESPA											
NV 125 SPL	125		BP8ES	2912	0,6	BP8EVX	2671				
NV 150 SPL	150		BP8ES	2912	0,6	BP8EVX	2671				







					Order No.		Platin 	Order No.	Quick-No.	Iridium 	Order No.
LML- VESPA											
NV 200 SPL	200		B5ES	6410	0,6	---					
MACAL											
GTX	50	98 -	BR7HS	4122	0,6	---			211	BR7HIX	7067
MY 50	50	99 -	BR7HS	4122	0,6	---			211	BR7HIX	7067
New Star	50	98 -	BR7HS	4122	0,6	---			211	BR7HIX	7067
Star Flight	50	98 -	BR7HS	4122	0,6	---			211	BR7HIX	7067
Trophy	50	98 -	BR8ES	5422	0,6	BR8EVX	1262	207	211	BR8EIX	5044
MALAGUTI											
Centro SL 50	50		BR7HS	4122	0,6	---			211	BR7HIX	7067
Centro SL	50	93 -	BR7HS	4122	0,5	---			211	BR7HIX	7067
Centro	50	00 -	BR8HS	4322	0,5	BR8HVX	6265	212	212	BR8HIX	7001
Centro 50	50	01.92 -	BR7HS	4122	0,6	---			211	BR7HIX	7067
Ciak	50		BR8HS	4322	0,5	BR8HVX	6265	212	212	BR8HIX	7001
CR 1	50	10.95 -	BPR6HS	7022	0,5	BPR6HVX	2740	214	214	BPR6HIX	4085
Crosser CR1 50	50		BPR6HS	7022	0,6	BPR6HVX	2740	214	214	BPR6HIX	4085
ET	50		B6HS	4510	0,6	B6HVX	7435	203	203	BR6HIX	3419
F-10 Jet Line Tigers 50	50		BR7HS	4122	0,6	---			211	BR7HIX	7067
F-10	50	93 -	BR7HS	4122	0,5	---			211	BR7HIX	7067
F-10 Jetline	50	00 -	BR8HS	4322	0,5	BR8HVX	6265	212	212	BR8HIX	7001
F-10 Jetline WAP	50	03 -	BR7HS	4122	0,6	---			211	BR7HIX	7067
F-10 Jet Line 50	50	01.92 -	BR7HS	4122	0,6	---			211	BR7HIX	7067
F-11	50		BR8HS	4322	0,5	BR8HVX	6265	212	212	BR8HIX	7001
F-12 Phantom	50		BR7HS	4122	0,6	---			211	BR7HIX	7067
F-12 LC	50		BR7HS	4122	0,5	---			211	BR7HIX	7067
F-12 Phantom	50		BR7HS	4122	0,5	---			211	BR7HIX	7067
F-12 Phantom LC dd	50	00 -	BR8HS	4322	0,5	BR8HVX	6265	212	212	BR8HIX	7001
F-12 Phantom AC	50	00 -	BR8HS	4322	0,5	BR8HVX	6265	212	212	BR8HIX	7001
F-12 Phantom 3 AC	50	03 -	BR7HS	4122	0,6	---			211	BR7HIX	7067
F-15 Firefox	50	97 -	BR8HS	4322	0,5	BR8HVX	6265	212	212	BR8HIX	7001
F-15 Firefox 50	50	01.96 -	BR8HS	4322	0,6	BR8HVX	6265	212	212	BR8HIX	7001
Grizzly RXC 10	50		BR6HS	3922	0,5	---			209	BR6HIX	3419
Grizzly RXC 12	50		BR8HS	4322	0,5	BR8HVX	6265	212	212	BR8HIX	7001
Phantom LC Tiger 50	50	01.93 -	BR7HS	4122	0,6	---			211	BR7HIX	7067
Yesterday	50	97 -	BR8HS	4322	0,6	BR8HVX	6265	212	212	BR8HIX	7001
Ciak 125 4Takt	125		CR7HSA	4549	0,7	---				CR7HIX	7544
Madison	125		CR8E	1275	0,7	CR8EVX	6487	226	226	CR8EIX	4218
Ciak 150 4Takt	150		CR7HSA	4549	0,7	---				CR7HIX	7544
F-12 Phantom Max 200	200	04 -	CR8EB	7784	0,6	---				CR8EIX	4218
Madison S 200	200	03 -	CR8EB	7784	0,6	---				CR8EIX	4218
Madison S250	250		DR8EA	7162	0,7	DR8EVX	6354			DR8EIX	6681
Madison 400	400	03 -	CR9E	6263	0,7	CR9EVX	5943	227	227	CR9EIX	3521
Spidermax 500 GT	500	04 -	CR7EKB	4455	0,6	---				---	
MARS											
MK 50/1	50		BP6HS	4511	0,6	BP6HVX	7465			BPR6HIX	4085
SM 50	50		BP7HS	5111	0,6	BP7HVX	7468			BPR7HIX	5944
SM 50/1	50		BP7HS	5111	0,6	BP7HVX	7468			BPR7HIX	5944
MBK											
Active 50 (I)	50		BR7HS	4122	0,6	---			211	BR7HIX	7067







					Order No.		Platin 	Order No.	Quick-No. 	Iridium 	Order No.			
MBK														
Booster (4FG) (CH)					50		BR8HS	4322	0,5	BR8HVX	6265	212	BR8HIX	7001
Booster R 50 (I)					50		BR7HS	4122	0,6	---		211	BR7HIX	7067
Booster (3TX) (GB)					50		BPR7HS	6422	0,5	BPR7HVX	2938	215	BPR7HIX	5944
Booster Spirit 50 (I)					50		BR8HS	4322	0,6	BR8HVX	6265	212	BR8HIX	7001
Booster N.G. 50 (I)					50		BR8HS	4322	0,6	BR8HVX	6265	212	BR8HIX	7001
Booster		93 -			50		BR7HS	4122	0,5	---		211	BR7HIX	7067
Booster Rocket (CW50RSP)		97 -			50		BR8HS	4322	0,6	BR8HVX	6265	212	BR8HIX	7001
Booster (CW50)		97 -			50		BR8HS	4322	0,6	BR8HVX	6265	212	BR8HIX	7001
Booster Track (CW50RSX)		97 -			50		BR8HS	4322	0,6	BR8HVX	6265	212	BR8HIX	7001
Booster NG (CW50RS)		97 -			50		BR8HS	4322	0,6	BR8HVX	6265	212	BR8HIX	7001
Booster 50 (I)		01.90 -	94		50		BPR7HS	6422	0,6	BPR7HVX	2938	215	BPR7HIX	5944
CT 50 S - CT 50 SS (I)					50		BP7HS-10	7829	0,6	---				
Evolis (4HU) (NL)					50		BR6HS	3922	0,5	---		209	BR6HIX	3419
Evolis (4FW)		93 -			50		BR7HS	4122	0,5	---		211	BR7HIX	7067
Evolis 50 (YE50)		97 -			50		BR8HS	4322	0,6	BR8HVX	6265	212	BR8HIX	7001
Evolis 50 (I)		01.92 -			50		BR7HS	4122	0,6	---		211	BR7HIX	7067
Fizz		-	96		50		BR8HS	4322	0,5	BR8HVX	6265	212	BR8HIX	7001
Fizz (YM50)		97 -			50		BR8HS	4322	0,6	BR8HVX	6265	212	BR8HIX	7001
Fizz 50 (I)		01.94 -			50		BR7HS	4122	0,6	---		211	BR7HIX	7067
Flipper					50		BR8HS	4322	0,6	BR8HVX	6265	212	BR8HIX	7001
Forte (3UG)		96 -			50		BR8HS	4322	0,6	BR8HVX	6265	212	BR8HIX	7001
Forte (YA50R)		97 -			50		BR7HS	4122	0,5	---		211	BR7HIX	7067
Forte 50 (I)		01.94 -			50		BR7HS	4122	0,6	---		211	BR7HIX	7067
Mach G					50		BR8HS	4322	0,6	BR8HVX	6265	212	BR8HIX	7001
Mach G LC 50					50		BR8HS	4322	0,6	BR8HVX	6265	212	BR8HIX	7001
New Sorriso 50 (I)		01.95 -			50		BP7HS	5111	0,6	BP7HVX	7468		BPR7HIX	5944
Nitro		97 -			50		BR8HS	4322	0,6	BR8HVX	6265	212	BR8HIX	7001
Ovetto		01.97 -			50		BR7HS	4122	0,6	---		211	BR7HIX	7067
Sorriso 50 (I)					50		BP7HS-10	7829	0,6	---				
Stunt 50		03 -			50		BR8HS	4322	0,6	BR8HVX	6265	212	BR8HIX	7001
Target 50 (I)					50		BP7HS	5111	0,6	BP7HVX	7468		BPR7HIX	5944
Evolis (4MU)(YE80)		96 -			80		BR7HS	4122	0,7	---		211	BR7HIX	7067
Zest (4MU)					80		BR7HS	4122	0,7	---		211	BR7HIX	7067
Nitro 100					100		BR8HS	4322	0,6	BR8HVX	6265	212	BR8HIX	7001
Ovetto 100					100		BR8HS	4322	0,6	BR8HVX	6265	212	BR8HIX	7001
Flame (4NB)					125		CR7E	4578	0,6	---		225	CR7EIX	7385
Flame (XC125R)					125		CR7E	4578	0,6	---		225	CR7EIX	7385
Flame (XC125T)					125		CR7E	4578	0,6	---		225	CR7EIX	7385
Doodo 4T					125		CR8E	1275	0,7	CR8EVX	6487	226	CR8EIX	4218
Skyliner		98 -			125		CR8E	1275	0,7	CR8EVX	6487	226	CR8EIX	4218
Thunder 125 4T					125		CR8E	1275	0,7	CR8EVX	6487	226	CR8EIX	4218
XC 125 Flame (I)		-	94		125		CR6HSA	2983	0,7	---			CR6HIX	7274
XC 125 Flame (I)		01.95 -			125		CR7E	4578	0,7	---		225	CR7EIX	7385
Vertex 150 (I)					150		CR7E	4578	0,7	---		225	CR7EIX	7385
MOTRON														
Spike (I)					50		BR7HS	4122	0,6	---		211	BR7HIX	7067
Sting 50 (I)					50		BR7HS	4122	0,6	---		211	BR7HIX	7067
Sting 50		96 -			50		BR7HS	4122	0,6	---		211	BR7HIX	7067
Syncro (I)					50		BR7HS	4122	0,6	---		211	BR7HIX	7067
Thunder S 50 (I)					50		BR7HS	4122	0,6	---		211	BR7HIX	7067
Thunder 50		96 -			50		BR7HS	4122	0,6	---		211	BR7HIX	7067







				Order No.		Platin 	Order No.	Quick-No.	Iridium 	Order No.
MZ										
Moskito FB 50	50	97 -	BR7HS	4122	0,6	---		211	BR7HIX	7067
Moskito 50 SX (CPI50C)	50	99 -	BR7HS	4122	0,6	---		211	BR7HIX	7067
Moskito 50 RX (EG Country)	50	02 -	BR8HSA	5539	0,6	BR8HVX	6265		BR8HIX	7001
Moskito 50RX (not EG Country)	50	02 -	BPR6HS	7022	0,6	BPR6HVX	2740	214	BPR6HIX	4085
Moskito 125	125	01 -	CR7HSA	4549	0,6	---			CR7HIX	7544
OTTO										
Fashion 50	50	96 -	BR8HSA	5539	0,6	BR8HVX	6265		BR8HIX	7001
GTX 50	50	96 -	BR7HS	4122	0,6	---		211	BR7HIX	7067
PEGASUS										
Corona 25	50		BPR7HS	6422	0,5	BPR7HVX	2938	215	BPR7HIX	5944
Corona 50	50		BPR7HS	6422	0,5	BPR7HVX	2938	215	BPR7HIX	5944
Skiper 25	50		BPR7HS	6422	0,5	BPR7HVX	2938	215	BPR7HIX	5944
Skiper 50	50		BPR7HS	6422	0,5	BPR7HVX	2938	215	BPR7HIX	5944
Sky 25	50		BPR7HS	6422	0,5	BPR7HVX	2938	215	BPR7HIX	5944
Sky 25 High Wheels	50		BPR7HS	6422	0,5	BPR7HVX	2938	215	BPR7HIX	5944
Sky 50	50		BPR7HS	6422	0,5	BPR7HVX	2938	215	BPR7HIX	5944
Sky 50 High Wheels	50		BPR7HS	6422	0,5	BPR7HVX	2938	215	BPR7HIX	5944
Solero 25	50		BPR7HS	6422	0,5	BPR7HVX	2938	215	BPR7HIX	5944
Solero 50	50		BPR7HS	6422	0,5	BPR7HVX	2938	215	BPR7HIX	5944
Corona 125 Sport Edition	125		CR7HSA	4549	0,6	---			CR7HIX	7544
Corona 125 Comfort Edition	125		CR7HSA	4549	0,6	---			CR7HIX	7544
Skiper 125	125		CR7HSA	4549	0,7	---			CR7HIX	7544
Sky 125	125		CR7HSA	4549	0,7	---			CR7HIX	7544
PEUGEOT										
Buxi 50; Road (I)	50		B7HS	5110	0,6	B7HVX	7836	204	BR7HIX	7067
Buxy	50		B7HS	5110	0,6	B7HVX	7836	204	BR7HIX	7067
Eliséo 50	50	98 -	BR7HS	4122	0,7	---		211	BR7HIX	7067
Elystar 50	50		CPR8E	7411	0,6	---			---	
Jet Force 50	50	03.03 -	CPR8E	7411	0,6	---			---	
Looxor Vergaser	50	01 -	BR7HS	4122	0,6	---		211	BR7HIX	7067
Looxor 50 TSDI	50		CPR8E	7411	0,6	---			---	
Ludix Blaster	50	04 -	BR7HS	4122	0,7	---		211	BR7HIX	7067
Ludix Classic	50	04 -	BR7HS	4122	0,6	---		211	BR7HIX	7067
Ludix Elegance	50	04 -	BR7HS	4122	0,6	---		211	BR7HIX	7067
Ludix One	50	04 -	BR7HS	4122	0,7	---		211	BR7HIX	7067
Ludix Snake	50	04 -	BR7HS	4122	0,7	---		211	BR7HIX	7067
Ludix Tend	50	04 -	BR7HS	4122	0,7	---		211	BR7HIX	7067
Metal-X 50	50		BR7HS	4122	0,6	---		211	BR7HIX	7067
Rapido	50		BP6HS	4511	0,6	BP6HVX	4635		BPR6HIX	4085
Speedake	50		B7HS	5110	0,6	B7HVX	7836	204	BR7HIX	7067
Speedake 50	50		B7HS	5110	0,6	B7HVX	7836	204	BR7HIX	7067
Speedfight	50		BR8HS	4322	0,6	BR8HVX	6265	212	BR8HIX	7001
Speedfight 2 50 AC / LC	50		BR7HS	4122	0,7	---		211	BR7HIX	7067
Speedfight LC	50	96 -	BR7HS	4122	0,6	---		211	BR7HIX	7067
Speedfight M	50	96 -	BR7HS	4122	0,6	---		211	BR7HIX	7067
Speedfight AC Air	50	98 -	BR7HS	4122	0,7	---		211	BR7HIX	7067
Speedfight LC " Prost X Team " Watercool	50	98 -	BR7HS	4122	0,7	---		211	BR7HIX	7067
Squab	50	96 -	BR8HS	4322	0,5	BR8HVX	6265	212	BR8HIX	7001
Squab 50 (I)	50		BR8HS	4322	0,6	BR8HVX	6265	212	BR8HIX	7001







				Order No.		Platin 	Order No.	Quick-No. 	Iridium 	Order No.
PEUGEOT										
ST 50 (I)	50		B7HS	5110	0,5	B7HVX	7836	204	BR7HIX	7067
ST 50; Metropolis (I)	50		B7HS	5110	0,6	B7HVX	7836	204	BR7HIX	7067
SV 50	50	- 95	B8HS	5510	0,6	B8HVX	2634	205	BR8HIX	7001
SV 50	50	96 -	BR8HS	4322	0,6	BR8HVX	6265	212	BR8HIX	7001
SV 50 Geo (I)	50		B8HS	5510	0,6	B8HVX	2634	205	BR8HIX	7001
SV 50 Junior	50		B8HS	5510	0,6	B8HVX	2634	205	BR8HIX	7001
TKR Streetboard 50 / WRC	50	00 -	BR7HS	4122	0,6	---		211	BR7HIX	7067
Trekker (I)	50		BR8HS	4322	0,6	BR8HVX	6265	212	BR8HIX	7001
Trekker Road	50		BR7HS	4122	0,6	---		211	BR7HIX	7067
Trekker Off Road	50	98 -	BR7HS	4122	0,6	---		211	BR7HIX	7067
Vivacity 50	50	99 -	BR7HS	4122	0,7	---		211	BR7HIX	7067
Zenith 50 (I)	50		B7HS	5110	0,5	B7HVX	7836	204	BR7HIX	7067
Zenith 50; F.D. (I)	50		B7HS	5110	0,6	B7HVX	7836	204	BR7HIX	7067
Zenith F.D. 50 (I)	50		B7HS	5110	0,5	B7HVX	7836	204	BR7HIX	7067
Zenith LM2	50	96 -	BR8HS	4322	0,5	BR8HVX	6265	212	BR8HIX	7001
SV 80	80		B8HS	5510	0,6	B8HVX	2634	205	BR8HIX	7001
Eliséo 100	100	98 -	BR8ES	5422	0,7	BR8EVX	1262	207	BR8EIX	5044
Looxor 100	100	02.01 -	BR8ES	5422	0,6	BR8EVX	1262	207	BR8EIX	5044
Speedfight 100	100	96 - 03	BR8ES	5422	0,6	BR8EVX	1262	207	BR8EIX	5044
Speedfight 2 100	100	03 -	BR8ES	5422	0,6	BR8EVX	1262	207	BR8EIX	5044
SV 100	100	96 -	BR8ES	5422	0,6	BR8EVX	1262	207	BR8EIX	5044
TKR 100	100	00 -	BR8ES	5422	0,6	BR8EVX	1262	207	BR8EIX	5044
Trekker 100	100	98 -	BR8ES	5422	0,6	BR8EVX	1262	207	BR8EIX	5044
Vivacity 100	100	99 -	BR8ES	5422	0,7	BR8EVX	1262	207	BR8EIX	5044
Eliséo 125	125	98 -	CR8E	1275	0,7	CR8EVX	6487	226	CR8EIX	4218
Eliséo Advantage 125	125	04 -	CR8E	1275	0,7	CR8EVX	6487	226	CR8EIX	4218
Elystar 125	125		CR8E	1275	0,7	CR8EVX	6487	226	CR8EIX	4218
Jet Force 125	125	03.03 -	CR7EB	4663	0,6	---			---	
Looxor 125	125		CR7EB	4663	0,6	---			---	
Ludix 125	125	04 -	CR7EB	4663	0,6	---			---	
Satelis 125	125	04 -	CR7EB	4663	0,6	---			---	
SV 125	125		BP6HS	4511	0,6	BP6HVX	4635		BPR6HIX	4085
SV 125; Metropolis (I)	125		BP6HS	4511	0,6	BP6HVX	4635		BPR6HIX	4085
Elyseo 150	150	00 -	CR8E	1275	0,7	CR8EVX	6487	226	CR8EIX	4218
Elystar 150	150		CR7E	4578	0,7			225	CR7EIX	7385
Looxor 150	150		CR7EB	4663	0,6	---			---	
SV 250	250	01 -	DPR7EA-9	5129	0,9	DPR7EVX-9	7682	220	DPR7EIX-9	7803
PGO										
Big Max 25/50	50		BPR7HS	6422	0,5	BPR7HVX	2938	215	BPR7HIX	5944
Big Max 50	50		BPR7HS	6422	0,5	BPR7HVX	2938	215	BPR7HIX	5944
Big Max Sport 50	50	96 -	BP7HS	5111	0,6	BP7HVX	7468		BPR7HIX	5944
Comet	50		BP7HS	5111	0,6	BP7HVX	7468		BPR7HIX	5944
Galaxy 50	50		BP7HS	5111	0,6	BP7HVX	7468		BPR7HIX	5944
Galaxy 25	50		BP7HS	5111	0,6	BP7HVX	7468		BPR7HIX	5944
Mega 50	50	96 -	BPR7HS	6422	0,5	BPR7HVX	2938	215	BPR7HIX	5944
New Galaxy 50 (I)	50		BP6HS	4511	0,6	BP6HVX	4635		BPR6HIX	4085
PMS 50	50	99 -	BP7HS	5111	0,6	BP7HVX	7468		BPR7HIX	5944
PMX 50	50	99 -	BP7HS	5111	0,6	BP7HVX	7468		BPR7HIX	5944
Rodoshow	50	02.00 -	BP7HS	5111	0,6	BP7HVX	7468		BPR7HIX	5944
Star 2	50		BP7HS	5111	0,6	BP7HVX	7468		BPR7HIX	5944
Star 50	50		BP6HS	4511	0,6	BP6HVX	4635		BPR6HIX	4085







					Order No.		Platin 	Order No.	Quick-No.	Iridium 	Order No.
PGO											
Super Comet 50 (I)	50		BP7HS	5111	0,6	BP7HVX	7468			BPR7HIX	5944
Tornado 50	50	97 -	BPR7HS	6422	0,5	BPR7HVX	2938	215		BPR7HIX	5944
T-REX 50	50	99 -	BP7HS	5111	0,6	BP7HVX	7468			BPR7HIX	5944
Star 80	80		BP6HS	4511	0,6	BP6HVX	4635			BPR6HIX	4085
Big Max 90	82	96 -	BPR7HS	6422	0,5	BPR7HVX	2938	215		BPR7HIX	5944
Galaxy 90	90		BPR7HS	6422	0,6	BPR7HVX	2938	215		BPR7HIX	5944
Tornado 1.25	125	97 -	BPR7HS	6422	0,5	BPR7HVX	2938	215		BPR7HIX	5944
T-REX 125 2T	125	99 -	BP7HS	5111	0,6	BP7HVX	7468			BPR7HIX	5944
T-REX 125 4T	125	99 -	C7HSA	4629	0,6	C7HVX	4533			CR7HIX	7544
T-REX 150 4T	150	03 -	C7HSA	4629	0,6	C7HVX	4533			CR7HIX	7544
PIAGGIO											
Free 25 Mofa	25		BP8ES	2912	0,5	BP8EVX	2671				
Zip 25 Mofa	25		BPR8ES	3923	0,5	BPR8EVX	5573				
Zip Base 25 / Mofa	25		BPR8ES	3923	0,5	BPR8EVX	5573				
50 R, Special	50		B6HS	4510	0,5	B6HVX	7435	203		BR6HIX	3419
50 S	50		B6HS	4510	0,5	B6HVX	7435	203		BR6HIX	3419
Boss	50		B6HS	4510	0,6	B6HVX	7435	203		BR6HIX	3419
Boss	50		B6HS	4510	0,5	B6HVX	7435	203		BR6HIX	3419
Bravo P	50		BR6HS	3922	0,7	---		209		BR6HIX	3419
Bravo - Si / Moped	50		B5HS	4210	0,5	---					
Bravo PV	50		BR6HS	3922	0,7	---		209		BR6HIX	3419
Ciao M Kat	50		BR6HS	3922	0,7	---		209		BR6HIX	3419
Ciao Mix / Mix	50		B5HS	4210	0,5	---					
Ciao V Kat	50		BR6HS	3922	0,7	---		209		BR6HIX	3419
Ciao-Bravo Si / Mofa	50		B5HS	4210	0,5	---					
Diesis 50	50		BR9ES	5722	0,7	BR9EVX	1265	208		BR9EIX	3981
Eaglet	50		B9ES	2611	0,5	B9EVX	7254	202		BR9EIX	3981
ET2 (iniezione / Einspritzer)	50	98 -	---		0,6	DCPR9EVX	6436				
Free Kat	50		BR9ES	5722	0,7	BR9EVX	1265	208		BR9EIX	3981
Free 50	50	93 -	B9ES	2611	0,5	B9EVX	7254	202		BR9EIX	3981
Free Business 50	50	01.96 -	B9ES	2611	0,6	B9EVX	7254	202		BR9EIX	3981
Grillo / Mofa	50		B5HS	4210	0,5	---					
Liberty Kat	50		BR9ES	5722	0,7	BR9EVX	1265	208		BR9EIX	3981
Liberty 4T	50	02 -	CR9EB	6955	0,8	---				CR9EIX	3521
Liberty	50	01.97 -	B9ES	2611	0,6	B9EVX	7254	202		BR9EIX	3981
NRG Extreme Kat	50		B9ES	2611	0,5	B9EVX	7254	202		BR9EIX	3981
NRG H ² O Kat	50		B9ES	2611	0,5	B9EVX	7254	202		BR9EIX	3981
NRG Extreme	50		B9ES	2611	0,5	B9EVX	7254	202		BR9EIX	3981
NRG	50		B9ES	2611	0,5	B9EVX	7254	202		BR9EIX	3981
NRG mc2 DT,DD	50		B9ES	2611	0,5	B9EVX	7254	202		BR9EIX	3981
NRG mc3 Pure Jet	50	02 -	CPR8E	7411	0,6	---				---	
NRG 50	50	01.94 -	B9ES	2611	0,6	B9EVX	7254	202		BR9EIX	3981
NRG mc2 50	50	01.96 -	B9EG	3530	0,6	B9EGV	5827			---	
NSP 4T (Aria)	50	02 -	CR9EB	6955	0,8	---				CR9EIX	3521
NTT 50	50	01.95 -	B9ES	2611	0,6	B9EVX	7254	202		BR9EIX	3981
PK 50 S Auto	50		BR7ES	5122	0,5	BR7EVX	4556				
PK 50 SS	50		B7HS	5110	0,5	B7HVX	7836	204		BR7HIX	7067
PK 50 XL2 Auto	50		B8ES	2411	0,5	B8EVX	7051	201		BR8EIX	5044
PK 50 XL 2	50		BR7HS	4122	0,6	---		211		BR7HIX	7067
PK 50 S	50	09.82 -12.87	B6HS	4510	0,5	B6HVX	7435	203		BR6HIX	3419
PK 50	50	09.82 -12.87	B6HS	4510	0,5	B6HVX	7435	203		BR6HIX	3419







				Order No.		Platin 	Order No.	Quick-No. 	Iridium	Order No.
PIAGGIO										
Plurimatic	50		B6HS	4510	0,5	B6HVX	7435	203	BR6HIX	3419
PX 50	50		B6HS	4510	0,5	B6HVX	7435	203	BR6HIX	3419
Quarz 50	50	01.92 -	B9ES	2611	0,6	B9EVX	7254	202	BR9EIX	3981
Quarz 50 Automatic	50	06.92 -	B9ES	2611	0,5	B9EVX	7254	202	BR9EIX	3981
Rush	50		BR7HS	4122	0,6	---		211	BR7HIX	7067
Sfera 50 , FL, RL, RST	50		B9ES	2611	0,5	B9EVX	7254	202	BR9EIX	3981
Sfera 50	50	01.90 -	B9ES	2611	0,6	B9EVX	7254	202	BR9EIX	3981
Sfera 50 Automatico	50	01.91 -	B9ES	2611	0,5	B9EVX	7254	202	BR9EIX	3981
Sfera RL 50	50		B9ES	2611	0,6	B9EVX	7254	202	BR9EIX	3981
Skipper	50		BR9ES	5722	0,6	BR9EVX	1265	208	BR9EIX	3981
Storm Automatic	50	94 -	B9ES	2611	0,5	B9EVX	7254	202	BR9EIX	3981
Super Bravo / Mofa	50		B5HS	4210	0,5	---				
Super Bravo 2 Gang / Mofa	50		B5HS	4210	0,5	---				
TPH	50	93 -	B9ES	2611	0,5	B9EVX	7254	202	BR9EIX	3981
Typhoon air / X 50	50	01.96 -	BR9ES	5722	0,7	BR9EVX	1265	208	BR9EIX	3981
Velofax / Mofa	50		BP8ES	2912	0,6	BP8EVX	2671			
Velofax 50	50	01.95 -	B8ES	2411	0,5	B8EVX	7051	201	BR8EIX	5044
Velofax 50 AE	50	01.95 -	B8ES	2411	0,5	B8EVX	7051	201	BR8EIX	5044
Vespa HP 4M	50		B6HS	4510	0,5	B6HVX	7435	203	BR6HIX	3419
Vespa Elestart	50		B6HS	4510	0,5	B6HVX	7435	203	BR6HIX	3419
Vespa PK 50 XL 2 ,Automatic	50		B8ES	2411	0,5	B8EVX	7051	201	BR8EIX	5044
Vespa Delta Puch Condor	50		B7HS	5110	0,5	B7HVX	7836	204	BR7HIX	7067
Vespa Vale Especial/Standard	50		B5HS	4210	0,5	---				
Vespa ET3 Primavera	50		BR7HS	4122	0,6	---		211	BR7HIX	7067
Vespa ET2 IE	50		---			DCPR9EVX	6436		---	
Vespa ET 4	50	02 -	CR9EB	6955	0,8	---			CR9EIX	3521
Vespa 50 HP 4M	50	01.93 -	B7HS	5110	0,5	B7HVX	7836	204	BR7HIX	7067
Vespino NX/SC/T/TL/TN/TS	50		BR7HS	4122	0,6	---		211	BR7HIX	7067
Vespino TX/XE	50		BR7HS	4122	0,6	---		211	BR7HIX	7067
Vespino	50		BR7HS	4122	0,6	---		211	BR7HIX	7067
Zip Base 50	50		B9ES	2611	0,5	B9EVX	7254	202	BR9EIX	3981
Zip 4 4T	50		CR7E	4578	0,6	---		225	CR7EIX	7385
Zip 50 SP	50		---		0,5	B9EG	3530			
Zip Kat	50		BPR8ES	3923	0,5	BPR8EVX	5573			
Zip 50 RST	50		B9ES	2611	0,6	B9EVX	7254	202	BR9EIX	3981
Zip 50	50	01.92 -	B9ES	2611	0,6	B9EVX	7254	202	BR9EIX	3981
Zip 50 Fast Rider	50	01.93 -	B9ES	2611	0,6	B9EVX	7254	202	BR9EIX	3981
Zip 50 SP	50	01.96 -	B9ES	2611	0,6	B9EVX	7254	202	BR9EIX	3981
Zip water	50	01.96 -	B10ES	7928	0,7	B10EVX	7335		BR10EIX	6801
Zip air	50	01.96 -	BR9ES	5722	0,7	BR9EVX	1265	208	BR9EIX	3981
Zip & Zip (Hybrid)	50	94 -	B9ES	2611	0,5	B9EVX	7254	202	BR9EIX	3981
Zip & Zip 50 4 T Aria	50	02 -	CR9EB	6955	0,8	---			CR9EIX	3521
Zip & Zip 50	50	01.94 -	B9ES	2611	0,6	B9EVX	7254	202	BR9EIX	3981
SKR City	75		BR9ES	5722	0,6	BR9EVX	1265	208	BR9EIX	3981
Vespa PK 75XL/ Elestart	75		B9ES	2611	0,6	B9EVX	7254	202	BR9EIX	3981
Vespa PK 75S/ Elestart/ Junior	75		B7HS	5110	0,5	B7HVX	7836	204	BR7HIX	7067
Vespa PK 75S Primavera / T3 Prima.	75		B7HS	5110	0,5	B7HVX	7836	204	BR7HIX	7067
PK 80 S	80	09.82 -12.85	BR7HS	4122	0,6	---		211	BR7HIX	7067
PX 80 E Lusso	80		B6ES	7310	0,5	B6EVX	5136			
PX 80 E, P 80 X	80		B6ES	7310	0,5	B6EVX	5136			
Sfera 80 Automatic	80		B9ES	2611	0,5	B9EVX	7254	202	BR9EIX	3981
Skipper	80		B9ES	2611	0,6	B9EVX	7254	202	BR9EIX	3981







					Order No.		Platin 	Order No.	Quick-No.	Iridium 	Order No.
PIAGGIO											
TPH Automatic	80	94 -	B9ES	2611	0,5	B9EVX	7254	202	BR9EIX	3981	
Typhoon	80		BR9ES	5722	0,6	BR9EVX	1265	208	BR9EIX	3981	
Diesis 100	100	01 -	CR8EB	7784	0,6	---			CR8EIX	4218	
Free 100	100	02 -	CR8EB	7784	0,6	---			CR8EIX	4218	
PK 100 S	100	06.82 -	BR7HS	4122	0,6	---		211	BR7HIX	7067	
125 T5	125	03.85 -	B8ES	2411	0,6	B8EVX	7051	201	BR8EIX	5044	
Ape	125		B7HS	5110	0,5	B7HVX	7836	204	BR7HIX	7067	
Beverly 125	125	02 -	CR8EB	7784	0,6	---			CR8EIX	4218	
Cosa 125	125	- 91	B8ES	2411	0,5	B8EVX	7051	201	BR8EIX	5044	
Cosa 200 FL EBC 12PS	125		B8ES	2411	0,5	B8EVX	7051	201	BR8EIX	5044	
Cosa FL 125	125	91 -	B9ES	2611	0,5	B9EVX	7254	202	BR9EIX	3981	
Cosa 125 MA AE	125	01.88 -	B9ES	2611	0,6	B9EVX	7254	202	BR9EIX	3981	
ET 3	125		BR7HS	4122	0,6	---		211	BR7HIX	7067	
ET 4 Automatic	125		CR7EB	4663	0,6	---			---		
Gandturismo	125	-04.04	CR9EB	6955	0,6	---			CR9EIX	3521	
Hexagon LX 4Takt 2V Air	125		CR7EB	4663	0,6	---			---		
Hexagon LX 4T / 4V H2O watercooler	125		CR8EB	7784	0,6	---			CR8EIX	4218	
Hexagon LX 125	125	94 -	B9ES	2611	0,5	B9EVX	7254	202	BR9EIX	3981	
Liberty 125	125		CR7E	4578	0,6	---		225	CR7EIX	7385	
Liberty 4Takt	125		CR7EB	4663	0,6	---			---		
P 125 ETS	125	01.83 -12.85	BR7HS	4122	0,6	---		211	BR7HIX	7067	
PK 125 XL 2	125		B8ES	2411	0,5	B8EVX	7051	201	BR8EIX	5044	
PK 125 XL Automatic	125		BR7HS	4122	0,6	---		211	BR7HIX	7067	
PK 125, E, S	125		BR6HS	3922	0,5	---		209	BR6HIX	3419	
PK Automatic	125		B7HS	5110	0,5	B7HVX	7836	204	BR7HIX	7067	
Primavera	125	01.76 -12.83	BR7HS	4122	0,6	---		211	BR7HIX	7067	
PX 125 E Lusso	125	01.82 -	B6HS	4510	0,5	B6HVX	7435	203	BR6HIX	3419	
Sfera RL 125 - 4Takt	125		CR9E	6263	0,6	CR9EVX	5943	227	CR9EIX	3521	
Sfera RST 4 Takt	125	95 -	CR7E	4578	0,6	---		225	CR7EIX	7385	
Sfera 125	125	01.95 -	CR9E	6263	0,6	CR9EVX	5943	227	CR9EIX	3521	
Skipper 125 LX	125	01.93 -	B9ES	2611	0,6	B9EVX	7254	202	BR9EIX	3981	
Skipper 125 4 Takt	125	00 -	CR7EB	4663	0,6	---			---		
SKR 125	125	08.93 -	B9ES	2611	0,5	B9EVX	7254	202	BR9EIX	3981	
Super Hexagon GTX 125 4Takt	125	01 -	CR8EB	7784	0,6	---			CR8EIX	4218	
TPH	125	95 -	B9ES	2611	0,5	B9EVX	7254	202	BR9EIX	3981	
Vespa Special ET3 Primavera	125		B7HS	5110	0,6	B7HVX	7836	204	BR7HIX	7067	
Vespa T3Li/T3	125		B6HS	4510	0,5	B6HVX	7435	203	BR6HIX	3419	
Vespa Special ET4 Carburatore	125		CR8EB	7784	0,6	---			CR8EIX	4218	
Vespa XL 125 Plurimat/Elestart	125		B7HS	5110	0,6	B7HVX	7836	204	BR7HIX	7067	
Vespa 125 T5 Sport/Elestart	125		B9ES	2611	0,6	B9EVX	7254	202	BR9EIX	3981	
Vespa 125 CL/LS/NK Primavera	125		B6HS	4510	0,5	B6HVX	7435	203	BR6HIX	3419	
Vespa PX 125 Kat	125		B9ES	2611	0,5	B9EVX	7254	202	BR9EIX	3981	
Vespa T5	125		B9ES	2611	0,5	B9EVX	7254	202	BR9EIX	3981	
Vespa PK 125	125	85 -	BR7HS	4122	0,6	---		211	BR7HIX	7067	
Vespa PX 125 MA AE	125	86 -	B6HS	4510	0,5	B6HVX	7435	203	BR6HIX	3419	
Vespa ET4	125	99 -	CR7EB	4663	0,6	---			---		
Vespa GT	125	03 -	CR8EB	7784	0,6	---			CR8EIX	4218	
Vespa 125 FL2	125	01.90 -	B7HS	5110	0,6	B7HVX	7836	204	BR7HIX	7067	
Vespa ET4 125	125	01.96 -	CR8EB	7784	0,7	---			CR8EIX	4218	
Vespa PX 125 MA AE	125	01.96 -	B6HS	4510	0,6	B6HVX	7435	203	BR6HIX	3419	
X 9 11kW	125	-04.02	CR9EB	6955	0,6	---			CR9EIX	3521	
X 9 11kW	125	05.02 -	CR8EB	7784	0,6	---			CR8EIX	4218	







				Order No.		Gold-Palladium		Platin	Order No.	Quick-No.		Iridium	Order No.
PIAGGIO													
Zip 125	125		CR9EB	6955	0,6	---					CR9EIX	3521	
Cosa	150		BR9ES	5722	0,6	BR9EVX	1265	208	BR9EIX	3981			
EX 150 (Hexagon)	150	94 -	B9ES	2611	0,5	B9EVX	7254	202	BR9EIX	3981			
Hexagon 150	150	01.94 -	B9ES	2611	0,6	B9EVX	7254	202	BR9EIX	3981			
Liberty	150		CR7EB	4663	0,6	---			---				
PX 150 E Lusso	150	01.82 -	B6HS	4510	0,5	B6HVX	7435	203	BR6HIX	3419			
Skipper ST 150 4Takt	150	- 00	BR9ES	5722	0,7	BR9EVX	1265	208	BR9EIX	3981			
Skipper 150	150	01.93 -	B9ES	2611	0,6	B9EVX	7254	202	BR9EIX	3981			
Skipper ST 4T	150	01 -	CR7EB	4663	0,6	---			---				
SKR 150	150	98 -	B9ES	2611	0,5	B9EVX	7254	202	BR9EIX	3981			
Vespa 150 long 12,7 mm	150		B6HS	4510	0,5	B6HVX	7435	203	BR6HIX	3419			
Vespa 150 long 19,0 mm	150		B6ES	7310	0,5	B6EVX	5136						
Vespa PX 150 Kat	150		BR6HS	3922	0,7	---		209	BR6HIX	3419			
Vespa 150 ET4	150	- 01	CR7E	4578	0,6	---		225	CR7EIX	7385			
Vespa PX 150 MA AE	150	86 -	B6HS	4510	0,5	B6HVX	7435	203	BR6HIX	3419			
Vespa 150 ET4	150	01 - 02	CR8EB	7784	0,6	---			CR8EIX	4218			
Vespa 150 ET 4	150	02 -	CR7EB	4663	0,8	---			---				
Vespa PX 150 MA AE	150	01.96 -	B6HS	4510	0,6	B6HVX	7435	203	BR6HIX	3419			
Vespa 160/ GT	160		B6HS	4510	0,5	B6HVX	7435	203	BR6HIX	3419			
Vespa 175	175		B6HS	4510	0,5	B6HVX	7435	203	BR6HIX	3419			
Hexagon LXT 180	180	01.98 -	B9ES	2611	0,6	B9EVX	7254	202	BR9EIX	3981			
Super Hexagon LXT 180	180	01 -	CR8EB	7784	0,6	---			CR8EIX	4218			
Vespa SS	180		B6HS	4510	0,5	B6HVX	7435	203	BR6HIX	3419			
X 9 4T Amalfi	180	01 -	CR8EB	7784	0,6	---			CR8EIX	4218			
Ape	190		B7HS	5110	0,5	B7HVX	7836	204	BR7HIX	7067			
Cosa MA AE	200		BR8ES	5422	0,6	BR8EVX	1262	207	BR8EIX	5044			
Cosa FL 200	200	91 -	BR8ES	5422	0,6	BR8EVX	1262	207	BR8EIX	5044			
Cosa 200 Aluzyl.12PS	200	93 - 97	BR8ES	5422	0,6	BR8EVX	1262	207	BR8EIX	5044			
Beverly 200	200	01 -	CR8EB	7784	0,6	---			CR8EIX	4218			
Cosa 200 MA AE	200	01.88 -	BR8ES	5422	0,6	BR8EVX	1262	207	BR8EIX	5044			
Cosa 2 200	200	01.88 - 91	BR8ES	5422	0,6	BR8EVX	1262	207	BR8EIX	5044			
Cosa 2 200 MA AE	200	01.88 -	BR8ES	5422	0,6	BR8EVX	1262	207	BR8EIX	5044			
DN	200		BR7ES	5122	0,5	BR7EVX	4556						
DS	200		BR7ES	5122	0,5	BR7EVX	4556						
PE	200		BR7ES	5122	0,5	BR7EVX	4556						
PX 200 E Grand-Sport	200	01.84 -	BR7ES	5122	0,5	BR7EVX	4556						
PX 200 E Lusso	200	01.84 -	BR7ES	5122	0,5	BR7EVX	4556						
Vespa 200 TX/ Elestart	200		B7ES	1111	0,6	B7EVX	6934		---				
Vespa PX 200E/Iris/Iris Elestart	200		B7ES	1111	0,6	B7EVX	6934		---				
Vespa 200 DN/ DS/ E	200		B5ES	6410	0,5	---							
Vespa PX 200 MA AE	200	86 -	B6ES	7310	0,5	B6EVX	5136						
Vespa PX 200 MA AE	200	01.96 -	B6ES	7310	0,6	B6EVX	5136						
Vespa Rally	200		BR7ES	5122	0,5	BR7EVX	4556						
Ape	220		B7HS	5110	0,5	B7HVX	7836	204	BR7HIX	7067			
Hexagon GT 250 4Takt	250	98 -	DPR6EA-9	5531	0,9	---			---				
Super Hexagon GTX 250	250		CR9E	6263	0,7	CR9EVX	5943	227	CR9EIX	3521			
X 9 (4T)	250	00 - 03	DPR7EA-9	5129	0,9	DPR7EVX-9	7682	220	DPR7EIX-9	7803			
Beverly 500	500	03 -	CR7EKB	4455	0,6	---			---				
X 9 EVO (4T)	500	04 -	CR7EKB	4455	0,6	---			---				
X 9 (4T)	500	11.03 -	CR7EKB	4455	0,6	---			---				







					Order No.		Platin 	Order No.	Quick-No.	Iridium 	Order No.
PUCH											
Lido	50		BPR6HS	7022	0,7	BPR6HVX	2740	214	BPR6HIX	4085	
Lido 125	125		DR8ES	5423	0,7	DR8EVX	6354	217	DR8EIX	6681	
REX											
Rex 25	25		BPR7HS	6422	0,6	BPR7HVX	2938	215	BPR7HIX	5944	
Rexy 50	25	96 -	BPR7HS	6422	0,6	BPR7HVX	2938	215	BPR7HIX	5944	
Rexy 25	25	96 -	BPR7HS	6422	0,6	BPR7HVX	2938	215	BPR7HIX	5944	
Rex 50	50	96 -	BPR7HS	6422	0,6	BPR7HVX	2938	215	BPR7HIX	5944	
Scooter	50	96 -	BPR7HS	6422	0,6	BPR7HVX	2938	215	BPR7HIX	5944	
Silver Star	50		BPR7HS	6422	0,6	BPR7HVX	2938	215	BPR7HIX	5944	
Silver Street	50		BPR7HS	6422	0,6	BPR7HVX	2938	215	BPR7HIX	5944	
Rex 125	125	97 -	CR7HSA	4549	0,5	---			CR7HIX	7544	
Rexy 125	125		CR7HSA	4549	0,5	---			CR7HIX	7544	
RIEJU											
Drac 50 (AM5)	50	96 -	BR8ES	5422	0,6	BR8EVX	1262	207	BR8EIX	5044	
MRX 50 EURO (AM6)	50	02 -	BR9ES	5722	0,6	BR9EVX	1265	208	BR9EIX	3981	
MRX 50 Top (AM6)	50	03 -	BR9ES	5722	0,6	BR9EVX	1265	208	BR9EIX	3981	
MX 50 Infantil (Morini S5)	50	01 - 01	B6HS	4510	0,5	B6HVX	7435	203	BR6HIX	3419	
MX 50 Infantil (Morini S6)	50	02 -	B9ES	2611	0,6	B9EVX	7254	202	BR9EIX	3981	
NKD 50 (AM6)	50	03 -	BR9ES	5722	0,6	BR9EVX	1265	208	BR9EIX	3981	
RR 50 (AM5)	50	97 -	BR8ES	5422	0,6	BR8EVX	1262	207	BR8EIX	5044	
RR 50 (AM6)	50	01 -	BR8ES	5422	0,6	BR8EVX	1262	207	BR8EIX	5044	
RR 50 Castrol (AM6)	50	02 -	BR9ES	5722	0,6	BR9EVX	1265	208	BR9EIX	3981	
RR 50 EURO (AM6)	50	02 -	BR9ES	5722	0,6	BR9EVX	1265	208	BR9EIX	3981	
RS1 (AM5)	50	97 -	BR8ES	5422	0,6	BR8EVX	1262	207	BR8EIX	5044	
RS1 EVO (AM6)	50	98 -	BR8ES	5422	0,6	BR8EVX	1262	207	BR8EIX	5044	
RS1 EVO EURO (AM6)	50	02 -	BR9ES	5722	0,6	BR9EVX	1265	208	BR9EIX	3981	
RS2 Matrix (AM6)	50	03 -	BR9ES	5722	0,6	BR9EVX	1265	208	BR9EIX	3981	
SMX 50 EURO (AM6)	50	02 -	BR9ES	5722	0,6	BR9EVX	1265	208	BR9EIX	3981	
Windy (MY50)	50		BR7HS	4122	0,5	---		211	BR7HIX	7067	
MRX 125 (Yamaha)	125	02 -	CR7HSA	4549	0,6	---			CR7HIX	7544	
SMX 125 (Yamaha)	125	02 -	CR7HSA	4549	0,6	---			CR7HIX	7544	
RIVERO											
Linus 50	50		BPR7HS	6422	0,5	BPR7HVX	2938	215	BPR7HIX	5944	
ROYAL											
Royal 125	125	96 -	C7HSA	4629	0,6	C7HVX	4533		CR7HIX	7544	
SACHS											
Buxy (RS)	50		B7HS	5110	0,6	B7HVX	7836	204	BR7HIX	7067	
City Roller CV 50	50		BPR6HS	7022	0,7	BPR6HVX	2740	214	BPR6HIX	4085	
Limbo	50		BP6HS	4511	0,6	BP6HVX	4635		BPR6HIX	4085	
MadAss 50	50	04 -	CR7HSA	4549	0,6	---			CR7HIX	7544	
Reggae (RS)	50		B7HS	5110	0,6	B7HVX	7836	204	BR7HIX	7067	
Samba SR	50		B8HS	5510	0,5	B8HVX	2634	205	BR8HIX	7001	
Speedake	50		B7HS	5110	0,6	B7HVX	7836	204	BR7HIX	7067	
Speedfight 50 AC	50	97 -	BR7HS	4122	0,6	---		211	BR7HIX	7067	
Speedfight 50 LC	50	97 -	BR7HS	4122	0,6	---		211	BR7HIX	7067	
Speedfight 50 LC ADT	50	97 -	BR7HS	4122	0,6	---		211	BR7HIX	7067	
Splinter	50		B7HS	5110	0,6	B7HVX	7836	204	BR7HIX	7067	

					Order No.		Platin 	Order No.	Quick-No.	Iridium 	Order No.
SACHS											
Squab	50		BR8HS	4322	0,6	BR8HVX	6265	212	BR8HIX	7001	
SR 50	50		B8HS	5510	0,6	B8HVX	2634	205	BR8HIX	7001	
SV 50	50		B8HS	5510	0,6	B8HVX	2634	205	BR8HIX	7001	
SV 50 Junior	50		B8HS	5510	0,6	B8HVX	2634	205	BR8HIX	7001	
Zenith	50		BP6HS	4511	0,6	BP6HVX	4635		BPR6HIX	4085	
City Roller CV 80	80		BPR6HS	7022	0,7	BPR6HVX	2740	214	BPR6HIX	4085	
City Roller CV 80 E	80		BR8HS	4322	0,7	BR8HVX	6265	212	BR8HIX	7001	
SR 80	80		B8HS	5510	0,6	B8HVX	2634	205	BR8HIX	7001	
SV 80	80		B8HS	5510	0,6	B8HVX	2634	205	BR8HIX	7001	
SR 125	125		BP6HS	4511	0,6	BP6HVX	4635		BPR6HIX	4085	
SR 125 C	125		BP6HS	4511	0,6	BP6HVX	4635		BPR6HIX	4085	
Superduke	125	97 -	C7HSA	4629	0,6	C7HVX	4533		CR7HIX	7544	
SV 125	125		BP6HS	4511	0,6	BP6HVX	4635		BPR6HIX	4085	
SV 125 C	125		BP6HS	4511	0,6	BP6HVX	4635		BPR6HIX	4085	
SAN YANG											
Fancy 50	50	10.95 -	BR8HSA	5539	0,6	BR8HVX	6265		BR8HIX	7001	
Flash 50	50		BR8HSA	5539	0,6	BR8HVX	6265		BR8HIX	7001	
Free 50	50		BR8HSA	5539	0,6	BR8HVX	6265		BR8HIX	7001	
Jet 50	50		BR8HSA	5539	0,6	BR8HVX	6265		BR8HIX	7001	
Mike 50	50		BR8HSA	5539	0,6	BR8HVX	6265		BR8HIX	7001	
Pure 50	50		BR8HSA	5539	0,6	BR8HVX	6265		BR8HIX	7001	
Red Devil 50	50		BR8HSA	5539	0,6	BR8HVX	6265		BR8HIX	7001	
Super Fancy 50	50		BR8HSA	5539	0,6	BR8HVX	6265		BR8HIX	7001	
Duke 125	125		C7HSA	4629	0,6	C7HVX	4533		CR7HIX	7544	
Super Duke 125	125		C7HSA	4629	0,6	C7HVX	4533		CR7HIX	7544	
SASY											
Classic 200 E	50	96 -	BPR6HS	7022	0,5	BPR6HVX	2740	214	BPR6HIX	4085	
JC 50	50	96 -	C7HSA	4629	0,6	C7HVX	4533		CR7HIX	7544	
Jet 50	50	96 -	BPR6HS	7022	0,5	BPR6HVX	2740	214	BPR6HIX	4085	
Mulan B	50	96 -	BPR6HS	7022	0,5	BPR6HVX	2740	214	BPR6HIX	4085	
Mulan Super AG	50	96 -	BPR6HS	7022	0,5	BPR6HVX	2740	214	BPR6HIX	4085	
Standard 50	50	96 -	BPR6HS	7022	0,5	BPR6HVX	2740	214	BPR6HIX	4085	
SHE LUNG											
Club (I)	50		BP7HS	5111	0,6	BP7HVX	7468		BPR7HIX	5944	
Racer (I)	50		BP7HS	5111	0,6	BP7HVX	7468		BPR7HIX	5944	
SIAM											
Falkon 50	50	97 -	BR7HS	4122	0,6	---		211	BR7HIX	7067	
Scros (I)	50		BPR6HS	7022	0,6	BPR6HVX	2740	214	BPR6HIX	4085	
Scross	50		BPR6HS	7022	0,7	BPR6HVX	2740	214	BPR6HIX	4085	
SIAMOTO											
Birdie 25 Mofa	25	99 -	BPR6HS	7022	0,7	BPR6HVX	2740	214	BPR6HIX	4085	
Sross 50	50	99 -	BR7HS	4122	0,5	---		211	BR7HIX	7067	
Capri 125 4-Takt	125	99 -	C7HSA	4629	0,7	C7HVX	4533		CR7HIX	7544	
Favourite 125 4-Takt	125	99 -	C7HSA	4629	0,7	C7HVX	4533		CR7HIX	7544	
KD 125 4-Takt	125	99 -	C7HSA	4629	0,7	C7HVX	4533		CR7HIX	7544	

					Order No.		Platin 	Order No.	Quick-No.	Iridium 	Order No.
SIMSON											
City 2000	50	95 -	B8HS	5510	0,6	B8HVX	2634	205	BR8HIX	7001	
SR 50 (1B)	50		B8HS	5510	0,6	B8HVX	2634	205	BR8HIX	7001	
SR 50 (1XCE) Gamma	50		B8HS	5510	0,6	B8HVX	2634	205	BR8HIX	7001	
SR 50 (1XG) Gamma	50		B8HS	5510	0,6	B8HVX	2634	205	BR8HIX	7001	
Star 50	50	96 -	BPR6HS	7022	0,7	BPR6HVX	2740	214	BPR6HIX	4085	
Hot Summer 80	70	97 -	B9HS	5810	0,4	B9HVX	2254		---		
Star Classic 80	70	97 -	B9HS	5810	0,4	B9HVX	2254		---		
SR 80 /1B	80		B8HS	5510	0,6	B8HVX	2634	205	BR8HIX	7001	
SR 80 /1XCE	80		B8HS	5510	0,6	B8HVX	2634	205	BR8HIX	7001	
STEFFEN											
Steffi	50	98 -	BP6HS	4511	0,6	BP6HVX	4635		BPR6HIX	4085	
Steffi S	50	98 -	BP6HS	4511	0,6	BP6HVX	4635		BPR6HIX	4085	
SUNDIRO											
Speedy 50	50	96 -	---		0,6	B9EVX	7254				
Speedy 80	80		---		0,6	B9EVX	7254				
Phönix XDZ 125 T	125	96 -	CR7HSA	4549	0,6	---			CR7HIX	7544	
Phönix XDZ 125 TA	125	96 -	CR7HSA	4549	0,6	---			CR7HIX	7544	
SUZUKI											
Address (I)	50		BPR6HS	7022	0,6	BPR6HVX	2740	214	BPR6HIX	4085	
AH 50 (I)	50	01.92 -	BPR6HS	7022	0,6	BPR6HVX	2740	214	BPR6HIX	4085	
AH 50 Address (CA1GA)	50	92 -	BPR6HS	7022	0,7	BPR6HVX	2740	214	BPR6HIX	4085	
AH 50 GP	50	95 -	BPR6HS	7022	0,6	BPR6HVX	2740	214	BPR6HIX	4085	
AJ 50 ZZ (I)	50	95 -	BPR7HS	6422	0,5	BPR7HVX	2938	215	BPR7HIX	5944	
AP 50 S CA1JA)	50	95 -	BPR6HS	7022	0,6	BPR6HVX	2740	214	BPR6HIX	4085	
AP 50 T (I)	50	96 -	BPR6HS	7022	0,7	BPR6HVX	2740	214	BPR6HIX	4085	
AY Katana WRX/WR/W (AA)	50	97 -	BPR6HS	7022	0,6	BPR6HVX	2740	214	BPR6HIX	4085	
CP 50 (I)	50	89 - 92	BPR6HS	7022	0,7	BPR6HVX	2740	214	BPR6HIX	4085	
UF50 Estilete (WVBA)	50	00 -	BPR7HS	6422	0,6	BPR7HVX	2938	215	BPR7HIX	5944	
UX 50 W Zillion (AT)	50	99 -	BPR6HS	7022	0,7	BPR6HVX	2740	214	BPR6HIX	4085	
AH 100 (I)	100	- 93	BPR7HS	6422	0,6	BPR7HVX	2938	215	BPR7HIX	5944	
AH 100 (I)	100	- 93	BPR7HS	6422	0,5	BPR7HVX	2938	215	BPR7HIX	5944	
AH 100 (CE12A)	100	95 -	BPR7HS	6422	0,7	BPR7HVX	2938	215	BPR7HIX	5944	
AN 125 (CF42A)	125	95 - 95	CR8E	1275	0,7	CR8EVX	6487	226	CR8EIX	4218	
AN 125 (CF42A)	125	96 -	CR7E	4578	0,7	---		225	CR7EIX	7385	
AN 125 S (I)	125	95 -	CR8E	1275	0,7	CR8EVX	6487	226	CR8EIX	4218	
AN 125 T (I)	125	01.96 -	CR7E	4578	0,7	---		225	CR7EIX	7385	
UC 125 / U Epicuro (AX)	125	99 -	CR8E	1275	0,7	CR8EVX	6487	226	CR8EIX	4218	
UE 125 (WVBH)	125	01 -	CR7E	4578	0,7	---		225	CR7EIX	7385	
UH 125 (WVBP)	125	02 -	CR8E	1275	0,7	CR8EVX	6487	226	CR8EIX	4218	
AN 150 T (I)	150	01.96 -	CR7E	4578	0,7	---		225	CR7EIX	7385	
AN 250 Burgman (AN/WVAN)	250	05.98 -	CR8EK	3478	0,7	CR8EVX	6487		---		
AN 400 Burgman (AU/WVAU)(WVBU)	400	99 -	CR7E	4578	0,7	---		225	CR7EIX	7385	
AN 650 Burgmann 650 (K3)(K4)	650	03 -	CR8E	1275	0,7	CR8EVX	6487	226	CR8EIX	4218	
SYM											
DD 50	50		BR8HSA	5539	0,6	BR8HVX	6265		BR8HIX	7001	
Fancy	50	96 -	BR8HSA	5539	0,6	BR8HVX	6265		BR8HIX	7001	
Fiddle 50	50		BR8HSA	5539	0,6	BR8HVX	6265		BR8HIX	7001	
Flash	50	96 -	BR8HSA	5539	0,6	BR8HVX	6265		BR8HIX	7001	

				Order No.		Platin 	Order No.	Quick-No. 	Iridium 	Order No.
SYM										
Free	50	96 -	BR8HSA	5539	0,6	BR8HVX	6265		BR8HIX	7001
Jet	50	96 -	BR8HSA	5539	0,6	BR8HVX	6265		BR8HIX	7001
Mask 50	50		BR8HSA	5539	0,6	BR8HVX	6265		BR8HIX	7001
Pure 50	50	96 -	BR8HSA	5539	0,6	BR8HVX	6265		BR8HIX	7001
Red Devil	50		BR8HSA	5539	0,6	BR8HVX	6265		BR8HIX	7001
Shark 50	50		BR8HSA	5539	0,6	BR8HVX	6265		BR8HIX	7001
Super Fancy	50	96 -	BR8HSA	5539	0,6	BR8HVX	6265		BR8HIX	7001
HD 125	125	04 -	CR7HSA	4549	0,6	---			CR7HIX	7544
Joyride 125	125	03 -	CR7HSA	4549	0,6	---			CR7HIX	7544
Megalo 125	125		C7HSA	4629	0,7	C7HVX	4533		CR7HIX	7544
Shark 125	125	99 -	C7HSA	4629	0,7	C7HVX	4533		CR7HIX	7544
Super Duke 125	125	96 -	C7HSA	4629	0,7	C7HVX	4533		CR7HIX	7544
500 GT	500	04 -	CR7EKB	4455	0,6	---			---	
500 XP	500	04 -	CR7EKB	4455	0,6	---			---	
T.G.M. Bimota										
Akros 50	50		BP6HS	4511	0,7	BP6HVX	4635		BPR6HIX	4085
Ergon 50	50		BP6HS	4511	0,7	BP6HVX	4635		BPR6HIX	4085
TGB										
Bunny AS 50 X	50		BP6HS	4511	0,6	BP6HVX	4635		BPR6HIX	4085
KBX 50	50		BP6HS	4511	0,6	BP6HVX	4635		BPR6HIX	4085
TOKAIDO										
2000 K50	50	96 -	BR7HS	4122	0,6	---		211	BR7HIX	7067
50 V	50		BP7HS	5111	0,6	BP7HVX	7468		BPR7HIX	5944
SM 50	50		BP7HS	5111	0,6	BP7HVX	7468		BPR7HIX	5944
SM 50/1	50		BP7HS	5111	0,6	BP7HVX	7468		BPR7HIX	5944
VELOCIFERO										
Velocifero 50 (I)	50		B8HS	5510	0,6	B8HVX	2634	205	BR8HIX	7001
VESPA										
-> PIAGGIO										
VILLA BS										
Giorno 50 (I)	50		BR8HSA	5539	0,6	BR8HVX	6265		BR8HIX	7001
GP 50 Dio (I)	50		BPR8HS	3725	0,6	---			BPR8HIX	6742
SP 50 Dio (I)	50		BPR7HS	6422	0,6	BPR7HVX	2938	215	BPR7HIX	5944
Z5 50 (I)	50		BR8HSA	5539	0,6	BR8HVX	6265		BR8HIX	7001
ZX 50 (I)	50		BR8HSA	5539	0,6	BR8HVX	6265		BR8HIX	7001
VIVA										
Viva 50	50	96 -	BP7HS	5111	0,5	BP7HVX	7468		BPR7HIX	5944
WINKING										
Bunny AS / AT / AX	50		BP7HS	5111	0,7	BP7HVX	7468		BPR7HIX	5944
Bunny AS 50 X	50		BP6HS	4511	0,7	BP6HVX	4635		BPR6HIX	4085
Koala 2	50		B5HS	4210	0,6	---				
Koala LM	50		B6HS	4510	0,6	B6HVX	7435	203	BR6HIX	3419
Scooty Roller	50		B6HS	4510	0,6	B6HVX	7435	203	BR6HIX	3419

					Order No.		Platin 	Order No.	Quick-No.	Iridium 	Order No.	WP
Wave 50	50	96 -	BPR7HS	6422	0,5	BPR7HVX	2938	215		BPR7HIX		5944
YAMAHA												
Aerox	50	97 -	BR8HS	4322	0,6	BR8HVX	6265	212		BR8HIX		7001
Aerox Racing	50	04 -	BR8HS	4322	0,6	BR8HVX	6265	212		BR8HIX		7001
Aerox R Toyota Racing	50	03 -	BR8HS	4322	0,6	BR8HVX	6265	212		BR8HIX		7001
Axis (YA50R) (3UG)	50	97 -	BR8HS	4322	0,7	BR8HVX	6265	212		BR8HIX		7001
Axis 50 (I)	50	01.95 -	BR7HS	4122	0,6	---		211		BR7HIX		7067
Axis Mofa (5AK)(YA50R)	50	97 -	BR7HS	4122	0,7	---		211		BR7HIX		7067
Beluga (I)	50		BP7HS-10	7829	1,0	---						
Breeze (4RC)(YM50)	50	95 -	BR8HS	4322	0,7	BR8HVX	6265	212		BR8HIX		7001
Breeze 50 (I)	50	01.94 -	BR7HS	4122	0,6	---		211		BR7HIX		7067
BW S NG 99 (SA056)	50	99 -	BR8HS	4322	0,6	BR8HVX	6265	212		BR8HIX		7001
BW 50 Spy (CW50RSP;4VA)	50	96 -	BR8HS	4322	0,7	BR8HVX	6265	212		BR8HIX		7001
BW 50 (4BX)	50	91 - 95	BR7HS	4122	0,7	---		211		BR7HIX		7067
BW 50 (CW50)	50	96 -	BR8HS	4322	0,7	BR8HVX	6265	212		BR8HIX		7001
BW 50 Bump (CW50RSX)	50	96 -	BR8HS	4322	0,7	BR8HVX	6265	212		BR8HIX		7001
BW 50 NG (CW50RS;4VA)	50	96 -	BR8HS	4322	0,7	BR8HVX	6265	212		BR8HIX		7001
BW 50 R (4BX)	50	96 -	BR8HS	4322	0,7	BR8HVX	6265	212		BR8HIX		7001
CR 50 Z (I)	50		BR7HS	4122	0,5	---		211		BR7HIX		7067
CT 50 S (I)	50		BP7HS-10	7829	0,7	---						
CT 50 SS (I)	50		BP7HS	5111	0,7	BP7HVX	7468			BPR7HIX		5944
CW 50 R (4BX)	50		BR8HS	4322	0,7	BR8HVX	6265	212		BR8HIX		7001
Evolis (YE50)(4FW)	50		BR8HS	4322	0,7	BR8HVX	6265	212		BR8HIX		7001
Forte (YA50R) (3UG)	50		BR8HS	4322	0,7	BR8HVX	6265	212		BR8HIX		7001
JogR	50		BR8HS	4322	0,6	BR8HVX	6265	212		BR8HIX		7001
JogRR	50		BR8HS	4322	0,6	BR8HVX	6265	212		BR8HIX		7001
Jog-Z 50 (I)	50	01.95 -	BP7HS	5111	0,7	BP7HVX	7468			BPR7HIX		5944
Neo's	50	97 -	BR8HS	4322	0,6	BR8HVX	6265	212		BR8HIX		7001
Slider (SA09)	50	00 -	BR8HS	4322	0,6	BR8HVX	6265	212		BR8HIX		7001
Spy 50 (I)	50		BR8HS	4322	0,6	BR8HVX	6265	212		BR8HIX		7001
Why (SA03)	50	99 -	BR8HS	4322	0,6	BR8HVX	6265	212		BR8HIX		7001
YA 50 (5AK)	50	97 -	BR7HS	4122	0,7	---		211		BR7HIX		7067
Zest/ YE50 (4FW)	50		BR8HS	4322	0,7	BR8HVX	6265	212		BR8HIX		7001
Evolis (4MU)	80		BR7HS	4122	0,7	---		211		BR7HIX		7067
Zest (4MU)(YE80)	80		BR7HS	4122	0,7	---		211		BR7HIX		7067
Aerox 100	100	01 -	BR8HS	4322	0,6	BR8HVX	6265	212		BR8HIX		7001
BW 100 (SB02)	100	99 - 00	BR8HS	4322	0,6	BR8HVX	6265	212		BR8HIX		7001
BW 100 (SB02)	100	00 -	BR7HS	4122	0,7	---		211		BR7HIX		7067
Neos 100 (SB04)	100	00 -	BR8HS	4322	0,6	BR8HVX	6265	212		BR8HIX		7001
BL 125 (50W)	125	85 - 89	BPR8HS	3725	0,6	---				BPR8HIX		6742
Dodo (SE041)	125	01 -	CR8E	1275	0,7	CR8EVX	6487	226		CR8EIX		4218
Majesty 125 (I)	125		DR8EA	7162	0,6	DR8EVX	6354			DR8EIX		6681
Maxster 125	125	00 -	CR8E	1275	0,7	CR8EVX	6487	226		CR8EIX		4218
Teo's (SE041)	125	01 -	CR8E	1275	0,7	CR8EVX	6487	226		CR8EIX		4218
XC 125 (3TE)	125	90 -	CR6HSA	2983	0,7	---				CR6HIX		7274
XC 125 Beluga	125		CR6HSA	2983	0,7	---				CR6HIX		7274
XC 125 Cygnus	125	- 94	CR6HSA	2983	0,7	---				CR6HIX		7274
XC 125 Cygnus	125	04 -	CR7E	4578	0,7	---		225		CR7EIX		7385
XC 125 Cygnus	125	01.95 -	CR7E	4578	0,7	---		225		CR7EIX		7385
XC 125 T (4KY)	125	95 -	CR7E	4578	0,6	---		225		CR7EIX		7385
XC 125 T (4NB)	125	94 -	CR7E	4578	0,7	---		225		CR7EIX		7385

					Order No.		Platin 	Order No.	Quick-No.	Iridium 	Order No.
AEON											
Cobra	50	03 -	BPR7HS	6422	0,8	BPR7HVX	2938	215	BPR7HIX	5944	
Minicolt	50	03 -	BPR7HS	6422	0,8	BPR7HVX	2938	215	BPR7HIX	5944	
Revo	50	04 -	BPR7HS	6422	0,8	BPR7HVX	2938	215	BPR7HIX	5944	
Cobra	100	02 -	BPR7HS	6422	0,8	BPR7HVX	2938	215	BPR7HIX	5944	
Revo	100	04 -	BPR7HS	6422	0,8	BPR7HVX	2938	215	BPR7HIX	5944	
Cobra Sport	125	02 -	CR8HSA	2086	0,8	CR8HVX	7236		CR8HIX	7669	
Cobra RS 1	125		CR7HS	7223	0,8				CR7HIX	7544	
Cobra RS 2	125		CR7HS	7223	0,8				CR7HIX	7544	
Overland	125	04 -	CR7HS	7223	0,8				CR7HIX	7544	
Utility	125	02 -	CR7HS	7223	0,8				CR7HIX	7544	
Cobra RS 2	180	04 -	CR7HSA	4549	0,8				CR7HIX	7544	
Cobra Sport	180	02 -	CR8HSA	2086	0,8	CR8HVX	7236		CR8HIX	7669	
Cobra RS 1	180		CR7HS	7223	0,8				CR7HIX	7544	
Cobra RS 2	180		CR7HS	7223	0,8				CR7HIX	7544	
Overland	180	04 -	CR7HS	7223	0,8				CR7HIX	7544	
Utility	180	02 -	CR7HS	7223	0,8				CR7HIX	7544	
ARCTIC CAT											
90	90	02 -	BPR7HS	6422	0,6	BPR7HVX	2938	215	BPR7HIX	5944	
250 Quad 4x4	250	01 -	DR7EA	7839	0,6						
300 Quad 2x4 / 4x4	300	99 -	DR7EA	7839	0,6						
300	300	04 -	DR7EA	7839	0,6						
375	375	02 -	CR7E	4578	0,8			225	CR7EIX	7385	
400	400	- 98	CR8E	1275	0,7	CR8EVX	6487	226	CR8EIX	4218	
400	400	99 - 01	CR6E	6965	0,7						
400	400	03 -	CR7E	4578	0,8			225	CR7EIX	7385	
400	400	04 -	CR7E	4578	0,6			225	CR7EIX	7385	
400 TBX	400	04 -	CR7E	4578	0,6			225	CR7EIX	7385	
400i	400	04 -	CR7E	4578	0,6			225	CR7EIX	7385	
454	454	96 - 97	CR8E	1275	0,7	CR8EVX	6487	226	CR8EIX	4218	
454	454	98 -	CR6E	6965	0,7						
500	493	99 -	CR6E	6965	0,7						
500 Auto	493	01 -	CR6E	6965	0,7						
500 TBX	500	04 -	CR6E	6965	0,7						
500 TRV	500	04 -	CR6E	6965	0,7						
ATK											
50 Mini Quad	50	01 -	B7HS	5110	0,5	B7HVX	7836	204	BR7HIX	7067	
90 Mini Quad	90	01 -	B7HS	5110	0,5	B7HVX	7836	204	BR7HIX	7067	
BOMBARDIER											
50 DS	50	02 -	BPR7HS	6422	0,6	BPR7HVX	2938	215	BPR7HIX	5944	
50 Quest	50	03 - 03	BPR7HS	6422	0,6	BPR7HVX	2938	215	BPR7HIX	5944	
DS 50	50	04 -	BR9ECS	3570	0,5						
Quest 50	50	04 -	BR9ECS	3570	0,5						
90 DS	83	02 -	BPR7HS	6422	0,6	BPR7HVX	2938	215	BPR7HIX	5944	
90 DS 4stroke	90	02 -	CR7HSA	4549	0,7				CR7HIX	7544	
90 Quest	90	03 - 03	CR7HSA	4549	0,7				CR7HIX	7544	
DS 90	90	04 -	BR9ECS	3570	0,5						
Quest 90	90	04 -	BR9ECS	3570	0,5						
175	175	03 -	CR8E	1275	0,7	CR8EVX	6487	226	CR8EIX	4218	
Rally 200	176	04 -	BR9ECS	3570	0,5						



Order No.



Gold-Palladium

Platin



Order No.

Quick-No.

Iridium



Order No.

BOMBARDIER

200 Rally	200	03 -	CR8E	1275	0,7	CR8EVX	6487	226	CR8EIX	4218
330	330	02 -	DCPR8E	4339	0,9	DCPR8EVX	2265		DCPR8EIX	6546
Outlander 330	330	04 -	BR9ECS	3570	0,5					
400 Outlander	400	03 -	DCPR8E	4339	0,9	DCPR8EVX	2265		DCPR8EIX	6546
Outlander 400	400	04 -	BR9ECS	3570	0,5					
Quest 498	498	03 -	BR9ECS	3570	0,5					
Traxter 498	498	03 -	BR9ECS	3570	0,5					
500	500	02 -	DCPR8E	4339	0,9	DCPR8EVX	2265		DCPR8EIX	6546
500 Traxter 7401	500	99 - 02	DR8EA	7162	0,7	DR8EVX	6354		DR8EIX	6681
500 Traxter 7414	500	98 - 02	DR8EA	7162	0,7	DR8EVX	6354		DR8EIX	6681
Quest 644	644	03 -	BR9ECS	3570	0,5					
650 Quest	650	02 - 03	DCPR8E	4339	0,9	DCPR8EVX	2265		DCPR8EIX	6546
650 Traxter DS / DR	650	00 -	DR8EA	7162	0,7	DR8EVX	6354		DR8EIX	6681
650 DS 653	653	03 -	BR9ECS	3570	0,5					

CANNONDALE

FX 400	432	00 -	CR9EK	4548	0,7			230	CR9EIX	3521
440 Moto	440	02 -	CR9EK	4548	0,7			230	CR9EIX	3521
Blaze	440	02 -	CR9EK	4548	0,7			230	CR9EIX	3521
Cannibal	440	02 -	CR9EK	4548	0,7			230	CR9EIX	3521
Glamis	440	03 -	CR9EK	4548	0,7			230	CR9EIX	3521
Speed	440	02 -	CR9EK	4548	0,7			230	CR9EIX	3521

CPI

200	50	03 -	BR7ES	5122	0,8	BR7EVX	4556			
Carb 50	50	03 -	BR8HSA	5539	0,8	BR8HVX	6265		BR8HIX	7001
Carb 100	100	03 -	BR8HSA	5539	0,8	BR8HVX	6265		BR8HIX	7001

DAREN

50	50	00 -	BPR7HS	6422	0,8	BPR7HVX	2938	215	BPR7HIX	5944
100	100	00 -	BPR7HS	6422	0,8	BPR7HVX	2938	215	BPR7HIX	5944
125	125	00 -	DR8EA	7162	0,7	DR8EVX	6354		DR8EIX	6681
150	150	00 -	DR8EA	7162	0,7	DR8EVX	6354		DR8EIX	6681

DERBI

170	170		DR8EA	7162	0,7	DR8EVX	6354		DR8EIX	6681
250	250		CR8HS	7423	0,7	CR8HVX	7236		CR8HIX	7669

DRR







DRR 50	50	04 -	BP7HS	5111	0,7	BP7HVX	7468		BPR7HIX	5944
DRR 90	90	04 -	BP7HS	5111	0,7	BP7HVX	7468		BPR7HIX	5944
DRR 90 GT	90	04 -	C7HSA	4629	0,7	C7HVX	4533		CR7HIX	7544

ERING

Tornado 50 ATV	50		BP7HS	5111	0,5	BP7HVX	7468		BPR7HIX	5944
----------------	----	--	-------	------	-----	--------	------	--	---------	------

E-TON

Viper Juior	40	03 -	BPM7A	7321	0,6			305		
Viper	50	02 -	BPR7HS	6422	0,8	BPR7HVX	2938	215	BPR7HIX	5944
Sierra Ranger	90	03 -	BPR7HS	6422	0,8	BPR7HVX	2938	215	BPR7HIX	5944
Viper	90	02 -	BPR7HS	6422	0,8	BPR7HVX	2938	215	BPR7HIX	5944
Yukon	150	99 -	C7HSA	4629	0,7	C7HVX	4533		CR7HIX	7544

					Order No.		Platin 	Order No.	Quick-No.	Iridium 	Order No.
FOX											
50	50	00 -	BPR7HS	6422	0,8	BPR7HVX	2938	215	BPR7HIX		5944
50 VR Sport	50	01 -	BPR7HS	6422	0,8	BPR7HVX	2938	215	BPR7HIX		5944
90 MT	90	99 -	CR7HSA	4549	0,8				CR7HIX		7544
100	100	00 -	BPR7HS	6422	0,8	BPR7HVX	2938	215	BPR7HIX		5944
G + G											
QUAD	not Twinspark	1130	03 -	BKR7EKC	7354						
GAS GAS											
300 Wild	300	02 -	BR8EG	3130	0,5						
450 Wild	450	02 -	CR8E	1275	0,7	CR8EVX	6487	226	CR8EIX		4218
HONDA											
TRX 70	70		CR7HS	7223	0,7				CR7HIX		7544
TRX 90	90	93 - 94	CR6HSA	2983	0,7				CR6HIX		7274
TRX 90	90	95 -	CR7HSA	4549	0,7				CR7HIX		7544
ATC 125 M	125		DR8ESL	2923	0,6	DR8EVX	6354	218	DR8EIX		6681
TRAX 125	125		DR8ESL	2923	0,7	DR8EVX	6354	218	DR8EIX		6681
TRX 125	125		DR8ESL	2923	0,7	DR8EVX	6354	218	DR8EIX		6681
ATC 185	185		D8EA	2120	0,7	D8EVX	2850	216	DR8EIX		6681
ATC 185 S	185		DR8ESL	2923	0,6	DR8EVX	6354	218	DR8EIX		6681
ATC 200	200		DR8ESL	2923	0,6	DR8EVX	6354	218	DR8EIX		6681
TRX 200 D	200	92 -	DR8ESL	2923	0,6	DR8EVX	6354	218	DR8EIX		6681
TRX 200 SX	200		DR8ESL	2923	0,7	DR8EVX	6354	218	DR8EIX		6681
ATC 250 ES /SX	250	85 -	DR8ESL	2923	0,7	DR8EVX	6354	218	DR8EIX		6681
ATC 250 R	250		BR9ES	5722	0,8	BR9EVX	1265	208	BR9EIX		3981
FL 250	250		BR9ES	5722	0,8	BR9EVX	1265	208	BR9EIX		3981
TRAX 250	250		DR8ESL	2923	0,6	DR8EVX	6354	218	DR8EIX		6681
TRX 250	250		DR8ESL	2923	0,6	DR8EVX	6354	218	DR8EIX		6681
TRX 250 EX	250	05 -	DPR8EA-9	4929	0,9	DPR8EVX-9	2872	221	DPR8EIX-9		2202
TRX 250 R	250		BR9ES	5722	0,6	BR9EVX	1265	208	BR9EIX		3981
TRX 250 X	250		DR8ESL	2923	0,7	DR8EVX	6354	218	DR8EIX		6681
TRX 300	300	93 -	DPR8EA-9	4929	0,9	DPR8EVX-9	2872	221	DPR8EIX-9		2202
TRX 300 EX	300	93 -	DR8ESL	2923	0,6	DR8EVX	6354	218	DR8EIX		6681
TRX 300 FW	300	93 -	DPR8EA-9	4929	0,9	DPR8EVX-9	2872	221	DPR8EIX-9		2202
TRX 300 N	300	92 -	DPR8EA-9	4929	0,9	DPR8EVX-9	2872	221	DPR8EIX-9		2202
TRX 300 EX	300	05 -	DR8ES-L	2923	0,7	DR8EVX	6354		DR8EIX		6681
ATC 350 X	350		DR8ESL	2923	0,7	DR8EVX	6354	218	DR8EIX		6681
FL 350 R	350		BR9ES	5722	0,8	BR9EVX	1265	208	BR9EIX		3981
TRX 350 FE	350	05 -	DPR7EA-9	5129	0,9	DPR7EVX-9	7682	220	DPR7EIX-9		7803
TRX 350	350	93 -	DR8ESL	2923	0,6	DR8EVX	6354	218	DR8EIX		6681
TRX 350 FM	350	05 -	DPR7EA-9	5129	0,9	DPR7EVX-9	7682	220	DPR7EIX-9		7803
TRX 350 TE	350	05 -	DPR7EA-9	5129	0,9	DPR7EVX-9	7682	220	DPR7EIX-9		7803
TRX 350 TM	350	05 -	DPR7EA-9	5129	0,9	DPR7EVX-9	7682	220	DPR7EIX-9		7803
TRX 400 FA	400	05 -	DPR8EA-9	4929	0,9	DPR8EVX-9	2872	221	DPR8EIX-9		2202
TRX 400 FGA	400	05 -	DPR8EA-9	4929	0,9	DPR8EVX-9	2872	221	DPR8EIX-9		2202
TRX 400 FW	400	95 -	DPR7EA-9	5129	0,9	DPR7EVX-9	7682	220	DPR7EIX-9		7803
TRX 450	450	05 -	DPR7EA-9	5129	0,9	DPR7EVX-9	7682	220	DPR7EIX-9		7803
TRX 500	500	05 -			0,9				IJR7A-9		
TRX 500 FA	500	02 -							IJR7A-9		
Rincon TRX 650	650	01.04 -			1,1				IFR5L-11		
TRX 650 FA	650	05 -			1,1				IFR5L-11		



Order No.



Gold-Palladium

Platin



Order No.

Quick-No.

Iridium



Order No.

HONDA
TRX 650 FGA

650 05 - 1,1 IFR5L-11

HYOSUNG

50	50	03 -	BP6HS	4511	0,7	BP6HVX	4635		BPR6HIX	4085
90	50	03 -	BPR7HS	6422	0,8	BPR7HVX	2938	215	BPR7HIX	5944
WOW 50	50	04 -	BP7HS	5111	0,7	BP7HVX	7468		BPR7HIX	5944
WOW 90	90	04 -	BP7HS	5111	0,7	BP7HVX	7468		BPR7HIX	5944

JOHN DEERE

Gator 6x4			BMR2A-10	4452	1,0					
Gator 4x2			BPR6ES	7822	0,8	BPR6EVX	6764		BPR6EIX	6637

KARCHER

KM 170-8	170		DR8EA	7162	0,7	DR8EVX	6354		DR8EIX	6681
KM 250-10	250		CR8HS	7423	0,7	CR8HVX	7236		CR8HIX	7669
KM 250-11	250		CR8HS	7423	0,7	CR8HVX	7236		CR8HIX	7669
KM 250-9	250		CR8HS	7423	0,7	CR8HVX	7236		CR8HIX	7669

KAWASAKI







KFX 50 A (SQ)	50	03 -	BPR4HS	7823	0,7					
KFX 80	80	04 -	BPR4HS	7823	0,6					
KLF 185	185		DR8ES	5423	0,7	DR8EVX	6354	217	DR8EIX	6681
KLF 220	220	88 - 02	DR8ES	5423	0,7	DR8EVX	6354	217	DR8EIX	6681
KDX 250	250		BR8ES	5422	0,8	BR8EVX	1262	207	BR8EIX	5044
KDX 250	250	91 -	BR9ES	5722	0,8	BR9EVX	1265	208	BR9EIX	3981
KDX 250 SR	250	92 -	BR8ES	5422	0,8	BR8EVX	1262	207	BR8EIX	5044
KLF 250 A	250	02 -	DR8ES	5423	0,7	DR8EVX	6354	217	DR8EIX	6681
KEF 300 A&B (SQ)	300	95 -	DR7EA	7839	0,7					
KLF 300	300	88 -	BR8ES	5422	0,8	BR8EVX	1262	207	BR8EIX	5044
KVF 360 A & B	360	02 -	DPR8EA-9	4929	0,9	DPR8EVX-9	2872	221	DPR8EIX-9	2202
KFX 400 A (SQ)	400	03 -	CR8E	1275	0,7	CR8EVX	6487	226	CR8EIX	4218
KFX 400	400	03 -	CR7E	4578	0,8				225	CR7EIX
KLF 400 B	400	93 - 99	DPR8EA-9	4929	0,9	DPR8EVX-9	2872	221	DPR8EIX-9	2202
KVF 400 C&D	400	99 - 02	DPR8EA-9	4929	0,9	DPR8EVX-9	2872	221	DPR8EIX-9	2202
KVF 650 4X4	650	05 -	CR7E	4578	0,8				225	CR7EIX
KVF 650 A	650	00 -	CR7E	4578	0,8				225	CR7EIX
KFV 700	700	04 -	CR7E	4578	0,8				225	CR7EIX
KFX 700	700	04 -	CR7E	4578	0,8				225	CR7EIX
KSV 700	700	04 -	CR7E	4578	0,8				225	CR7EIX
KVF 750	750	05 -	CR7E	4578	0,8				225	CR7EIX

KYMCO

MX 50	50	01 -	BR8HSA	5539	0,5	BR8HVX	6265		BR8HIX	7001
MX 150	150	01 -	DR8EA	7162	0,7	DR8EVX	6354		DR8EIX	6681
KXR 250	250	01 -	DPR7EA-9	5129	0,9	DPR7EVX-9	7682	220	DPR7EIX-9	7803
MXU 250	250	05 -	DPR7EA-9	5129	0,9	DPR7EVX-9	7682	220	DPR7EIX-9	7803

MOTOR TEK

Raccoon 50	50	05 -								
MT 125	125	05 -	CR7HSA	4549	0,8				CR7HIX	7544
MT 175	175	05 -	DR8EA	7162	0,7	DR8EVX	6354		DR8EIX	6681

					Order No.		Platin 	Order No.	Quick-No.	Iridium 	Order No.
MZ											
ATV 50	50	03 -	BP6HS	4511	0,6	BP6HVX	4635			BPR6HIX	4085
ATV 100	100	03 -	BP6HS	4511	0,6	BP6HVX	4635			BPR6HIX	4085
PANDA											
KD 50 A	50	00 -	CR6HSA	2983	0,7					CR6HIX	7274
KD 80 A	80	00 -	CR6HSA	2983	0,7					CR6HIX	7274
KD 125 A	125	00 -	CR6HSA	2983	0,7					CR6HIX	7274
POLARIS											
Big Boss	244	89 - 93	BR8ES	5422	0,6	BR8EVX	1262	207		BR8EIX	5044
Cyclone	244	88 - 89	BR8ES	5422	0,6	BR8EVX	1262	207		BR8EIX	5044
Scrambler	244	89 - 93	BR8ES	5422	0,6	BR8EVX	1262	207		BR8EIX	5044
Trail Blazer	244	90 -	BR8ES	5422	0,6	BR8EVX	1262	207		BR8EIX	5044
Trail Boss	244	85 -	BR8ES	5422	0,6	BR8EVX	1262	207		BR8EIX	5044
Xplorer 300	283	94 -	BR8ES	5422	0,6	BR8EVX	1262	207		BR8EIX	5044
Xpress 300	283	94 -	BR8ES	5422	0,6	BR8EVX	1262	207		BR8EIX	5044
Sportsman 335	334	99 -	BKR7E	6097	0,6					BKR7EIX	2667
Big Boss	350	93 -	BR8ES	5422	0,6	BR8EVX	1262	207		BR8EIX	5044
Trail Boss	350	90 - 93	BR8ES	5422	0,6	BR8EVX	1262	207		BR8EIX	5044
Big Boss 400L (6X6)	379	95 - 97	BR8ES	5422	0,6	BR8EVX	1262	207		BR8EIX	5044
Scambler 400 (4X4)	379	94 -	BR8ES	5422	0,6	BR8EVX	1262	207		BR8EIX	5044
Sport 400	379	98 -	BR8ES	5422	0,6	BR8EVX	1262	207		BR8EIX	5044
Sport ATV	379	95 - 97	BR8ES	5422	0,6	BR8EVX	1262	207		BR8EIX	5044
Sportsman 4x4	379	94 - 97	BR8ES	5422	0,6	BR8EVX	1262	207		BR8EIX	5044
Xplorer 400/400L 4x4	379	94 -	BR8ES	5422	0,6	BR8EVX	1262	207		BR8EIX	5044
Xpress 400 L 2x4	379	96 - 97	BR8ES	5422	0,6	BR8EVX	1262	207		BR8EIX	5044
Magnum (2X4)	425	95 -	BKR5E	7938	0,6					BKR5EIX	6341
Magnum (4X4)	425	95 -	BKR5E	7938	0,6					BKR5EIX	6341
Magnum (6X6)	425	96 - 97	BKR5E	7938	0,6					BKR5EIX	6341
Big Boss 500 (6X6)	500	98 -	BKR5E	7938	0,6					BKR5EIX	6341
Magnum 500	500	99 -	BKR5E	7938	0,6					BKR5EIX	6341
Ranger	500	99 -	BKR5E	7938	0,6					BKR5EIX	6341
Scrambler 500	500	98 -	BKR5E	7938	0,6					BKR5EIX	6341
Sportsman 500	500	96 -	BKR5E	7938	0,6					BKR5EIX	6341
Xplorer 500	500	97 -	BKR5E	7938	0,6					BKR5EIX	6341
Sportsmann 600	600	03 -	BKR7E	6097	0,6					BKR7EIX	2667
Sportsmann 700	700	03 -	BKR7E	6097	0,6					BKR7EIX	2667
SUZUKI											
LT 50	50		BPR4HS	7823	0,7						
LT 80	80		BPR7HS	6422	0,7	BPR7HVX	2938	215		BPR7HIX	5944
LT 160 E	160	- 92	D7EA	7912	0,7	D7EVX	2734				
LT 160 E	160	93 -	DPR7EA-9	5129	0,9	DPR7EVX-9	7682	220		DPR7EIX-9	7803
LT 160 F	160	93 -	DP7EA-9	5629	0,9	DPR7EVX-9	7682			DPR7EIX-9	7803
LT-F 160	160	95 -	DP7EA-9	5629	0,9	DPR7EVX-9	7682			DPR7EIX-9	7803
LT 230 E	230	93 -	D7EA	7912	0,7	D7EVX	2734				
LT 230 E/F	230		DR7ES	3123	0,7						
LT 230 GE	230		D7EA	7912	0,7	D7EVX	2734				
LT 250 4WD/F4WD	250	- 94	DR7ES	3123	0,7						
LT 250 E/EF	250	93 -	D8EA	2120	0,7	D8EVX	2850	216		DR8EIX	6681
LT 250 EF	250		DR8ESL	2923	0,7	DR8EVX	6354	218		DR8EIX	6681
LT 250 R	250				0,6	BR8EVX	1262			BR8EIX	5044



Order No.



Gold-Palladium

Platin



Order No.

Quick-No.

Iridium



Order No.

SUZUKI

LT 250 R	250	93 -			0,6	B9EGV	5827			
LT 250 S	250		DPR7EA-9	5129	0,9	DPR7EVX-9	7682	220	DPR7EIX-9	7803
LTF 250	250	93 -	DR7ES	3123	0,7					
LTF 250	250	- 94	DR7ES	3123	0,7					
LTF 250	250	95 -	D7EA	7912	0,6	D7EVX	2734			
LT-4 WDX	280	95 -	D7EA	7912	0,6	D7EVX	2734			
LT-4WD / F4WD	280	95 -	DR7EA	7839	0,6					
LT-F4WDX	280	93 - 94	DR7ES	3123	0,7					
LT-300	300	87 - 89	D8EA	2120	0,6	D8EVX	2850	216	DR8EIX	6681
LT-F 300	300	99 -	D7EA	7912	0,6	D7EVX	2734			
LT-A 400	400	02 -	CR7E	4578	0,6				225 CR7EIX	7385
LT-A 400F	400	02 -	CR7E	4578	0,6				225 CR7EIX	7385
LT-F 400F	400	02 -	CR7E	4578	0,6				225 CR7EIX	7385
LT-F 400	400	02 -	CR7E	4578	0,6				225 CR7EIX	7385
LT-Z 400	400	02 -	CR7E	4578	0,6				225 CR7EIX	7385
LT-A 500F	500	00 -	CR6E	6965	0,6					
LT-F 500	500	98 - 99	CR7E	4578	0,6				225 CR7EIX	7385
LT-F 500F	500	00 -	CR6E	6965	0,6					

TRAILBLAZER

170	170	04 -	DR8EA	7162	0,7	DR8EVX	6354		DR8EIX	6681
-----	-----	------	-------	------	-----	--------	------	--	--------	------

TRAILSPORT

TS-500 5.0hp		04 -	BR2LM	5798	0,6			310		
TSB-600 6.0hp		04 -	BR2LM	5798	0,6			310		

UNISOM







Desert-Cat 50	50	04 -	BR8HS	4322	0,6	BR8HVX	6265	212	BR8HIX	7001
Desert-Cat 90	90	04 -	BR8HS	4322	0,6	BR8HVX	6265	212	BR8HIX	7001

XING FU

XF Trail 150	150	05 -	C7HSA	4629	0,6	C7HVX	4533		CR7HIX	7544
XF Trail 250	250	05 -	C7HSA	4629	0,6	C7HVX	4533		CR7HIX	7544

YAMAHA

YMF 50 S	50	04 -	CR7HS	7223	0,7				CR7HIX	7544
YF 60 (1HN)	60	87 - 88	BPR6HS	7022	0,7	BPR6HVX	2740	214	BPR6HIX	4085
YFM 80	80		CR7HS	7223	0,7				CR7HIX	7544
YFM 80 W Raptor	80	02 -	CR7HS	7223	0,7				CR7HIX	7544
YFM 80 W Badger	80	02 -	CR7HS	7223	0,7				CR7HIX	7544
YFM 80 E / F	80	93 -	C7HSA	4629	0,7	C7HVX	4533		CR7HIX	7544
YFA 1 Breeze	125	89 - 04	CR7HS	7223	0,7				CR7HIX	7544
YFA 1 F	125	94 -	C7HSA	4629	0,7	C7HVX	4533		CR7HIX	7544
YT 125	125		BP6ES	7811	0,8	BP6EVX	5832		BPR6EIX	6637
YT 125 CH	125		BP6ES	7811	0,8	BP6EVX	5832		BPR6EIX	6637
YT 125 H	125		BP6ES	7811	0,8	BP6EVX	5832		BPR6EIX	6637
YT 175	175		BP7ES	2412	0,8	BP7EVX	7270	206	BPR7EIX	4055
YFM 200	200	92 -	D7EA	7912	0,6	D7EVX	2734			
YFM 200 (52H)	200	85 - 86	DR7ES	3123	0,7					
YFM 225 (2HT)	200		DR7ES	3123	0,7					
YFM 225 (59V)	200		DR7ES	3123	0,7					
YFS 200 Blaster	200	90 - 04	BR8ES	5422	0,8	BR8EVX	1262	207	BR8EIX	5044

					Order No.		Gold-Palladium	Platin 	Order No.	Quick-No.	Iridium 	Order No.
YAMAHA												
YFS 200 E / F	200	93 -	B8ES	2411	0,8	B8EVX	7051	201	BR8EIX	5044		
YFM 225 59V/2HT	225	92 -	DR7ES	3123	0,7							
TT 225	225		DR8ESL	2923	0,7	DR8EVX	6354	218	DR8EIX	6681		
YFB 250 / E / F / FWF	250	93 -	D7EA	7912	0,7	D7EVX	2734					
YFB 250 / FW	250	94 -	DR7EA	7839	0,7							
YFM 250 Timberwolf	250		DR7EA	7839	0,7							
YFM 250 (3GH)	250	90 -	DR7ES	3123	0,7							
YFM 250 Bruin	250	05 -	DR7EA	7839	0,6							
YFM 250 X Bear Tracker	250	99 - 04	DR7EA	7839	0,7							
YFM 350 (3HN)	350	89 -	DR8ESL	2923	0,6	DR8EVX	6354	218	DR8EIX	6681		
YFM 350 2HR/2HN	350	92 -	DR8ESL	2923	0,6	DR8EVX	6354	218	DR8EIX	6681		
YFM 350 4x4 (3HN)	350		DR8ESL	2923	0,7	DR8EVX	6354	218	DR8EIX	6681		
YFM 350 4x4 (2HR)	350		DR8ESL	2923	0,7	DR8EVX	6354	218	DR8EIX	6681		
YFM 350 ERF / FWF / XF	350	94 -	D8EA	2120	0,7	D8EVX	2850	216	DR8EIX	6681		
YFM 350 FW	350	94 -	DR8EA	7162	0,7	DR8EVX	6354		DR8EIX	6681		
YFM 350 X Warrior	350	97 - 04	DR8EA	7162	0,7	DR8EVX	6354		DR8EIX	6681		
YFZ 350	350	94 -	BR8ES	5422	0,8	BR8EVX	1262	207	BR8EIX	5044		
YFZ 350 Banshee	350	86 - 04	BR8ES	5422	0,8	BR8EVX	1262	207	BR8EIX	5044		
YFZ 350 E / F	350	93 -	B8ES	2411	0,8	B8EVX	7051	201	BR8EIX	5044		
YFM 400	400	93 -	DR8ESL	2923	0,7	DR8EVX	6354	218	DR8EIX	6681		
YFM 400 AN Kodiak	400	03 - 04	DR8EA	7162	0,7	DR8EVX	6354		DR8EIX	6681		
YFM 400 FW	400	94 - 04	DR8EA	7162	0,7	DR8EVX	6354		DR8EIX	6681		
YFM 400 FWF	400	94 -	D8EA	2120	0,7	D8EVX	2850	216	DR8EIX	6681		
YFM 400 FWA Kodiak	400	00 - 04	DR8EA	7162	0,7	DR8EVX	6354		DR8EIX	6681		
YFM 450 FWAN Kodiak	400	03 - 04	DR8EA	7162	0,7	DR8EVX	6354		DR8EIX	6681		
YFZ 450 S	450	04 -	CR8E	1275	0,7	CR8EVX	6487	226	CR8EIX	4218		
YFM 660 FWA Grizzly	660	02 - 04	DPR8EA-9	4929	0,9	DPR8EVX-9	2872	221	DPR8EIX-9	2202		
YFM 660 R Raptor	660	01 - 04	DPR8EA-9	4929	0,9	DPR8EVX-9	2872	221	DPR8EIX-9	2202		
YXR 660 Rhino	660	05 -	DPR8EA-9	4929	0,9	DPR8EVX-9	2872	221	DPR8EIX-9	2202		
YXR 660 FAS	660	04 -	DPR8EA-9	4929	0,9	DPR8EVX-9	2872	221	DPR8EIX-9	2202		
YERF-DOG												
23000	90	04 -	BP7HS	5111	0,7	BP7HVX	7468		BPR7HIX	5944		
23100	150	04 -	BR6ES	4922	0,6							

Order-
No.**APRILIA**

AF1 50		01.86 -	50	LB05F	8051
ET 50 AE,-Fire		01.87 -	50	LB05F	8051
GL 50		02.93 -	50	LB05F	8051
LX 50		02.93 -	50	LB05F	8051
RC 50		01.79 - 12.82	50	LB05F	8051
Red Rose 50		06.87 -	50	LB05F	8051
RS 50 Extrema/Replica		01.93 -	50	LB05F	8051
RX 125		01.90 -	125	LB05F	8051
RX 50		09.90 -	50	LB05F	8051
Tuareg 50		01.87 -	50	LB05F	8051

BMW

R 45	20kW	06.78 - 07.85	475	LB05F	8051
R 45	26kW	06.78 - 06.83	475	LB05F	8051
R 50/5			500	LB05F	8051
R 60/5, /6, /7		- 06.78	600	LB05F	8051
R 65		06.78 -	650	LB05F	8051
R 75/5, /6, /7			750	LB05F	8051
R 80		08.82 - 95	800	LB05F	8051
R 80 RT		08.82 - 95	800	LB05F	8051
R 80 ST		08.82 - 95	800	LB05F	8051
R 80 R		80 -	800	LB05F	8051
R 80 GS		08.82 - 94	800	LB05F	8051
R 80/7N /7S		09.77 - 08.80	800	LB05F	8051
R 90/6			900	LB05F	8051
R 90/S			900	LB05F	8051
R 100			1000	LB05F	8051
R 100 R		94 -	1000	LB05F	8051
R 100 RS		09.86 -	1000	LB05F	8051
R 100/7			1000	LB05F	8051
R 100/CS /RT			1000	LB05F	8051
R 100/RS		- 08.86	1000	LB05F	8051
R 100 GS		09.86 -	1000	LB05F	8051
R 100/S /T		09.76 - 08.80	1000	LB05F	8051
R 1100 GS	59kW	08.93 - 99	1100	LB05F	8051
R 850 GS		98 -	850	LB05F	8051
R 850 R	52kW	10.94 -	850	LB05F	8051
R 850 RT		99 -	850	LB05F	8051

CAGIVA

Ala Blu 350			350	LB05F	8051
Ala Rossa 350/4T		01.83 -	350	LB05F	8051
Ala Verde 350			350	LB05F	8051
Alazzurra 350 (D)		01.84 -	350	LB05F	8051
All			175	LB05F	8051
All			200	LB05F	8051
Elefant 350 (D)			350	LB05F	8051
Lucky 350			350	LB05F	8051
MX,MXR,RR,RX,WMX			250	LB05F	8051

Order-
No.

				CAGIVA
NC,RL,SS,SST	01.83 -	250	LB05F	8051
RX 250 Rally	01.79 - 11.83	250	LB05F	8051
SST 350		350	LB05F	8051
SX, SXT	01.83 - 12.84	250	LB05F	8051
W12	94 -	350	SD05FP	8325
WMX 125/84		125	LB05F	8051
WMX 125/85		125	LB05F	8051
WMX 125/88		125	LB05F	8051
				DAELIM
125 Daystar	01.00 -	125	XB01F	8431
VC 125 Advance	95 -	125	XB01F	8431
VT 125 Evolution	03.98 -	125	XB01F	8431
				DUCATI
600 Pantah SL/TL (D)	81 -	600	VB05F	8032
900 S,SS,GTS,SD,S2,HR (D)	80 -	900	VB05F	8032
				GAS GAS
Cross 250		250	LB05F/CR2	8051/8048
TT 125		125	LB05F/CR2	8051/8048
TT 200		200	LB05F/CR2	8051/8048
TT 250		250	LB05F/CR2	8051/8048
TT 300		300	LB05F/CR2	8051/8048
				GILERA
125 5V Regolarità		125	LB05F	8051
125 Arcore, Export	01.72 - 06.80	125	LB05F	8051
125 SV Regolarità		125	LB05F	8051
50 TS	01.79 - 12.82	50	LB05F	8051
CB1 4V		50	LB05F	8051
Giubileo 4 T, SS		98	LB05F	8051
Saturno 500	04.88 - 92	500	LB05F	8051
Touring	01.73 - 12.81	50	LB05F	8051
Trial		50	LB05F	8051
				HERCULES
175 GS		175	LB05F	8051
250 GS		250	LB05F	8051
350 GS		350	LB05F	8051
City Bike C1	10.72 - 08.78	50	LB05F	8051
City Bike C2	10.72 - 08.78	50	LB05F	8051
City Bike C3	09.74 - 08.78	50	LB05F	8051
Hobby Rider HR 1	10.72 - 12.87	50	LB05F	8051
Hobby Rider HR 2	10.72 - 12.87	50	LB05F	8051
Jogging		50	LB05F	8051
K 100 X		100	LB05F	8051
K 125 BW Military	09.74 -	125	LB05F	8051
K 125 GS		125	LB05F	8051
K 125 MC		125	LB05F	8051
K 125 S	10.72 - 08.79	125	LB05F	8051
K 125 T	10.72 - 08.79	125	LB05F	8051

Order-
No.**HERCULES**

K 125 X		125	LB05F	8051
K 50	- 08.78	50	LB05F	8051
K 50 Ultra	- 08.78	50	LB05F	8051
K 50 Ultra II	- 08.78	50	LB05F	8051
K 50 Ultra LC	- 08.78	50	LB05F	8051
K 50 Ultra LC II	- 08.78	50	LB05F	8051
K 50 Ultra LC III	- 08.78	50	LB05F	8051
KX 5	01.86 -	50	LB05F	8051
Lastboy		50	LB05F	8051
M1	10.72 - 12.77	50	LB05F	8051
M2	10.72 - 12.77	50	LB05F	8051
M4	09.74 - 12.78	50	LB05F	8051
M5	09.74 - 12.78	50	LB05F	8051
MK 1S	01.78 - 08.80	50	LB05F	8051
MK 2S	01.78 - 08.80	50	LB05F	8051
MP 2	10.72 - 12.77	50	LB05F	8051
MP 4	10.72 - 12.77	50	LB05F	8051
MX 1		50	LB05F	8051
MX 1	01.89 -	50	LB05F	8051
Optima 3	01.78 -	50	LB05F	8051
Optima 50		50	LB05F	8051
Prima 2		50	LB05F	8051
Prima 2S	01.89 -	50	LB05F	8051
Prima 3		50	LB05F	8051
Prima 3S	01.89 -	50	LB05F	8051
Prima 4		50	LB05F	8051
Prima 4LN,5LN		50	LB05F	8051
Prima 5		50	LB05F	8051
Prima 5,5S,5SE	01.89 -	50	LB05F	8051
Prima 6		50	LB05F	8051
Prima G3		50	LB05F	8051
Prima GT	01.89 -	50	LB05F	8051
Prima GT,GX		50	LB05F	8051
Prima Presto		50	LB05F	8051
Prima Pronto		50	LB05F	8051
Prima S		50	LB05F	8051
Prima SL		50	LB05F	8051
Prima SX		50	LB05F	8051
RX 9		80	LB05F	8051
Sport Bike SB1	10.72 - 08.74	50	LB05F	8051
Sport Bike SB2	10.72 - 08.79	50	LB05F	8051
Sport Bike SB3	09.74 - 08.79	50	LB05F	8051
Sport Bike SB5	09.74 - 08.76	50	LB05F	8051
Supra 2D,3D	06.80 -	50	LB05F	8051
Supra 4	06.78 -	50	LB05F	8051
Supra 4GP	01.80 -	50	LB05F	8051
Supra Enduro	03.80 -	50	LB05F	8051
Ultra 50		50	LB05F	8051
Ultra 80 LC		80	LB05F	8051
Ultra 80 AC	01.82 -	80	LB05F	8051
XE 5	01.86 -	50	LB05F	8051
XE 9	01.82 -	80	LB05F	8051

Order-
No.

				HERCULES	
ZX 1		50	LB05F		8051
				HONDA	
250 Spacy (I)		250	LD05F/CR2		8060/8048
ATC 125 M (ATV)		125	LD05F		8060
ATC 185 (ATV)		185	LD05F		8060
ATC 185 S (ATV)		185	LD05F		8060
ATC 200 (ATV)		200	VD05F		8052
ATC 250 ES /SX (ATV)	85 -	250	VD05F		8052
CA 125 C Rebel (JC26)	97 -	125	LD05F		8060
CA 125 Rebel (JC24)	95 -	125	LD05F		8060
Camino PA 50	01.75 - 12.87	50	LB05F		8051
CB 250 (MC26)	96 -	250	XD05F		8072
CB 1000 F (SC30)	93 - 00	1000	SD05F(IN)XD05F(OUT)		8022/8072
CB 1100 F (SC11)		1100	XD05F		8072
CB 1100 R (SC08)		1100	SD05F(IN)XD05F(OUT)		8022/8072
CB 125		125	LD05F		8060
CB 125 K		125	LD05F		8060
CB 125 T		125	LD05F		8060
CB 125 Y		125	LD05F		8060
CB 250 N	01.80 -	250	XD05F		8072
CB 250 RS (MC02)	01.80 -	250	XD05F		8072
CB 250 T		250	LD05F		8060
CB 400 A	01.79 -	400	VD05F(IN)XD05F(OUT)		8052/8072
CB 400 N	01.78 - 12.84	400	XD05F		8072
CB 400 T		400	YB05F		8082
CB 450 N (PC14)	85 -	450	LB05F		8051
CB 450 S (PC17)(D)	86 - 88	450	XD05F		8072
CB 450 S (PC17)(I)		450	XD05F		8072
CB 50		50	LD05F		8060
CB 50 Y	01.73 - 01.83	50	LD05F		8060
CB 550	06.71 - 12.87	550	SD05F(IN)XD05F(OUT)		8022/8072
CB 550 (F1/F2)	76 -	550	SD05F(IN)XD05F(OUT)		8022/8072
CB 550 (K3/4)	76 -	550	SD05F(IN)XD05F(OUT)		8022/8072
CB 550 F	06.71 - 12.87	550	SD05FMC		30465
CB 650 C (RC05)		650	XD05F		8072
CB 650 SC (RC08)	01.80 -	650	XD05F		8072
CB 650 Z		650	XD05F		8072
CB 750 (RC42)	92 -	750	SD05F		8022
CB 750 (RC04)	01.82 - 12.83	750	SD05F		8022
CB 750 C (RC06)	01.80 -	750	SD05F		8022
CB 750 F	- 91	750	SD05F		8022
CB 750 F2		750	SD05F		8022
CB 750 F2N / Fill	91 -	750	SD05F(IN)XD05F(OUT)		8022/8072
CB 750 FA (I)		750	SD05F		8022
CB 750 Four (I)		750	SD05F		8022
CB 750 FZ		750	SD05F		8022
CB 750 K	01.82 - 12.83	750	SD05F		8022
CB 750 KZ		750	SD05F		8022
CB 900 F	01.79 - 12.	900	SD05F(IN)XD05F(OUT)		8022/8072
CB 900 F2	01.79 - 12.83	900	SD05F(IN)XD05F(OUT)		8022/8072
CB-1 (NC27)	91 -	400	SD05F/CR1		8022/8035

Order-
No.

HONDA						
CBR 1000 F	(SC24)	95 - 00	1000	SD05F(IN)XD05F(OUT)	8022/8072	
CBR 1000 F	(SC21)	87 - 88	1000	SD05F(IN)XD05F(OUT)	8022/8072	
CBR 1000 F	(SC24)	89 - 92	1000	SD05F(IN)XD05F(OUT)	8022/8072	
CBR 600 F	(PC19)	87 - 88	600	CR1	8035	
CBR 600 F	(PC23)	89 - 90	600	CR1	8035	
CBR 600 F	(PC25)	91 - 94	600	CR1	8035	
CBR 600 F2		93 - 94	600	CR1	8035	
CBR 600 F3	(PC31)(PC35)	95 - 00	600	CR1	8035	
CBR 900 RR	(SC33)	96 -	900	XD05F	8072	
CBR 900 RR	(SC28)	91 -	900	XD05F	8072	
CBX 1000	(CB1)		1050	XD05F	8072	
CBX 250			250	SD05FM	8392	
CBX 400 F			400	SD05FMC	30465	
CBX 400 F2			400	SD05FMC	30465	
CBX 550 F	(PC04)		550	SD05FMC	30465	
CBX 550 F2	(PC04)		550	SD05FMC	30465	
CBX 600 E		01.83 - 12.87	600	SD05FMC	30465	
CBX 650 E	(RC13)	83 -	650	SD05FMC	30465	
CD 185 T			185	LD05F	8060	
CD 200 T			200	LD05F	8060	
CD 250 U			250	XD05F	8072	
CG 110			110	LD05F	8060	
CG 125	(JC27)	98 -	125	LD05FP	8070	
CG 125			125	LD05F	8060	
CH 125			125	LD05F	8060	
CH 250			250	VD05F	8052	
CLR 125 Cityfly	(JD18A/B)	98 -	125	VD05FMH	8425	
CM 125	(JC05)		125	LD05FP	8070	
CM 125 C Custum		94 -	125	LD05F	8060	
CM 185 T		01.78 -	185	LD05F	8060	
CM 200 T			200	LD05F	8060	
CM 250 C	(MC06)	01.82 -	250	LD05FP	8070	
CM 400 T		01.80 - 12.84	400	XD05F	8072	
CMX 250 C	(MC32B)	97 -	250	VD05F	8052	
CMX 250 CT	(MC13)	96 -	250	VD05F	8052	
CMX 450 C			450	XD05F	8072	
CR 125 R			125	LB05F/CR2	8051/8048	
CR 250 R		- 81	250	LB05F/CR2	8051/8048	
CR 250 R		82 - 02	250	LB05F/CR2	8051/8048	
CR 80 R		- 85	80	LB05EMH	8160	
CR 80 R		86 -	80	LB05EMH	8160	
CT 70		92 -	70	LD05F	8060	
CY 50		01.81 -	50	LD05F	8060	
CY 80			80	LD05F	8060	
Elite 50/S			50	LB05F	8051	
EZ 90		93 -	90	LB05F	8051	
FMX 650		05 -	650	SD05F	8022	
FT 500	(PC07)	01.82 - 12.85	500	VD05F	8052	
GB 500	(PC16)	92 -	500	SD05F	8022	
GL 1000	(GL1)		1000	XD05F	8072	
GL 1100	(SC02)	82 -	1100	XD05F	8072	
GL 1100	(SC02)	- 81	1100	XD05F	8072	

Order-
No.

						HONDA
GL 1100 DX (SC02)		82 -	1100	XD05F	8072	
GL 1100 DX (SC02)		- 81	1100	XD05F	8072	
GL 1100 R			1100	XD05F	8072	
GL 1200 (SC14)		84 - 87	1200	XD05F	8072	
Italia 125 (I)			125	LD05F	8060	
Lead 125 (JF01)			125	LB05F/CR2	8051/8048	
MB 50 F (AC01)			50	LB05F	8051	
MB 50 S (AC01)			50	LB05F	8051	
MB 80 (HC01)		01.80 -	80	LB05F	8051	
MBX 125 F			125	SD05FM	8392	
MBX 50 M (AC05)			50	LB05EMH	8160	
MBX 50 S (AC05)			50	LB05EMH	8160	
MBX 50 SD (AC05)			50	LB05EMH	8160	
MBX 80 SWD/SW2D (HC04)		87 -	80	LB05F	8051	
MCX 80 (HC05)		01.80 -	80	LB05F	8051	
MR 50			50	LB05F	8051	
MT 50 F (AD04)			50	LB05F	8051	
MT 50 S (AD04)			50	LB05F	8051	
MT 80 F			80	LB05F	8051	
MT 80 S (HD02)			80	LB05F	8051	
MTX 125			125	LB05EMH	8160	
MTX 125 R (I)			125	LB05F	8051	
MTX 125 R2 (I)			125	LB05F	8051	
MTX 200 RW (MD07)		83 - 85	200	LB05EMH	8160	
MTX 50 R			50	LB05EMH	8160	
MTX 50 S		86 -	50	LB05EMH	8160	
MTX 80 C		82 -	80	LB05EMH	8160	
MTX 80 R (D) (HD08)			80	LB05EMH	8160	
MTX 80 R (F) (HD08)			80	LB05EMH	8160	
MTX 80 R II (HD09)		87 -	80	LB05EMH	8160	
MTX 80 RS (HD08)		83 - 85	80	LB05EMH	8160	
NC 50			50	LB05F	8051	
NE 50			50	LB05F	8051	
NE 50 Vision		90 -	50	LB05F	8051	
NH 90 M		93 -	90	LB05F	8051	
NH 90 Yupy		90 -	90	LB05F	8051	
NR 750 (RC40)		93 -	750	SD05F	8022	
NS 125 F (I)			125	LB05EMH	8160	
NS 125 R (I)			125	LB05F	8051	
NS-1		96 -	75	LB05F	8051	
NSR 125 F			125	LB05F	8051	
NSR 50		89 -	50	LB05F	8051	
NSR 80			80	LB05F	8051	
NT 50			50	LB05F	8051	
NTV 600			600	SD05F/VD05F	8022/8052	
NX 250 J (MD21)		88 -	250	VD05F	8052	
NX 250 K (MD21)		89 -	250	VD05F	8052	
NX 250 L (MD25)		91 -	250	VD05F	8052	
NX 50			50	LB05F	8051	
NX 50 M			50	LB05F	8051	
NX 650 (RD02)/Dominator		88 -	650	SD05F	8022	
NX 650 Dominator (RD08)(I)		01.88 -	650	SD05F	8022	

Order-
No.

HONDA					
PA 50		84 -	50	LB05F	8051
PC 800	Pacific Coast	98 -	800	SD05F	8022
PF 50			50	LB05F	8051
PK 50 DX	(AB25)	95 -	50	LB05F	8051
PK 50 Walloroo		90 -	50	LB05F	8051
PM 50			50	LB05F	8051
PX 50		84 -	50	LB05F	8051
PX 50 E		80 -	50	LB05F	8051
PX 50 R		85 -	50	LB05F	8051
PZ 50			50	LB05F	8051
RVF (RC45)		94 -	750	SD05F	8022
SA 50	(AF29)		50	LB05F	8051
SE 50			50	LB05F	8051
SFX 50		96 -	50	LB05F	8051
SH 50		01.84 -	50	LB05F	8051
SH 50 T	(AF40)	97 -	50	LB05F	8051
SH 80 E Scoopy		84 -	80	LB05F	8051
SJ 50 Bali			50	LB05F	8051
ST 50 C	(AB23) Dax		50	LD05F	8060
ST 70		94 -	70	LD05F	8060
TL 125			125	VD05F	8052
TLM 50			50	LB05EMH	8160
TLR 250			250	VD05FMH	8425
TRAX 125	(ATV)		125	LD05F	8060
TRX 125	(ATV)		125	VD05F	8052
TRX 200 D	(ATV)	92 -	200	VD05F	8052
TRX 250	(ATV)		250	VD05F	8052
TRX 250 R	(ATV)		250	VD05F	8052
TRX 250 X	(ATV)		250	VD05F	8052
TRX 70	(ATV)		70	LD05F	8060
TRX 90	(ATV)	95 -	90	LD05F	8060
TRX 90	(ATV)	93 - 94	90	LD05F	8060
VF 1000 F		- 86	1000	SD05FMC	30465
VF 1000 F	(SC15)	87 -	1000	SD05FMC	30465
VF 1000 F2	(SC15)	85 -	1000	SD05FMC	30465
VF 1000 R	(SC16)	84 - 86	1000	SD05FMC	30465
VF 1100 C	(SC12)	83 -	1100	SD05FMC/CR1	30465/8035
VF 500 F	(PC12)	84 -	500	SD05FMC/CR1	30465/8035
VF 500 F2	(PC12)	85 -	500	SD05FMC/CR1	30465/8035
VF 500 F2	(PC12)	- 84	500	SD05FMC/CR1	30465/8035
VF 750 C		95 - 00	750	SD05F/CR1	8022/8035
VF 750 C Magna		94 - 95	750	CR1	8035
VF 750 F	(RC15)	83 - 84	750	CR1	8035
VF 750 S	(RC07)	82 - 83	750	SD05F	8022
VFR 750 F		94 -	750	XD05F	8072
VFR 750 F (I)			750	XD05F	8072
VFR 750 F	(RC24)	86 - 87	750	XD05F	8072
VFR 750 F	(RC24)	88 - 89	750	XD05F	8072
VFR 750 F	(RC36)	90 - 94	750	XD05F	8072
VFR 750 FJ (I)			750	XD05F	8072
VT 250 F2			250	SD05FMC	30465
VT 500 C	(PC08)	83 -	500	VD05F	8052

Order-
No.

					HONDA	
VT 500 E	(PC11)	83 - 85	500	VD05F		8052
VT 750 C	(RC29)	87 -	750	XD05F/VD05F		8072/8052
VT 750 C/C2V	(RC44)	97 -	750	XD05F/VD05F		8072/8052
XL 125 (I)			125	LD05F		8060
XL 125 R			125	VD05FMH		30570
XL 125 S			125	LD05F		8060
XL 185 S		01.79 -	185	VD05F		8052
XL 200 R		01.83 -	200	VD05F		8052
XL 250 R	(MD11)	- 83	250	SD05F/CR1		8022/8035
XL 250 R	(MD11)	84 - 85	250	SD05F/CR1		8022/8035
XL 250 R	(MD11)	86 -	250	SD05F/CR1		8022/8035
XL 350 R	(ND03)	85 - 87	350	VD05F		8052
XL 50		01.80 -	50	LD05F		8060
XL 500 R	(PD02)	86 -	500	VD05F		8052
XL 500 R	(PD02)	- 85	500	VD05F		8052
XL 500 S	(PD01)	01.79 - 1281	500	VD05F		8052
XL 600 L			600	SD05FM		8392
XL 600 LM	(PD04)	85 - 87	600	SD05FM		8392
XL 600 R	(PD03)	83 - 87	600	SD05FM		8392
XL 600 RM (I)			600	SD05FM		8392
XL 600 RM	(PD04)	86 -	600	SD05FM		8392
XL 600 V / VN		87 -	600	SD05F		8022
Transalp XL 650		94 -	650	SD05F		8022
XL 650L		94 -	650	SD05F		8022
XLR 125 R		98 -	125	VD05FMH		8425
XR 100R		92 -	100	VD05F		8052
XR 125			125	LD05F		8060
XR 250 L		92 -	250	SD05F		8022
XR 350 R			350	VD05F		8052
XR 50		93 - 02	50	LD05F		8060
XR 500			500	VD05F		8052
XR 500 R			500	VD05F		8052
XR 600 / V			600	SD05FM		8392
XR 600 R / L		01.87 -	600	SD05FM		8392
XR 80R		92 -	80	LB05F		8051
Z 50 GZ		01.80 - 12.84	50	LD05F		8060
Z 50 J			50	LD05F		8060
Z 50 R		94 -	50	LD05F		8060
ZB 50 P	(AB22)	88 -	50	VD05F		8052
					HUSQVARNA	
410 TE (2AA)		96 - 00	400	SD05FP		8325
610 e TE/TC		98 -	610	SD05FP		8325
CR 250		01 -	250	LB05F/CR2		8051/8048
SM 570 R		01 -	570	SD05FP		8325
SM 610 e		98 -	610	SD05FP		8325
TC 570		07.01 -	576	SD05FP		8325
TE 410		01 -	400	SD05FP		8325
TE 570		07.01 -	576	SD05FP		8325
WR 250		01 -	250	LB05F/CR2		8051/8048

Order-
No.**KAWASAKI**

750 Turbo	01.73 - 12.86	750	LB05F	8051
AE 50	- 82	50	LB05F	8051
AE 50	83 -	50	LB05F	8051
AE 80	83 -	80	LB05F	8051
AE 80	- 82	80	LB05F	8051
AN 80		80	LB05F	8051
AR 125	01.82 -	125	LB05F	8051
AR 50	93 -	50	LB05F	8051
AR 50	- 82	50	LB05F	8051
AR 50	83 - 92	50	LB05F	8051
AR 80	83 -	80	LB05F	8051
AR 80	- 82	80	LB05F	8051
AV 50	- 83	50	LB05F	8051
AV 50	84 -	50	LB05F	8051
BJ 250A (Estrella)	93 - 96	250	LD05F	8060
BJ 250 C(Estrella)	97 -	250	LD05F	8060
DX 125		125	LB05F	8051
DX 80		80	LB05F	8051
EN 400 A		400	XD05F	8072
EN 450 A (I)		450	XD05F	8072
EN 500	90 -	500	XD05F	8072
EX 500 (GPZ 500S EN 500)	93 -	500	XB05F	8062
GPX 750 R	01.87 -	750	SD05F/CR1	8022/8035
GPX 750 R (I)		750	SD05F/CR1	8022/8035
GPZ 1100		1100	XB05F(IN)YB05F(OUT)	8062/8082
GPZ 1100 (ZX1100E1E1H)	95 -	1100	XB05F(IN)YB05F(OUT)	8062/8082
GPZ 1100 ABS (ZX1100F1)	97 -	1100	XB05F(IN)YB05F(OUT)	8062/8082
GPZ 250 Belt Drive		250	LD05F	8060
GPZ 250 R		250	LD05F	8060
GPZ 305 Belt Drive	01.83 -	305	LD05F	8060
GPZ 400		400	XD05F	8072
GPZ 400 F		400	XD05F	8072
GPZ 400 F II		400	XD05F	8072
GPZ 550		550	LD05F	8060
GPZ 550 Unitrack (I)		550	LD05F	8060
GPZ 750	01.82 -	750	LB05F	8051
GPZ 750 R	01.85 -	750	SD05F/CR1	8022/8035
GPZ 900 R		900	XD05F(IN)LD05F(OUT)	8072/8060
GPZ 900 R (I)		900	XD05F(IN)LD05F(OUT)	8072/8060
KC 100	80 -	100	LB05F	8051
KC 125		125	LB05F	8051
KC 90		90	LB05F	8051
KC 90 A		90	LB05F	8051
KC 90 C		90	LB05F	8051
KC 90 D		90	LB05F	8051
KD 100		100	LB05E	8031
KD 125		125	LB05E	8031
KD 175		175	LB05F	8051
KD 80		80	LB05F	8051
KDX 125 SR		125	LB05F/CR2	8051/8048
KDX 175	01.80 - 12.84	175	LB05F	8308
KDX 200	93 - 94	200	LB05F	8308

Order-
No.

KAWASAKI					
KDX 200 H		95 -	200	LB05EMH	8160
KDX 250 (ATV)		91 -	250	LB05F	8051
KDX 250 (ATV)			250	LB05F	8308
KDX 250 SR (ATV)		92 -	250	LB05F	8051
KDX 80			80	LB05F	8051
KE 100		01.76 - 12.79	100	LB05F	8051
KE 100		93 -	100	LB05F	8051
KE 125		01.76 - 12.83	125	LB05E	8031
KE 175		81 -	175	LB05F	8051
KE 175		- 80	175	LB05F	8051
KE 175 B			175	LB05F	8051
KE 175 D			175	LB05F	8051
KE 250			250	LB05E	8031
KE 90			90	LB05F	8051
KEF 300 A&B (ATV) (SQ)		95 -	300	LD05F	8060
KH 100			100	LB05F	8051
KH 125		01.77 - 12.81	125	LB05F	8051
KH 125		93 -	125	LB05F	8051
KH 250		01.73 - 12.79	250	LB05E	8031
KH 400			400	LB05E	8031
KH 50			50	LB05F	8051
KH 500			500	LB05E	8031
KH 80			80	LB05F	8051
KH 90			90	LB05F	8051
KL 250 (A)		01.79 - 12.83	250	LB05F	8051
KLE 400		93 -	400	XD05F	8072
KLF 185 (ATV)			185	LD05F	8060
KLF 220 (ATV)		88 - 02	220	LD05F	8060
KLF 300 (ATV)		88 -	300	LB05F	8051
KL 250 (KLR 250)		01.83 - 91	250	LD05F	8060
KLR 650		09.86 - 94	650	XD05F	8072
KLR 650 (KL650C1/C3)		95 -	650	XD05F	8072
KLX 250		01.80 - 12.84	250	LB05E	8031
KLX 250 (KLX250E)		93 -	250	XD05F	8072
KLX 650 (KLX650C)		93 -	650	SD05FM	8392
KLX 650 R		98 -	650	SD05FM	8392
KLX 650 R (KLX650A)		93 - 96	650	SD05FM	8392
KM 100		01.79 - 12.81	100	LB05E	8031
KM 90			90	LB05F	8051
KMX 125		01.86 -	125	LB05F	8051
KMX 200		01.88 - 92	200	LB05F/CR2	8051/8048
KMX 50 (KSR-1)		93 -	50	LB05F	8051
KMX 80 (KSR-2)		93 -	80	LB05F	8051
KR-1R			250	LB05F	8051
KR-1S			250	LB05F	8051
KS 125		01.73 - 12.76	125	LB05E	8031
KT 250			250	LB05E	8031
KV 100			100	LB05E	8031
KX 125		91 - 99	125	LB05EMH	8160
KX 125		85 - 90	125	LB05F	8051
KX 125		90 - 91	125	LB05EMH	8160
KX 125		82 - 84	125	LB05F	8051

Order-
No.

KAWASAKI					
KX 125	(KX125K4)	97 -	125	LB05EMH	8160
KX 250		- 91	250	LB05F	8051
KX 400			400	LB05F	8308
KX 500		93 -	500	LB05F	8308
KX 60		- 92	60	LB05F	8051
KX 60		93 -	60	LB05F	8051
KX 80		- 80	80	LB05F	8308
KX 80		83 - 91	80	LB05F	8308
KX 80		81 - 82	80	LB05F	8308
KX 80	(KX80S7)	97 -	80	LB05F	8308
KX 80	(KX80V7)	97 -	80	LB05F	8308
KX 80 /80-2		92 -	80	LB05F	8308
KZ 1000 Police		93 -	1000	XB05F(IN)LB05FP(OUT)	8062/8030
LTD 250 Belt Drive			250	LD05F	8060
LTD 400			400	LD05F	8060
LTD 450		01.85 -	450	LD05F	8060
LTD 550		01.80 - 12.85	550	LD05F	8060
LTD 700			700	LB05F	8051
LTD 750 4 Cyl.		01.82 - 12.87	750	LB05F	8051
LX 250			250	LB05F	8051
MULE 500/ KAF 300 A&B	(UV)	92 - 96	300	LB05F	8051
VN 750 Twin			750	XD05F(IN)LD05F(OUT)	8072/8060
VN 750 Vulcan			750	XD05F(IN)LD05F(OUT)	8072/8060
VN-15 A/B (VN-1500/SE/C/D2)			1500	XD05F(IN)LD05FP(OUT)	8072/8070
Z 1			900	SB05F(IN)YB05F(OUT)	8080/8082
Z 1000		- 80	1000	LB05F	8051
Z 1000		81 -	1000	LB05F	8051
Z 1000 ES (I)			1000	LB05F	8051
Z 1000 J (I)			1000	LB05F	8051
Z 1100			1100	XB05F(IN)YB05F(OUT)	8062/8082
Z 2			750	XD05F(IN)LD05F(OUT)	8072/8060
Z 200		01.77 - 12.79	200	LB05F	8051
Z 250			250	LB05F	8051
Z 250 A		01.80 -	250	LD05F	8060
Z 250 B			250	LD05F	8060
Z 250 Belt Drive			250	LD05F	8060
Z 250 C		01.80 -	250	LB05F	8051
Z 250 D			250	LB05F	8051
Z 250 G			250	LB05F	8051
Z 250 J			250	LD05F	8060
Z 250 LTD		01.81 -	250	LB05F	8051
Z 250 T			250	LD05F	8060
Z 305			305	LD05F	8060
Z 400		01.76 - 12.81	400	LB05F	8051
Z 400 A/B/C/D/G/H			400	LB05F	8051
Z 400 F			400	LD05F	8060
Z 400 F		83 -	400	LD05F	8060
Z 400 F-II			400	LD05F	8060
Z 400 J			400	LD05F	8060
Z 400 J (I)			400	LD05F	8060
Z 400 K			400	LD05F	8060
Z 400 LTD			400	LB05F	8051

Order-
No.

				KAWASAKI
Z 400 M		400	LD05F	8060
Z 440	01.80 - 12.85	440	LB05F	8051
Z 440 H (I)		440	LB05F	8051
Z 500		500	LD05F	8060
Z 550		550	LD05F	8060
Z 650		650	LB05F	8051
Z 650 F-B		650	LB05F	8051
Z 750		750	LB05F	8051
Z 900	01.73 - 12.76	900	SB05F(IN)YB05F(OUT)	8080/8082
Zephyr 1100 (ZR1100A)		1100	SD05FM	8392
ZL 1000	09.86 -	1000	SD05FM	8392
ZL 400 (Eliminator 400SE)	93 -	400	LD05F	8060
ZL 600	01.86 -	600	XD05F	8072
ZL 600 (ZL600B/B1)	95 -	600	XD05F	8072
ZR 250 (Balius)	93 -	250	SD05F/CR1	8022/8035
ZR 400	84 -	400	LD05F	8060
ZR 400	- 83	400	LD05F	8060
ZR 400-C (Zephyr 400)	93 -	400	LD05F/CR2	8060/8048
ZR 400-D (Xanthus)	93 -	400	LD05F	8060
ZR 500		500	LD05F	8060
ZR 550 B Zephyr	91 -	550	LD05F	8060
ZR 750 C Zephyr	91 - 00	750	LD05FP	8070
ZR 750 D1/2 Zephyr	96 - 00	750	LD05FP	8070
ZRX 1100 (ZR1100C1)(ZRT10C)	97 - 00	1100	SD05FM	8392
ZX 10	87 - 90	1000	SD05FM	8392
ZX 400 (Z 400-F2)	93 -	400	LD05F	8060
ZX 550 A1		550	LD05F	8060
ZX 600 A (I)		600	LD05F	8060
ZX 750 J		750	LB05FP	8030
ZX 750 N1 Ninja ZX-7RR	96 -	750	LB05FP	8030
ZX 750 P1/P2 Ninja ZX-7R	96 -	750	LB05FP	8030
Zephyr (ZR 1100 B1)	96 -	1100	SD05FM	8392
ZX-6R Ninja (ZX 600 H Kat)	98 -	600	XD05F	8072
ZX-6R Ninja (ZX600F1/F3)	95 -	600	XD05F	8072
ZX-6R Ninja (ZX 600 G)	98 -	600	XD05F	8072
ZXR 750	09.88 -	750	XD05F	8072
ZXR 750 R	90 -	750	XD05F	8072
ZXR 750 R (ZX750L/M)	93 -	750	XD05F	8072
				KTM
105 SX	04 -	105	TB05EMA	8636
125 EGS	99 -	125	LB05EMH	8160
125 EGS	98 -	125	LB05EMH	8160
125 Enduro		125	LB05F	8051
125 EXC	98 - 99	125	LB05EMH	8160
125 EXC	96 - 08.97	125	LB05EMH	8160
125 EXC	99 - 00	125	LB05EMH	8160
125 EXC	93 - 95	125	LB05EMH	8160
125 EXC	01 -	125	LB05EMH	8160
125 EXC	08.97 - 98	125	LB05EMH	8160
125 EXE	99 -	125	LB05EMH	8160
125 LC 2 (Langgewinde)	96 - 00	125	LB05EMH	8160

Order-
No.

KTM				
125 Sting	98 -	125	LB05EMH	8160
125 Supermoto	99 -	125	LB05EMH	8160
125 SX	96 - 08.97	125	LB05EMH	8160
125 SX	99 - 00	125	LB05EMH	8160
125 SX (98er)	08.97 - 98	125	LB05EMH	8160
125 SX	02 -	125	LB05EMH	8160
200 EGS	98 -	200	LB05EMH	8160
200 EGS	99 -	200	LB05EMH	8160
200 EXC	98 - 99	200	LB05EMH	8160
200 EXC	02 -	200	LB05EMH	8160
200 EXC	99 - 01	200	LB05EMH	8160
200 MXC	99 -	200	LB05EMH	8160
200 SX	03 -	200	LB05EMH	8160
250 DXC		250	LB05EMH	8160
250 EGS	97 -	250	LB05EMH	8160
250 EGS	93 - 95	250	LB05EMH	8160
250 EGS	99 -	250	LB05EMH	8160
250 EGS	98 -	250	LB05EMH	8160
250 Enduro		250	LB05EMH	8160
250 EXC Racing	03 -	250	VD05EG	
250 EXC	93 - 95	250	LB05EMH	8160
250 EXC / Sixt Days	98 - 01	250	LB05EMH	8160
250 EXC Enduro Competition	03 -	250	LB05EMH	8160
250 EXC	97 - 98	250	LB05EMH	8160
250 EXC	96 - 96	250	LB05EMH	8160
250 EXC Racing GS	03 -	250	VD05EG	
250 MX		250	LB05EMH	8160
250 SX	99 -	250	LB05EMH	8160
250 SX	96 -	250	LB05EMH	8160
250 SX	97 - 98	250	LB05EMH	8160
250 SX	98 - 99	250	LB05EMH	8160
250 SX 4Takt	05 -	250	VD05EG	
250 SX	93 - 95	250	LB05EMH	8160
250 SXC	99 -	250	LB05EMH	8160
300 EGS	99 -	300	LB05EMH	8160
300 EXC / Sixt Days	99 -	300	LB05EMH	8160
300 EXC Enduro Competition	03 -	300	LB05EMH	8160
300 EXC	97 - 98	300	LB05EMH	8160
300 MXC	03 -	300	LB05EMH	8160
300 SX	99 -	300	LB05EMH	8160
360 EXC	97 -	360	LB05EMH	8160
360 MXC	97 -	360	LB05EMH	8160
360 SX	96 -	360	LB05EMH	8160
360 SX	97 -	360	LB05EMH	8160
380 Enduro	98 -	380	LB05EMH	8160
380 EGS	98 -	380	LB05EMH	8160
380 EGS	99 -	380	LB05EMH	8160
380 EXC	98 -	380	LB05EMH	8160
380 SX	99 -	380	LB05EMH	8160
400 Enduro-E	98 -	400	SD05F	8022
400 EGS	97 -	400	SD05F	8022
400 EGS-E	97 -	400	SD05F	8022

Order-
No.

				KTM
400 EXC Racing	03 -	400	VD05EG	
400 EXC Racing	99 - 04.02	400	VD05F	8025
400 LC4-E	99 - 04.02	400	SD05F	8022
400 LC4	99 - 04.02	400	SD05F	8022
400 LS-E	97 - 04.02	400	SD05F	8022
400 SC	98 -	400	SD05F	8022
400 SC	96 -	400	SD05F	8022
400 SX	98 - 04.02	400	SD05F	8022
400 SX Racing / Six Days	99 - 04.02	400	VD05F	8025
400 SXC	98 - 04.02	400	SD05F	8022
400 SXC	99 - 04.02	400	SD05F	8022
400 SXC 20kW	99 - 04.02	400	SD05F	8022
450 EXC Racing GS	03 -	450	VD05EG	
450 EXC Racing	03 -	450	VD05EG	
450 MXC GS	03 -	450	VD05EG	
450 MXC Dessert	03 -	450	VD05EG	
450 SX Racing	03 -	450	VD05EG	
50 GP	10.81 -	50	LB05F	8051
50 GXE		50	LB05F	8051
50 SX Pro Junior LC Beta Engine	03 -	50	LB05EMH	8160
50 ME	10.81 -	50	LB05F	8051
50 MLS		50	LB05F	8051
50 MMS		50	LB05F	8051
50 MS	10.81 -	50	LB05F	8051
50 RSL		50	LB05F	8051
50 Senior	03 -	50	LB05EMH	8160
50 SX Pro Senior LC	03 -	50	LB05EMH	8160
520 EXC Racing / Six Days	99 - 04.02	520	VD05F	8025
520 SX Racing	99 - 04.02	520	VD05F	8025
525 EXC Racing	03 -	525	VD05EG	
525 EXC Racing GS	03 -	525	VD05EG	
525 MXC	03 -	525	VD05EG	
525 SX Racing	03 -	525	VD05EG	
540 SXC	98 -	540	SD05F	8022
540 SXC	99 -	540	SD05F	8022
540 SXC 20kW	99 -	540	SD05F	8022
540 SXS Racing	02 -	540	VD05F	8025
60 SX	98 -	60	LB05EMH	8338
600 Country		600	LD05F	8060
600 Enduro		600	LD05F	8060
600 MX		600	LD05F	8060
620 Duke	94 -	609	LD05F	8060
620 Duke-E	97 -	620	SD05F	8022
620 EGS	97 -	620	SD05F	8022
620 EGS-E	97 -	620	SD05F	8022
620 LS4 Rally	97 -	620	SD05F	8022
620 LS-E	97 -	620	SD05F	8022
620 SC	96 -	620	SD05F	8022
620 SC	98 -	620	SD05F	8022
620 Supercompetition	97 - 04.02	620	SD05F	8022
620 SX	96 -	620	SD05F	8022
620 SX	99 -	620	SD05F	8022

Order-
No.

KTM				
625 SC	02 -	625	SD05F	8022
625 SXC Hard Enduro	03 -	625	SD05EG	
625 SXC Super Moto	02 -	625	SD05F	8022
640 Duke 2	02 - 04.02	625	SD05F	8022
640 Supermoto Spezial Edition	03 -	625	SD05EG	
65 SX Beta Engine	03 -	65	LB05EMH	8160
65 SX	98 - 00	65	LB05EMH	8338
660 Rallye	02 - 04.02	650	SD05F	8022
660 Super Moto Factory Replica	02 -	650	SD05F	8022
80 Chopper		80	LB05F	8051
80 Enduro		80	LB05F	8051
80 PL	06.83 - 12.84	80	LB05F	8051
80 RL	10.81 -	80	LB05F	8051
80 RLS	10.81 -	80	LB05F	8051
80 RLW	10.81 -	80	LB05F	8051
80 RS	10.81 -	80	LB05F	8051
85 SX	04 -	85	TB05EMA	8636
Adventure R 640	98 - 01	625	SD05F	8022
Bora 25	10.81 -	50	LB05F	8051
Bora 50		50	LB05F	8051
Bora 80	10.81 -	80	LB05F	8051
Comet	09.76 -	50	LB05F	8051
Crazy (CH)		50	LB05F	8051
Duke 2	00 - 04.02	625	SD05F	8022
Duke 640	98 - 01	625	SD05F	8022
Duke II	99 - 01	625	SD05F	8022
Foxi		50	LB05F	8051
Foxi (DK)		50	LB05F	8051
GS 100	08.73 - 08.76	100	LB05F	8051
GS 125 12,7 mm		125	LB05F	8051
GS 175		175	LB05F	8051
GS 250 12,7 mm		250	LB05F	8051
GS 400		400	LB05F	8051
GS 500 2Stroke		500	LB05F	8051
GS 500 4Stroke		500	LD05F	8060
Hobby	10.81 -	50	LB05F	8051
LC4- E 400 Enduro	01 -	400	SD05F	8022
LC4 620 SC Supermoto	01 - 04.02	609	SD05F	8022
LC4 620 Supercompetition	01 - 04.02	609	SD05F	8022
LC4 612 EXC	93 -	612	LD05F	8060
LC4 612 EGS	93 -	612	LD05F	8060
LC4 Super Competition	00 - 04.02	620	SD05F	8022
LC4 620 EXC	94 -	620	SD05F	8022
LC4 620 SX	94 -	620	SD05F	8022
LC4 620 EGS	94 -	620	SD05F	8022
LC4- E 640 Supermoto	01 - 01	625	SD05F	8022
640 LC4 Super Moto	02 - 04.02	625	SD05F	8022
LC4 640	98 - 00	625	SD05F	8022
640 LC4	02 - 04.02	625	SD05F	8022
LC4-640 Hard Enduro	03 -	625	SD05EG	
LC4- E Supermoto	00 - 00	625	SD05F	8022
LC4 Adventure	00 - 00	625	SD05F	8022

Order-
No.

					KTM
LC4- E	00 - 00	625	SD05F	8022	
LC4- E 640 Enduro	01 - 01	625	SD05F	8022	
640 LC4-E Six Days	02 -04.02	625	SD05F	8022	
640 LC4-E SM Prestige	02 -04.02	625	SD05F	8022	
LC4 640 Duke II	03 -	625	SD05EG		
640 LC4 Adventure	02 -04.02	625	SD05F	8022	
LC4- 640 Adverture	01 -04.02	625	SD05F	8022	
640 LC4	99 - 01	625	SD05F	8022	
660 LC4 Rallye	99 - 01	650	SD05F	8022	
LC4 Enduro 17kW	- 87	600	LD05F	8060	
LC4 Enduro 36kW	- 87	600	LD05F	8060	
LC4 400	98 -	400	SD05F	8022	
LC4 400 EGS	93 -	400	SD05F	8022	
LC4 400 EXC	93 -	400	SD05F	8022	
LC4 600 EGS	93 -	600	LD05F	8060	
LC4 600 EXC	93 -	600	LD05F	8060	
LC4 Competition	98 -	400	SD05F	8022	
MC 100	08.73 -08.76	100	LB05F	8051	
MC 125 12,7 mm		125	LB05F	8051	
MC 125 19,0 mm		125	LB05F	8051	
MC 125 GP		125	LB05F	8051	
MC 175		175	LB05F	8051	
MC 250 12,7 mm		250	LB05F	8051	
MC 250 19,0 mm		250	LB05F	8051	
MC 250 GP 12,7 mm		250	LB05F	8051	
MC 250 GP 19,0 mm		250	LB05F	8051	
MC 400		400	LB05F	8051	
MC 400 GP		400	LB05F	8051	
MC 500 2Stroke		500	LB05F	8051	
MC 500 4Stroke		500	LD05F	8060	
Pony	10.81 -	50	LB05F	8051	
Pony (CH)	10.81 -	50	LB05F	8051	
Postmofa		50	LB05F	8051	
Rallye	00 - 01	650	SD05F	8022	
SM 25		50	LB05F	8051	
Squadra		50	LB05F	8051	
Supermoto Competition 620	98 - 00	620	SD05F	8022	
					MAICO
250	94 -	250	LBER	8308	
320	94 -	320	LBER	8308	
440	94 -	440	LBER	8308	
500	94 -	500	LBER	8308	
685 Gespann	94 -	685	LBER	8308	
GM Star 250		250	LBER	8308	
GM Star E 250		250	LBER	8308	
GS 125		125	LBER	8308	
GS 250		250	LBER	8308	
GS 400	01.74 -05.83	400	LBER	8308	
GS 500		500	LBER	8308	
GS Star 500		500	LBER	8308	
GS Star E 500		500	LBER	8308	

Order-
No.**MAICO**

GSE 250	-05.83	250	LB05F	8308
GSE 490	-05.83	490	LB05F	8308
MC 125		125	LB05F	8308
MC 250		250	LB05F	8308
MC 400		400	LB05F	8308
MC 490	-05.83	490	LB05F	8308
MC 500		500	LB05F	8308
SG 125		125	LB05F	8308

MBK

125 12,7 mm		125	LB05F	8051
125 19,0 mm		125	LB05F	8051
151 L	01.79 - 07.83	50	LB05F	8051
151 LB	01.79 - 07.83	50	LB05F	8051
151 LC	01.79 - 07.83	50	LB05F	8051
250		250	LB05F	8051
350	04.73 - 04.79	350	LB05F	8051
350 E		350	LB05F	8051
350 Injection		350	LB05F	8051
41		49	LB05F	8051
50 EV		49	LB05F	8051
50 EW		49	LB05F	8051
50 L		49	LB05F	8051
50 R		50	LB05F	8051
50 S		49	LB05F	8051
50 VL		49	LB05F	8051
50 VL	01.71 - 12.80	50	LB05F	8051
50 VLC	01.71 - 12.80	50	LB05F	8051
50 VS		49	LB05F	8051
51 New West		49	LB05F	8051
51 S		49	LB05F	8051
51 SL		49	LB05F	8051
51 SU	01.81 - 07.83	50	LB05F	8051
51 Super		49	LB05F	8051
51 Super Special		49	LB05F	8051
51 V		49	LB05F	8051
51 VL		49	LB05F	8051
88		49	LB05F	8051
88 IP		49	LB05F	8051
88 IU		49	LB05F	8051
89		49	LB05F	8051
89	-07.83	50	LB05F	8051
93		50	LB05F	8051
98	-07.83	50	LB05F	8051
99		50	LB05F	8051
Active		49	LB05F	8051
AV 40		49	LB05F	8051
AV 42		49	LB05F	8051
AV 44		49	LB05F	8051
AV 46		49	LB05F	8051
AV 48		49	LB05F	8051
AV 56		49	LB05F	8051

Order-
No.**MBK**

AV 59		49	LB05F	8051
AV 65		49	LB05F	8051
AV 68		49	LB05F	8051
AV 76		49	LB05F	8051
AV 79		49	LB05F	8051
AV 85		49	LB05F	8051
AV 88		49	LB05F	8051
AV 89		49	LB05F	8051
AV 92		49	LB05F	8051
AV 98		49	LB05F	8051
Cady		49	LB05F	8051
CF		49	LB05F	8051
Champ		49	LB05F	8051
D50		50	LB05F	8051
D75		75	LB05F	8051
Daytona Beach		49	LB05F	8051
Daytona Cruiser		49	LB05F	8051
FXK		49	LB05F	8051
G 40		49	LB05F	8051
G 50		49	LB05F	8051
Hobby IV		49	LB05F	8051
KW Magnum		49	LB05F	8051
M 1		49	LB05F	8051
M 1L		49	LB05F	8051
M 1P		49	LB05F	8051
M 1PR		49	LB05F	8051
M 1PRT		49	LB05F	8051
M 1PRTS		49	LB05F	8051
Mobylett		49	LB05F	8051
Monty MB3V	01.77 - 07.83	50	LB05F	8051
Monty SP3V	- 11.81	50	LB05F	8051
Monty SP3V	12.81 -	50	LB05F	8051
N 40		49	LB05F	8051
N 50		49	LB05F	8051
Rock		49	LB05F	8051
SP 50		49	LB05F	8051
SP 92		49	LB05F	8051
SP 93		49	LB05F	8051
SP 94		49	LB05F	8051
SP 94 TT		50	LB05F	8051
SP 98		49	LB05F	8051
SP 99		49	LB05F	8051
Weeky		49	LB05F	8051
X 1		49	LB05F	8051
X 1L		49	LB05F	8051
X 7L		49	LB05F	8051
X 7S		49	LB05F	8051
X 7VL		49	LB05F	8051
X 7VS		49	LB05F	8051
ZX		49	LB05F	8051

Order-
No.**MONTESA**

Brio,Cirlo,Fura,Mini Cota		50	LB05F	8051
Cota 123/C/T, Cota 125		123	LB05F	8051
Cota 172/200		175	LB05F	8051
Cota 25A/25C/49,Mini Mont. 315R	97 -	50	LB05F	8051
		315	LB05F	8051
Cota 330,Trial		330	LB05F	8051
Cota 335/335E/349/349T/350		350	LB05F	8051
Cota 348,Trial		310	LB05F	8051
Cota 74 /74T /80		75	LB05F	8051
Crono 350		350	LB05F	8051
Crono 75		75	LB05F	8051
Enduro 360 H6/H7/H7S/L		350	LB05F	8051
Enduro 75 H6 /H7/ L		75	LB05F	8051
Scorpion 50R		50	LB05F	8051

MOTO GUZZI

1000 SP III	88 - 92	1000	LB05F	8051
250 FD	74 - 76	250	LD05F	8060
250 TS	01.74 - 07.80	250	LB05F	8051
850 California	12.75 - 12.81	850	LB05F	8051
850 Le Mans II / III	01.78 - 12.81	850	LB05F	8051
850 T4	07.80 - 12.83	850	LB05F	8051
850 T5	06.83 - 12.87	850	LB05F	8051
850 TS 5	82 - 84	850	LB05F	8051
V 35 II	12.80 - 01.87	350	LB05F	8051
V 35 III	07.85 -	350	LB05F	8051
V 35 Imola	11.79 - 01.87	350	LB05F	8051
V 35 Imola II	79 - 86	350	LB05F	8051
V 65 NTX	90 - 92	650	LB05F	8051
V 65 Polizia NT		650	LB05F	8051
V 65 SP	- 86	650	LB05F	8051

MOTOR HISPANIA

Minicross		50	LB05F	8051
Style		50	LB05F	8051

MZ

ETZ 301 Classic	17kW	301	LB05F	8051
ETZ Classic	13/15kW	251	LB05F	8051
Saxon 301 Fun	17kW	301	LB05F	8051
Saxon 251 Fun	13/15kW	251	LB05F	8051
Saxon Roadstar	7kW	125	LB05F	8051
Saxon Roadstar	9kW	150	LB05F	8051
Saxon Sportstar	9kW	150	LB05F	8051
Saxon Sportstar	7/11kW	125	LB05F	8051
Saxon 301 Tour	17kW	301	LB05F	8051
Saxon 251 Tour	13/15kW	251	LB05F	8051

PEUGEOT

101	04.75 -	50	LB05F	8051
102	04.75 -	50	LB05F	8051
103	04.75 -	50	LB05F	8051

Order-
No.

				PEUGEOT
103 CRX			50	LB05F 8051
103 LC			50	LB05F 8051
103 LSM-D	06.82 -		50	LB05F 8051
103 MP/MR			50	LB05F 8051
103 Racen			50	LB05F 8051
103 SP	86 -		50	LB05F 8051
103 SPM-D	04.75 -		50	LB05F 8051
103 T16			50	LB05F 8051
103 TXLC, TXR			50	LB05F 8051
103 Vogue			50	LB05F 8051
103 XP,XPLC	01.86 -		50	LB05F 8051
104			50	LB05F 8051
105			50	LB05F 8051
SC80L	06.82 -		80	LB05F 8051
SX8T	02.78 - 12.82		80	LB05F 8051
				POLARIS
Big Boss (ATV)	89 - 93	244	LB05EZ	8744
Big Boss (ATV)	93 -	350	LB05EZ	8744
Big Boss 400L (6X6) (ATV)	95 - 97	379	LB05EZ	8744
Big Boss 500 (6X6) (ATV)	98 -	500	LB05EZ	8744
Cyclone (ATV)	88 - 89	244	LB05EZ	8744
Magnum (2X4) (ATV)	95 -	425	LB05EZ	8744
Magnum (4X4) (ATV)	95 -	425	LB05EZ	8744
Magnum (6X6) (ATV)	96 - 97	425	LB05EZ	8744
Magnum 500 (ATV)	99 -	500	LB05EZ	8744
Ranger (ATV)	99 -	500	LB05EZ	8744
Scambler 400 (4X4) (ATV)	94 -	379	LB05EZ	8744
Scrambler (ATV)	89 - 93	244	LB05EZ	8744
Scrambler 500 (ATV)	98 -	500	LB05EZ	8744
Sport 400 (ATV)	98 -	379	LB05EZ	8744
Sport ATV (ATV)	95 - 97	379	LB05EZ	8744
Sportsman 335 (ATV)	99 -	334	LB05EZ	8744
Sportsman 4x4 (ATV)	94 - 97	379	LB05EZ	8744
Sportsman 500 (ATV)	96 -	500	LB05EZ	8744
Trail Blazer (ATV)	90 -	244	LB05EZ	8744
Trail Boss (ATV)	85 -	244	LB05EZ	8744
Trail Boss (ATV)	90 - 93	350	LB05EZ	8744
Xplorer 300 (ATV)	94 -	283	LB05EZ	8744
Xplorer 400/400L 4x4 (ATV)	94 -	379	LB05EZ	8744
Xplorer 500 (ATV)	97 -	500	LB05EZ	8744
Xpress 300 (ATV)	94 -	283	LB05EZ	8744
Xpress 400 L 2x4 (ATV)	96 - 97	379	LB05EZ	8744
				PUCH
Cobra 12,9 mm	81 -	80	LB05F	8051
Cobra 19,0 mm	81 -	80	LB05F	8051
				RIEJU
RR 50 AM6			50	LB05F 8051
RS 1			50	LB05F 8051

Order-
No.**SACHS**

RS 125	97 -	125	LB05F	8051
ZX 125	97 -	125	LB05F	8051

SUZUKI

A 100	95 -	100	LB05F	8051
A 50 K		50	LB05F	8051
A 50 P		50	LB05F	8051
AE 50	93 -	50	LB05F	8051
AJ 50	95 -	50	LB05F	8051
AJ 50 ZZ	95 -	50	LB05F	8051
AP 50 (CA1JA)	95 -	50	LB05F	8051
CL 50 DO		50	LB05F	8051
CP 50 (CA14C/E)		50	LB05F	8051
CP 50 H-J,L/M/N		50	LB05F	8051
CS 125		125	LD05F	8060
CS 50		50	LB05F	8051
CS 80		80	LB05F	8051
CX 50		50	LB05F	8051
CY 50		50	LB05F	8051
DM 50		50	LB05F	8051
DR 125 S/L-N	91 -	125	LD05F	8060
DR 125 SE (SF44A)	95 -	125	LD05F	8060
DR 125 SJ (SF43B)		125	LD05F	8060
DR 200 SZ	95 -	200	LD05F	8060
DR 250	91 -	250	LD05F	8060
DR 250 S	90 -	250	XD05F	8072
DR 250 S (SJ42A)		250	XD05F	8072
DR 250 SZ	95 -	250	XD05F	8072
DR 250 SZ-H		250	XD05F	8072
DR 400 S	01.80 - 12.83	400	LD05F	8060
DR 600		600	LD05F	8060
DR 600 R Djebel (I)		600	LD05F	8060
DR 600 S (SN41A)		600	LD05F	8060
DR Big 50	89 -	50	LB05F	8051
DS 80	95 -	80	LB05F	8051
DS 80	93 - 94	80	LB05F	8051
DV 50		50	LB05F	8051
FA 50		50	LB05F	8051
FB 100 / D	95 -	100	LD05F	8060
FM 90		90	LB05F	8051
FR 50		50	LB05F	8051
FR 80		80	LB05F	8051
FS 50		50	LB05F	8051
FZ 50		50	LB05F	8051
GN 125 V (NF41A)	97 -	125	LD05F	8060
GN 125	91 -	125	LD05F	8060
GN 400 TD-X		400	LD05F	8060
GP 100		100	LB05F	8051
GP 125		125	LB05F	8051
GR 650 D/XD/XF (GP51A)		650	LD05F	8060
GS 1000 D/E/H/S-1980/GL/GX		1000	XB05F(IN)VB05F(OUT)	8062/8032
GS 125 S		125	LD05F	8060

Order-
No.

				SUZUKI
GS 125 S	99 -	125	LD05F	8060
GS 400 TX		400	VB05F	8032
GS 450 E/ES (GS450)		450	VB05F	8032
GS 450 L (GL51D)		450	VB05F	8032
GS 450 SF		450	VB05F	8032
GS 450 TX		450	VB05F	8032
GS 500 E	- 00	500	XB05F(IN)VB05F(OUT)	8062/8032
GS 500 E (GM51B)	93 - 00	500	XD05F(IN)VD05F(OUT)	8072/8052
GS 750 D/E/L		750	XB05F(IN)VB05F(OUT)	8062/8032
GS 850 G (GS72A)		850	XB05F(IN)VB05F(OUT)	8062/8032
GS 850 GL		850	XB05F(IN)VB05F(OUT)	8062/8032
GSF 400 (BANDIT GK75B)	92 -	400	SD05F/CR1	8022/8035
GSF 400 (BANDIT GK75B)	- 92	400	SD05F/CR1	8022/8035
GSX 1100 EFE (I)		1100	SD05F	8022
GSX 1100 EFG/ESG/EG(GV71C)		1100	SD05F	8022
GSX 1100 EZ/ESD (GU71B)		1100	SD05F	8022
GSX 1100 S/SZ Kata.(GS110XS)		1100	SD05F	8022
GSX 1150 E	86 -	1150	SD05F	8022
GSX 1150 E	- 85	1150	SD05F	8022
GSX 1150 EF		1150	SD05F	8022
GSX 1150 ES		1150	SD05F	8022
GSX 250 L		250	SD05F	8022
GSX 400 E (GS40X)	01.83 -	400	VB05F	8032
GSX 400 FW		400	SD05F/CR1	8022/8035
GSX 400 FX		400	SD05F	8022
GSX 400 LX		400	SD05F	8022
GSX 400 S		400	SD05F	8022
GSX 400 SE/EF (GK53C)		400	SD05F	8022
GSX 550 EF (I)		550	SD05F	8022
GSX 750 E		750	SD05F	8022
GSX 750 E (I)		750	SD05F	8022
GSX 750 EF	- 85	750	SD05F	8022
GSX 750 ES (I)		750	SD05F	8022
GSX 750 S		750	SD05F/CR1	8022/8035
GSX 750 S Katana (I)		750	SD05F/CR1	8022/8035
GSX R 750 (GR75A)	- 87	750	XD05F	8072
GSX R 750 (GR77B)	88 -	750	XD05F	8072
GSX-R 750 (GR7AB)	91 -	750	XD05F	8072
GSX-R400		400	SD05F/CR1	8022/8035
GSX-R400	93 -	400	SD05F/CR1	8022/8035
GT 125,-E		125	LB05F	8051
GT 185		185	LB05F	8051
GT 200		200	LB05F	8051
GT 50		50	LB05F	8051
GT 550	01.73 - 12.77	550	LB05F	8051
GT 80 EX/LX		80	LB05F	8051
JR 50	93 - 94	50	LB10EH	31110
JR 50	95 -	50	LB10EH	31110
K 50		50	LB05F	8051
Katana AY50 aircooled	97 -	50	LB05F	8051
Katana AY50 water (Spain)	97 -	50	LB05F	8051
Katana AY50 watercooled	97 -	50	LB05F	8051

Order-
No.

SUZUKI				
LT 160 E (ATV)	- 92	160	LD05F	8060
LT 160 E (ATV)	93 -	160	LD05F	8060
LT 160 F (ATV)	93 -	160	LD05F	8060
LT 230 E (ATV)	93 -	230	LD05F	8060
LT 230 E/F (ATV)		230	LD05F	8060
LT 230 GE (ATV)		230	LD05F	8060
LT 50 (ATV)		50	LB05F	8051
LT 80 (ATV)		80	LB05F	8051
LT-F 160 (ATV)	95 -	160	LD05F	8060
Maxi 50		50	LB05F	8051
OR 50		50	LB05F	8051
RB 50 GAG	88 - 88	50	LD05F	8060
RG 125	01.85 -	125	LB05F	8051
RG 50 KE		50	LB05F	8051
RG 50 W		50	LB05F	8051
RG 80 G (D) (NC11A)		80	LB05F	8051
RG 80 Gamma		80	LB05F	8051
RG 80 WF		80	LB05F	8051
RM 125	- 86	125	LB05F/CR2	8051/8048
RM 125	96 -	125	LB05F/CR2	8051/8048
RM 125	87 - 92	125	LB05F/CR2	8051/8048
RM 125	93 - 95	125	LB05F/CR2	8051/8048
RM 50	- 89	50	LB05F	8051
RM 50	90 -	50	LB05F	8051
RM 80	93 -	80	LB05F	8051
RM 80 H		80	LB05F	8051
RM 80 X	91 -	80	LB05F	8051
RM 80 X	- 90	80	LB05F	8051
RV 50		50	LB05F	8051
RV 90		90	LB05F	8051
RC 125		125	LB05F	8051
Suzy	95 -	50	LB05F	8051
TR 50		50	LB05F	8051
TR 50 S Magic	98 -	50	LB05F	8051
TS 100 X	78 -	100	LB05F	8051
TS 100 X	- 77	100	LB05F	8051
TS 125	01.75 - 12.85	125	LB05F	8051
TS 125 R		125	LB05F/CR2	8051/8048
TS 125 RC,C2,ER	- 86	125	LB05F	8051
TS 125 X		125	LB05F	8051
TS 185 ER	93 -	185	LB05F	8051
TS 200		200	LB05F/CR2	8051/8048
TS 50 12,7mm		50	LB05F	8051
TS 50 19,0mm		50	LB05F	8051
TS 50 ER		50	LB05F	8051
TS 50 XK (SA11C)		50	LB05F	8051
TS 80 ERX		80	LB05F	8051
TS 80 X (SA11A)		80	LB05F	8051
TS 80 XE-H		80	LB05F	8051
VS 750 GL/H/J-K		750	SD05F	8022
ZR 50		50	LB05F	8051

Order-
No.

				YAMAHA
Active 80	90 -	80	LB05F	8051
AG 100		100	LB05F	8051
AG 100 H / E / F		100	LB05F	8051
AG 175		175	LB05F	8051
AG 175 H		175	LB05F	8051
AG 200 E / F	93 -	200	LD05F/CR2	8060/8048
BL 125 (50W)	85 - 89	125	LB05F	8051
BW 200		200	LD05F	8060
BW 350		350	LD05F	8060
CA 50 (14T)	83 - 87	50	LB05F	8051
CE 50 E		50	LB05F	8051
CH 50		50	LB05F	8051
CH 80		80	LB05F	8051
CR 50 Z/SS	93 -	50	LB05F	8051
CV 50		50	LB05F	8051
CV 80		80	LB05F	8051
CW 50	91 - 93	50	LB05F	8051
CW 50 (4BX)	94 -	50	LB05F	8051
CW 65	94 -	65	LB05F	8051
CY 50	94 -	50	LB05F	8051
CY 50 E	93 -	50	LB05F	8051
CY 50 F	94 -	50	LB05F	8051
DT 100		100	LB05F	8051
DT 100 B		100	LB05F	8051
DT 100 C		100	LB05F	8051
DT 100 D		100	LB05F	8051
DT 100 E		100	LB05F	8051
DT 100 H		100	LB05F	8051
DT 100 SD		100	LB05F	8051
DT 100 X		100	LB05F	8051
DT 125	94 -	125	LB05F	8051
DT 125 E (1G0)	77 - 79	125	LB05F	8051
DT 125 E (AT2)	73 - 76	125	LB05F	8051
DT 125 ED		125	LB05F	8051
DT 125 F		125	LB05F	8051
DT 125 H		125	LB05F	8051
DT 125 LC	86 -	125	LB05F	8051
DT 125 LC (10V)	82 - 85	125	LB05F	8051
DT 125 MX		125	LB05F	8051
DT 125 R (4BL) / RE (3RM)	91 -	125	LB05F/CR2	8051/8048
DT 125 Tenere (I)		125	LB05F	8051
DT 165 R	91 -	165	LB05F	8051
DT 175 (CT1)	74 - 75	175	LB05F	8051
DT 175 E / F		175	LB05F	8051
DT 175 H		175	LB05F	8051
DT 175 MX (2K4)	09.78 - 12.81	175	LB05F	8051
DT 200 LC / RE / RF	93 -	200	LB05F	8051
DT 200 R		200	LB05F/CR2	8051/8048
DT 250 (512)	75 - 76	250	LB05F	8051
DT 250 E		250	LB05F	8051
DT 250 H		250	LB05F	8051
DT 250 MX (1R7)	77 - 81	250	LB05F	8051

Order-
No.

YAMAHA				
DT 360 (RT2)	01.73 - 12.75	360	LB05F	8051
DT 400 (513)	11.75 - 12.76	400	LB05F	8051
DT 400 E		400	LB05F	8051
DT 400 H		400	LB05F	8051
DT 400 MX (1R6)	77 - 80	400	LB05F	8051
DT 50		50	LB05F	8051
DT 50 A (F)		50	LB05F	8051
DT 50 E	93 -	50	LB05F	8051
DT 50 F	94 -	50	LB05F	8051
DT 50 M (S)	86 -	50	LB05F	8051
DT 50 M (NL)	86 -	50	LB05F	8051
DT 50 M (D)	86 -	50	LB05F	8051
DT 50 M (A) (B)	86 -	50	LB05F	8051
DT 50 M (2M4)	78 - 81	50	LB05F	8051
DT 50 MX (1NN)	01.86 - 12.89	50	LB05F	8051
DT 50 R (3MN2)(3MN3)(3HL3)(4CT2)(4CT4)(4CT6)	91 -	50	LB05F	8051
DT 80 LC-I (37A)	83 - 86	80	LB05F	8051
DT 80 LC-II (53V)	84 -	80	LB05F	8051
DT 80 MX (5J1)	81 - 84	80	LB05F	8051
DT 80 MX-S (5T8)	83 - 86	80	LB05F	8051
DX 100		100	LB05F	8051
DX 100 H		100	LB05F	8051
ES 50		50	LB05F	8051
Fizz (4RC)	95 -	50	LB05F	8051
FJ 1100 (47E)	84 - 85	1100	SD05F	8022
FJ 1200 (1XJ)	86 - 87	1200	SD05F	8022
FJ 1200 (3CW)	88 - 90	1200	SD05F	8022
FJ 1200 (3YA)	91 -	1200	SD05F	8022
FJ 1200 AE/ AEC / E / F	93 -	1200	SD05F	8022
FS 1 DX (3F2)	79 - 80	50	LB05F	8051
FS 1 E		50	LB05F	8051
FS 3 M		50	LB05F	8051
FS 80		80	LB05F	8051
FS 80 SE (5A7)	81 - 82	80	LB05F	8051
FZ 150	94 -	150	LD05F	8060
FZ 750 (1FN)	85 - 86	750	SD05F/CR1	8022/8035
FZ 750 (3KT)	91 -	750	SD05F/CR1	8022/8035
FZ 750 Genesis (2KK)	87 - 90	750	SD05F/CR1	8022/8035
FZR 150	94 -	150	LD05F	8060
FZR 400	04.87 -	400	SD05F/CR1	8022/8035
Golf Car G2A/G9A	92 -		LB05F	8051
GT 50 B		50	LB05F	8051
GT 50 D (FT1)	73 - 75	50	LB05F	8051
GT 80 (477)	74 - 75	80	LB05F	8051
GT 80 D		80	LB05F	8051
GT 80 E		80	LB05F	8051
IT 125		125	LB05F	8051
IT 125 H		125	LB05F	8051
IT 175 (5Y0)	83 - 84	175	LB05F	8051
IT 175 E		175	LB05F	8051
IT 175 H		175	LB05F	8051
IT 200 S		200	LB05F	8051

Order-
No.

				YAMAHA
IT 250 (45J)	85 -	250	LB05F	8051
IT 250 (4V5)	81 -	250	LB05F	8051
IT 250 J		250	LB05F	8051
IT 250 K		250	LB05F	8051
IT 250 N		250	LB05F	8051
IT 400		400	LB05F	8051
IT 400 E		400	LB05F	8051
IT 425		425	LB05E	8031
IT 465 (4V6)	81 -	465	LB05E	8031
IT 465 H		465	LB05E	8031
IT 490 (29W)	83 - 85	490	LB05F	8051
IT 500		500	LB05F	8051
Jog 50	90 -	50	LB05F	8051
LB 2		50	LB05F	8051
LB 2 80	- 80	50	LB05F	8051
LB 2 80	81 -	50	LB05F	8051
LB 2 M	81 -	50	LB05F	8051
LB 2 M (551)	75 - 80	50	LB05F	8051
LB 3 80		50	LB05F	8051
LB 3 M		50	LB05F	8051
LB 80		80	LB05F	8051
LB 80 2A		80	LB05F	8051
LB 80 2AC		80	LB05F	8051
LB 80 2AD		80	LB05F	8051
LB 80 2H		80	LB05F	8051
LB 80 2HD		80	LB05F	8051
LB 80 3 (1M9)	78 - 79	80	LB05F	8051
LB 80 3D		80	LB05F	8051
LC 50		50	LB05F	8051
LC 50 H		50	LB05F	8051
LC 50 M		50	LB05F	8051
MA 50		50	LB05F	8051
MA 50 M		50	LB05F	8051
MBK Magnum	90 -	50	LB05F	8051
YFM 200 (MOTO4 ATV)	92 -	200	LD05F	8060
YFM 225 59V/2HT (MOTO4 ATV)	92 -	225	LD05F	8060
MR 50		50	LB05F	8051
MR 50 H		50	LB05F	8051
MX 100	79 -	100	LB05F	8051
MX 100 B		100	LB05F	8051
MX 100 H		100	LB05F	8051
MX 125		125	LB05F	8051
MX 175		175	LB05F	8051
MX 175 B		175	LB05F	8051
MX 175 H		175	LB05F	8051
MX 250		250	LB05F	8051
MX 360		360	LB05F	8051
MX 400		400	LB05F	8051
MX 80		80	LB05F	8051
MX 80 H		80	LB05F	8051
NR 200		200	LB05F	8051
PW 50 (3PT)	01.87 -	50	LB05F	8051

Order-
No.

YAMAHA			
PW 50 E	93 -	50	LB05F 8051
PW 50 H / F		50	LB05F 8051
PW 80 (21W)	83 - 90	80	LB05F 8051
PW 80 E / F (4BC)	93 -	80	LB05F 8051
QT 50		50	LB05F 8051
QT 50 H		50	LB05F 8051
R 125 SE		125	LB05F 8051
R1-Z	93 -	250	L05F/CR2 .../8048
RD 125 12,7mm		125	LB05F 8051
RD 125 19,0mm		125	LB05F 8051
RD 125 C		125	LB05F 8051
RD 125 C-DX		125	LB05F 8051
RD 125 D		125	LB05F 8051
RD 125 D-DX (AS3)	73 - 75	125	LB05F 8051
RD 125 LC	84 -	125	LB05F 8051
RD 125 LC (10W)	82 - 83	125	LB05F 8051
RD 200 12,7mm		200	LB05F 8051
RD 200 19,0mm (397)		200	LB05F 8051
RD 200 C		200	LB05F 8051
RD 200 C-DX		200	LB05F 8051
RD 200 D		200	LB05F 8051
RD 200 D-DX (1E8)	77 - 80	200	LB05F 8051
RD 250 (522)	75 -	250	LB05F 8051
RD 250 D		250	LB05F 8051
RD 250 LC (4L1)	80 - 83	250	LB05F 8051
RD 400 (1A3)	76 - 79	400	LB05F 8051
RD 400 E		400	LB05F 8051
RD 50 DX (353)	73 - 75	50	LB05F 8051
RD 50 H		50	LB05F 8051
RD 50 MX (2E0)	77 - 81	50	LB05F 8051
RD 500 LC (1GE)	85 - 86	500	LB05F 8051
RD 500 LC (47X)	- 84	500	LB05F 8051
RD 60 B		60	LB05F 8051
RD 80 LC-II (30W)	83 - 87	80	LB05F 8051
RD 80 MX (5G1)	81 - 82	80	LB05F 8051
RS 100 B		100	LB05F 8051
RS 100 DX (1Y8)	76 - 81	100	LB05F 8051
RS 100 P		100	LB05F 8051
RS 100 S		100	LB05F 8051
RS 100 X		100	LB05F 8051
RS 125 DX		125	LB05F 8051
RS 125 E		125	LB05F 8051
RS 125 P		125	LB05F 8051
RS 125 Z		125	LB05F 8051
RS 195		195	LB05F 8051
RS 200		200	LB05F 8051
RT 100 E / F	93 -	100	LB05F 8051
RT 180 E	93 -	180	LB05F 8051
RX 100 12,7mm		100	LB05F 8051
RX 100 19,0mm		100	LB05F 8051
RX 115	93 -	115	LB05F 8051
RX 125 12,7mm		125	LB05F 8051

Order-
No.

				YAMAHA	
RX 125 19,0mm			125	LB05F	8051
RX 125 H			125	LB05F	8051
RX 150		93 -	150	LB05F	8051
RX 80 SE (12N)		82 - 83	80	LB05F	8051
RXS 100			100	LB05F	8051
RX-ZD		93 -	100	LB05F	8051
SA 50			50	LB05F	8051
SA 50 H			50	LB05F	8051
SA 50 M			50	LB05F	8051
SE 250 (I)			250	LB05F	8051
SG 50 (34N)		84 - 85	50	LB05F	8051
SH 185 H			185	LD05F	8060
SH 50 / F			50	LB05F	8051
SH 50 E / ED / MF		93 -	50	LB05F	8051
SR 125			125	LD05F	8060
SR 125 (10F)		97 -	125	LD05F	8060
SR 125 Z		93 -	125	LD05F	8060
SR 150		93 -	150	LD05F	8060
SR 250 (I)			250	LB05F	8051
SR 250 H / F			250	LB05F	8051
SR 250 SE (3Y8)		80 - 82	250	LB05F	8051
SR 250 TH			250	LB05F	8051
SR 400			400	LB05F/CR2	8051/8048
SR 500 (3EB)		95 -	500	LB05F/CR2	8051/8048
SR 500 (2J4,48T)		01.79 - 96	500	LB05F/CR2	8051/8048
SR 500 (48T)		97 -	500	LB05F/CR2	8051/8048
SR 500 E			500	LB05F/CR2	8051/8048
SR 500 H			500	LB05F/CR2	8051/8048
SRX 600 (1XM,1XN)		86 - 89	600	SD05F/CR1	8022/8035
T 50			50	LD05F	8060
T 80			80	LD05F	8060
TA 125 (400)		73 - 75	125	LB05F	8051
TA 125 A			125	LB05F	8051
TDR 125 (4GW)		92 -	125	LB05F	8051
TDR 125 (5AN)		97 -	125	LB05F	8051
TDR 240			240	LB05F	8051
TDR 250 (3CK)		88 - 89	250	LB05F	8051
TRD 250 (I)			250	LB05F	8051
TT 225 (MOTO4 ATV)			225	LD05F	8060
TT 250			250	LB05F	8051
TT 250 R / RF		94 -	250	LB05F/CR2	8051/8048
TT 400 C			400	LB05F	8051
TW 200		01.87 -	200	LD05F	8060
TW 200 E / EC / F		93 -	200	LD05F	8060
TW 200 FC		94 -	200	LD05F	8060
TY 125 (1K6)		77 - 81	125	LB05F	8051
TY 175			175	LB05F	8051
TY 175 E			175	LB05F	8051
TY 175 J			175	LB05F	8051
TY 250 (38V)		84 - 87	250	LB05F	8051
TY 250 (3BA)		88 - 90	250	LB05F	8051
TY 250 (S16)		75 - 79	250	LB05F	8051

Order-
No.

YAMAHA				
TY 250 Z (4GG)	94 - 96	250	LB05F	8051
TY 50 M (1G3)	77 - 80	50	LB05F	8051
TY 80		80	LB05F	8051
TZ 125 (4JT)	95 -	125	LB05F	8051
TZ 125 (3V3)	80 -	125	LB05F	8051
TZ 125 / F	94 -	125	LB05F	8051
TZ 125 H		125	LB05F	8051
TZ 250	- 83	250	LB05F	8051
TZ 250	84 -	250	LB05F	8051
TZ 250 (ADP)	95 -	250	LB05F	8051
TZ 250 / F	94 -	250	LB05F	8051
TZ 250 E	- 83	250	LB05F	8051
TZ 250 E/E1	93 -	250	LB05F	8051
TZ 250 H	- 83	250	LB05F	8051
TZ 350 B		350	LB05F	8051
TZ 350 H		350	LB05F	8051
TZ 750		750	LB05F	8051
TZ 750 D		750	LB05F	8051
TZR 125	93 -	125	LB05E	8031
TZR 125	- 92	125	LB05F/CR2	8051/8048
TZR 250 " V2"	91 - 95	250	LB05E	8051
TZR 250 (2MA)	87 - 89	250	LB05F	8051
TZR 250R/RS/RSP	93 -	250	LB05E	8051
V 100/E/S/SH	93 -	100	LB05F	8051
V 110 E	93 -	110	LB05F	8051
V 120 JR / ZR	94 -	120	LB05F	8051
V 50		50	LB05F	8051
V 50 D	93 -	50	LB05F	8051
V 50 E		50	LB05F	8051
V 50 M	- 80	50	LB05F	8051
V 50 M	81 - 83	50	LB05F	8051
V 50 M	84 -	50	LB05F	8051
V 80		80	LB05F	8051
V 80 H / D		80	LB05F	8051
WR 200 R / RE / RF	93 -	200	LB05F	8051
WR 250 Z / ZE / ZF (4JW)	93 -	250	LB05E	8031
XC 180 (32H)	83 - 84	180	LD05F	8060
XJ 400		400	XD05F	8072
XJ 500		500	XD05F	8072
XJ 650 (4K0)	80 - 83	650	XB05F	8062
XJ 650 H		650	XB05F	8062
XJ 650 LH		650	XB05F	8062
XJ 650 SH		650	XB05F	8062
XJ 650 T (Turbo) (11T)	82 -	650	XB05F	8062
XJ 750	- 83	750	LB05F/CR2	8051/8048
XJ 750 (41Y)	84 - 85	750	LB05F/CR2	8051/8048
XJ 750 RH		750	LB05F/CR2	8051/8048
XJ 900 (31A)	83 - 84	900	XB05F	8062
XJ 900 (4BB)	91 -	900	XB05F	8062
XJ 900 (58L)	85 - 90	900	XB05F	8062
XS 1100 (2H9)	78 - 82	1100	XB05F	8062
XS 1100 E		1100	XB05F	8062

Order-
No.

				YAMAHA
XS 1100 H			1100	XB05F 8062
XS 1100 LH			1100	XB05F 8062
XS 1100 RH			1100	XB05F 8062
XS 1100 S (5K7)	81 -	82	1100	XB05F 8062
XS 1100 SH			1100	XB05F 8062
XS 250 (1V5)	78 -	79	250	LB05F 8051
XS 250 C			250	LB05F 8051
XS 250 H			250	LB05F 8051
XS 250 RH	-	83	250	LB05F 8051
XS 250 SE			250	SD05F/CR1 8022/8035
XS 250 SH			250	SD05F/CRI 8022/8035
XS 650 (447)	76 -	83	650	XB05F 8062
XS 650 (I)			650	XB05F 8062
XS 650 E			650	XB05F 8062
XS 650 H			650	XB05F 8062
XS 650 II			650	XB05F 8062
XS 650 S			650	XB05F 8062
XS 650 SE (3L1)	79 -	81	650	XB05F 8062
XS 650 SH			650	XB05F 8062
XS 750 (1T5)	77 -	79	750	XB05F 8062
XS 750 C			750	XB05F 8062
XS 750 D			750	XB05F 8062
XS 750 E			750	XB05F 8062
XS 750 S			750	XB05F 8062
XS 750 SE			750	XB05F 8062
XS 750 T			750	XB05F 8062
XS 850 (4E2)	80 -	81	850	XB05F 8062
XS 850 H			850	XB05F 8062
XS 850 LH			850	XB05F 8062
XS 850 SH			850	XB05F 8062
XT 125			125	LD05F 8060
XT 225 E / EC / F / FC	93 -		225	LD05F 8060
XT 250 (3Y3)	80 -	82	250	SD05F 8022
XT 250 H	-	84	250	LB05F 8051
XT 350 (3YT)	91 -		350	LD05F 8060
XT 350 (55V)	85 -	90	350	LD05F 8060
XT 350 E / F	93 -		350	LD05F 8060
XT 400	84 -		400	LD05F 8060
XT 500 (1E6,1V6)	76 -	89	500	LB05F 8051
XT 500 C			500	LB05F 8051
XT 500 E	-	92	500	LB05F 8051
XT 500 H			500	LB05F 8051
XT 550 (5Y3)	82 -	83	550	LD05F 8060
XT 600 (2KF,2NF)	87 -	90	600	XD05F 8072
XT 600 (43F)	84 -	87	600	XD05F 8072
XT 600 E (4PT / 4SK)	95 -		600	LD05F 8060
XT 600 E / EF / EFC	94 -		600	LD05F 8060
XT 600 E(h) (3TB)	97 -		600	LD05F 8060
XT 600 E(n) (3UW)	97 -		600	LD05F 8060
XT 600 E/K (3TB/3UW)	90 -	94	600	LD05F 8060
XTS 750 SE			750	XB05F 8062
XV 1100 (3LP)	95 -		1100	XB05F 8062

Order-
No.

YAMAHA				
XV 1100 SC		1100	XB05F	8062
XV 125 (5AJ)		97 - 125	LD05F	8060
XV 240		240	LD05F	8060
XV 250		94 - 250	LD05F	8060
XV 250 (3LS,3LW)		89 - 250	LD05F	8060
XV 250 F		94 - 250	LD05F	8060
XV 250 S (3LW)		95 - 250	LD05F	8060
XV 400 SE		400	XB05F	8062
XV 500 (I)		500	XB05F	8062
XV 500 SE (26R)		83 - 87	500 XB05F	8062
XV 750		- 83	750 XB05F	8062
XV 750 (4PW)		95 - 750	XB05F	8062
XVZ 12T (47G)		84 - 87	1200 XD05F	8072
XZ 550 (11V)		82 - 84	550 LD05F	8060
XZ 550 S (11V)		83 - 84	550 LD05F	8060
Y 80			80 LB05F	8051
Y 80 E			80 LB05F	8051
YA 50 (5AK)		97 - 50	LB05F	8051
YA 90 E / F		93 - 90	LB05F	8051
YB 100		94 - 100	LB05F	8051
YB 100 M			100 LB05F	8051
YB 100 P			100 LB05F	8051
YB 125			125 LB05F/CR2	8051/8048
YB 50 S			50 LB05F	8051
YB 60			60 LB05F	8051
YB 80			80 LB05F	8051
YE 50		93 - 50	LB05F	8051
YE 80 (4MU)		94 - 80	LB05F	8051
YF 60 (1HN) (MOTO4 ATV)		87 - 88	60 LB05F	8051
YFA 1 Breeze (MOTO4 ATV)		89 - 04	125 LD05F	8060
YFA 1 F (MOTO4 ATV)		94 - 125	LD05F	8060
YFB 250 / E / F / FWF (MOTO4 ATV)		93 - 250	LD05F	8060
YFB 250 / FW (MOTO4 ATV)		94 - 250	LD05F	8060
YFM 80 (MOTO4 ATV)			80 LD05F	8060
YFM 80 W Badger (ATV)		02 - 80	LD05F	8060
YFM 80 W Raptor (ATV)		02 - 80	LD05F	8060
YFM 80 E / F (MOTO4 ATV)		93 - 80	LD05F	8060
YFM 200 (52H) (MOTO4 ATV)		85 - 86	200 LD05F	8060
YFM 225 (2HT) (MOTO4 ATV)			200 LD05F	8060
YFM 225 (59V) (MOTO4 ATV)			200 LD05F	8060
YFM 250 Timberwolf (MOTO4 ATV)			250 LD05F	8060
YFM 250 (3GH) (MOTO4 ATV)		90 - 250	LD05F	8060
YFS 200 Blaster (MOTO4 ATV)		90 - 04	200 LB05F	8051
YFS 200 E / F (MOTO4 ATV)		93 - 200	LB05F	8051
YS 125			125 LB05F	8051
YT 125 (MOTO4 ATV)			125 LB05F	8051
YT 125 CH (MOTO4 ATV)			125 LB05F	8051
YT 125 H (MOTO4 ATV)			125 LB05F	8051
YT 175 (MOTO4 ATV)			175 LB05F	8051
YZ 100		- 83	100 LB05F	8051
YZ 100 E			100 LB05F	8051
YZ 100 H			100 LB05F	8051

Order-
No.

APRILIA				
Scarabeo De Luxe	98- 03	50	LB05F	8051
Scarabeo 50	93- 03	50	LB05F	8051
CCF				
Cat 50	97-	50	LB05FP	8030
DAELIM				
VC 125	97-	125	XB01F	8431
VS 125	97-	125	XB01F	8431
HONDA				
CH 125	01.86- 95	125	LD05F	8060
CH 125 P	-01.93	125	LD05F	8060
CN 250	01.86-	250	VD05F	8052
CN 250 Fusion		250	VD05F	8052
CN 250 Helix (MF02)	01.87- 99	250	VD05F	8052
Joker SRX50T	97-	50	LB05F	8051
NB 50		50	LB05F	8051
NB 50 M Melody (AB07)	84-	50	LB05F	8051
NH 125 D Lead	83-	125	LB05F	8051
NH 50 M	93-	50	LB05F	8051
NH 50 MS Lead (AF01)	85- 87	50	LB05F	8051
NH 80 MS Lead (HD01)	83-	80	LB05F	8051
PK 50 Wallaro	90-	50	LB05F	8051
PX 50	89- 90	50	LB05F	8051
SA 50 Vision	01.88- 90	50	LB05F	8051
SFX 50	95-	50	LB05F	8051
SGX 50 Sky	97-	50	LB05F	8051
SH 100 T	01.96-	100	LB05F	8051
SH 50 P	01.93- 95	50	LB05F	8051
SH 50 T	96-	50	LB05F	8051
SH 50 (I)	01.87- 96	50	LB05F	8051
SH 50 (AF40)	97-	50	LB05F	8051
SJ 100 Bali	01.96-	100	LB05F	8051
SJ 50 Bali		50	LB05F	8051
Spacy CH 125 (JS03)	97-	125	LD05F	8060
ITALJET				
Dragster 50	98-	50	LB10F	31125
Dragster 50	97- 98	50	LB10F	31125
Dragster 50	96- 97	50	LB10F	31125
Dragster 125	97- 97	125	LB05F	8051
Fastboy	98-	50	LB05F	8051
Formula 50 aircool	98-	50	LB05F	8051
Formula 50 watercool	98-	50	LB05F	8051
Formula 125	97- 98	125	LB05F	8051
Formula 125	98-	125	LB05F	8051
Torpedo 25	97-	50	LB10F	31125
KTM				
Chrono 50		50	LB05F	8051
Go 50		50	LB05F	8051

Order-
No.

				KTM	
K 50 (I)		50	LB05F		8051
				KYMCO	
Calypso 125	97-	125	VD05F		8052
Calypso 50	97-	50	VD05F		8052
				K-ZWO	
Cat 50	97-	50	LB05FP		8030
				PEUGEOT	
Speedfight LC	96-	50	LB05E		8031
Speedfight M	96-	50	LB05E		8031
Speedfight 100	96- 03	100	LB05E		8031
SV 100	96-	100	LB05E		8031
SV 50	96-	50	LB05E		8031
Trekker Off Road	98-	50	LB05E		8031
Trekker Road		50	LB05E		8031
Trekker 100	98-	100	LB05E		8031
				PGO	
Big Max 25/50		50	LB05F		8051
Big Max 50		50	LB05F		8051
Big Max 90	96-	82	LB05F		8051
Big Max Sport 50	96-	50	LB05F		8051
Comet		50	LB05F		8051
Galaxy 25		50	LB05F		8051
Galaxy 50		50	LB05F		8051
Mega 50	96-	50	LB05F		8051
PMS 50	99-	50	LB05F		8051
PMX 50	99-	50	LB05F		8051
Rodoshow	02.00-	50	LB05F		8051
Star 2		50	LB05F		8051
Star 50		50	LB05F		8051
Star 80		80	LB05F		8051
Tornado 50	97-	50	LB05F		8051
T-REX 125 2T	99-	125	LB05F		8051
T-REX 125 4T	99-	125	YB05F		8082
T-REX 50	99-	50	LB05F		8051
				PIAGGIO	
125 T5	03.85-	125	LB05F		8051
50 R, Special		50	LB05F		8051
50 S		50	LB05F		8051
Ape		125	LB05F		8051
Ape		190	LB05F		8051
Ape		220	LB05F		8051
Boss		50	LB05F		8051
Bravo PV		50	LB05F		8051
Bravo P		50	LB05F		8051
Bravo - Si / Moped		50	LB05F		8051
Ciao M Kat		50	LB05F		8051
Ciao Mix / Mix		50	LB05F		8051

Order-
No.**PIAGGIO**

Ciao V Kat		50	LB05F	8051
Ciao-Bravo SI / Mofa		50	LB05F	8051
Cosa 200 FL EBC 12PS		125	LB05F	8051
Cosa 125	- 91	125	LB05F	8051
Cosa FL 125	91-	125	LB05F	8051
Cosa 125 MA AE	01.88-	125	LB05F	8051
Cosa 200 Aluzyl.12PS	93- 97	200	LB05F	8051
Cosa 200 MA AE	01.88-	200	LB05F	8051
Cosa FL 200	91-	200	LB05F	8051
Cosa 2 200	01.88- 91	200	LB05F	8051
Eaglet		50	LB05F	8051
ET 3		125	LB05F	8051
ET 4 Automatic		125	LB05F	8051
EX 150 (Hexagon)	94-	150	LB05F	8051
Free 25 Mofa		25	LB05F	8051
Free 50	93-	50	LB05F	8051
Grillo / Mofa		50	LB05F	8051
Hexagon LX 125	94-	125	LB05F	8051
Vespa 175		175	LB05F	8051
Hexagon 150	01.94-	150	LB05F	8051
Hexagon GT 250 4Takt	98-	250	VD05F	8052
NRG Extreme		50	LB05F	8051
NRG Extreme Kat		50	LB05F	8051
NRG		50	LB05F	8051
NRG H_0 Kat		50	LB05F	8051
NRG mc2 DT,DD		50	LB05F	8051
NRG mc2 50	01.96-	50	LB05F	8051
P 125 ETS	01.83-12.85	125	LB05F	8051
PK 100 S	06.82-	100	LB05F	8051
PK Automatic		125	LB05F	8051
PK 125, E, S		125	LB05F	8051
PK 125 XL 2		125	LB05F	8051
PK 125 XL Automatic		125	LB05F	8051
PK 50 S	09.82-12.87	50	LB05F	8051
PK 50 S Auto		50	LB05F	8051
PK 50	09.82-12.87	50	LB05F	8051
PK 50 XL 2		50	LB05F	8051
PK 50 XL2 Auto		50	LB05F	8051
PK 50 SS		50	LB05F	8051
PK 80 S	09.82-12.85	80	LB05F	8051
Plurimatic		50	LB05F	8051
Primavera	01.76-12.83	125	LB05F	8051
PX 125 E Lusso	01.82-	125	LB05F	8051
PX 150 E Lusso	01.82-	150	LB05F	8051
PX 200 E Grand-Sport	01.84-	200	LB05F	8051
PX 200 E Lusso	01.84-	200	LB05F	8051
PX 50		50	LB05F	8051
PX 80 E Lusso		80	LB05F	8051
PX 80 E,P 80 X		80	LB05F	8051
Quarz 50 Automatic	06.92-	50	LB05F	8051
Sfera RST 4 Takt	95-	125	LB05F	8051
Sfera 125	01.95-	125	LB05F	8051

Order-
No.

				PIAGGIO
Sfera 50 Automatico	01.91-	50	LB05F	8051
Sfera 50 , FL, RL, RST		50	LB05F	8051
Sfera 80 Automatic		80	LB05F	8051
Skipper 125 LX	01.93-	125	LB05F	8051
Skipper 150	01.93-	150	LB05F	8051
SKR 125	08.93-	125	LB05F	8051
SKR 150	98-	150	LB05F	8051
Storm Automatic	94-	50	LB05F	8051
Super Bravo / Mofa		50	LB05F	8051
Super Bravo 2 Gang / Mofa		50	LB05F	8051
TPH	93-	50	LB05F	8051
TPH	95-	125	LB05F	8051
TPH Automatic	94-	80	LB05F	8051
Velofax / Mofa		50	LB05F	8051
Vespa PK 50 XL 2 ,Automatic		50	LB05F	8051
Vespa HP 4M		50	LB05F	8051
Vespa Elestart		50	LB05F	8051
Vespa Delta, Puch Condor		50	LB05F	8051
Vespa Vale Especial/Standard		50	LB05F	8051
Vespa PK 75XL/ Elestart		75	LB05F	8051
Vespa PK 75S/ Elestart/ Junior		75	LB05F	8051
Vespa T3Li/T3		125	LB05F	8051
Vespa XL 125 Plurimat/ Elestart		125	LB05F	8051
Vespa 125 CL/LS/NK Primavera		125	LB05F	8051
Vespa T5		125	LB05F	8051
Vespa 125 T5 Sport/ Elestart		125	LB05F	8051
Vespa ET4 125	01.96-	125	LB05F	8051
Vespa PK 125	85-	125	LB05F	8051
Vespa PX 125 MA AE	86-	125	LB05F	8051
Vespa Special ET3 Primavera		125	LB05F	8051
Vespa 125 FL2	01.90-	125	LB05F	8051
Vespa PX 125 Kat		125	LB05F	8051
Vespa 150 long 19,0 mm		150	LB05F	8051
Vespa PX 150 Kat		150	LB05F	8051
Vespa 150 long 12,7 mm		150	LB05F	8051
Vespa PX 150 MA AE	86-	150	LB05F	8051
Vespa 160/ GT		160	LB05F	8051
Vespa 200 TX/ Elestart		200	LB05F	8051
Vespa 200 DN/ DS/ E		200	LB05F	8051
Vespa PX 200E/ Iris/ Iris Elestart		200	LB05F	8051
Vespa PX 200 MA AE	86-	200	LB05F	8051
Vespa SS		180	LB05F	8051
Vespa PK 75S Primavera / T3 Prima.		75	LB05F	8051
Vespino		50	LB05F	8051
Vespino NX/ SC/ T/ TL/ TN/ TS		50	LB05F	8051
Vespino TX/ XE		50	LB05F	8051
Zip Base 50		50	LB05F	8051
Zip 50	01.92-	50	LB05F	8051
Zip 50 Fast Rider	01.93-	50	LB05F	8051
Zip 50 SP		50	LB05F	8051
Zip & Zip (Hybrid)	94-	50	LB05F	8051
Zip 25 Mofa		25	LB05F	8051

Order-
No.

PIAGGIO				
Zip Base 25 / Mofa		25	LB05F	8051
PUCH				
Lido		50	LB05F	8051
Lido 125		125	LB05F	8051
SACHS				
Speedfight 50 AC	97-	50	LB05F	8051
Speedfight 50 LC	97-	50	LB05F	8051
Speedfight 50 LC ADT	97-	50	LB05F	8051
SIAM				
Falkon 50	97-	50	LB05FP	8030
SUZUKI				
AH 100 (I)	- 93	100	LB05F	8051
AH 100 (CE12A)	95-	100	LB05F	8051
AH 50 Adress (CA1GA)	92-	50	LB05F	8051
AH 50 GP	95-	50	LB05F	8051
AJ 50 ZZ (I)	95-	50	LB05F	8051
AN 125 (CF42A)	95- 95	125	LD05F	8060
AN 125 (CF42A)	96-	125	LD05F	8060
AN 150 T (I)	01.96-	150	LD05F	8060
AP 50 S CA1JA)	95-	50	LB05F	8051
AP 50 T (I)	96-	50	LB05F	8051
CP 50 (I)	89- 92	50	LB05F	8051
YAMAHA				
Aerox	97-	50	LB05F	8051
Axis (YA50R) (3UG)	97-	50	LB05F	8051
Axis Mofa (5AK)(YA50R)	97-	50	LB05F	8051
BL 125 (50W)	85- 89	125	LB05F	8051
Breeze (4RC)(YM50)	95-	50	LB05F	8051
BW 50 Spy (CW50RSP;4VA)	96-	50	LB05F	8051
BW 50 (4BX)	91- 95	50	LB05F	8051
BW 50 (CW50)	96-	50	LB05F	8051
BW 50 Bump (CW50RSX)	96-	50	LB05F	8051
BW 50 NG (CW50RS;4VA)	96-	50	LB05F	8051
BW 50 R (4BX)	96-	50	LB05F	8051
CR 50 Z (I)		50	LB05F	8051
CT 50 S (I)		50	LB05F	8051
CT 50 SS (I)		50	LB05F	8051
CW 50 R (4BX)		50	LB05F	8051
Evolis (4MU)		80	LB05F	8051
Evolis (YE50)(4FW)		50	LB05F	8051
Forte (YA50R) (3UG)		50	LB05F	8051
Jog-Z 50 (I)	01.95-	50	LB05F	8051
Neo's	97-	50	LB05F	8051
Spy 50 (I)		50	LB05F	8051
XC 125 (3TE)	90-	125	LD05F	8060
XC 125 Cygnus	- 94	125	LD05F	8060
XC 125 Cygnus	01.95-	125	LD05F	8060

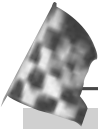

NGK Racing Cables



Bestell-Nr.	Kabel-Länge cm	Stecker-Typ
CR1	50	SD05FM
CR2	50	LZ05FM
CR3	50	SD05EMK
CR4	50	TB05EMA
CR5	100	LZ05FM
CR6	100	TB05EMA



CR1 + CR3



CR2 + CR4
CR5 + CR6





NGK Zündkerzenstecker mit Kabel



Bestell-Nr.	Kabel-Länge cm	Stecker-Typ
LY11	50	LZ05F 90° abgewinkelt
SY11	50	SZ05F gerade
XY11	50	XZ05F 102° abgewinkelt

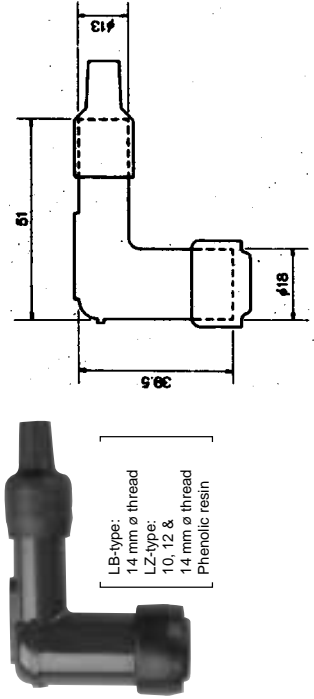

NGK SPARK PLUG RESISTOR COVER

Configuration (applicable plug thread dia, body material) Unit: mm	Type No.	 (k Ω)
  <div data-bbox="677 1085 789 1236" style="border: 1px solid black; padding: 5px; width: fit-content;"> LB-type: 14 mm ø thread LZ-type: 10, 12 & 14 mm ø thread Phenolic resin </div>	LBE LBEPK LBOE LBOEP LBOEPK LBOFF	No resistor No resistor 1,5,10 1,5 5 1,5,10
	LBOE	5,10

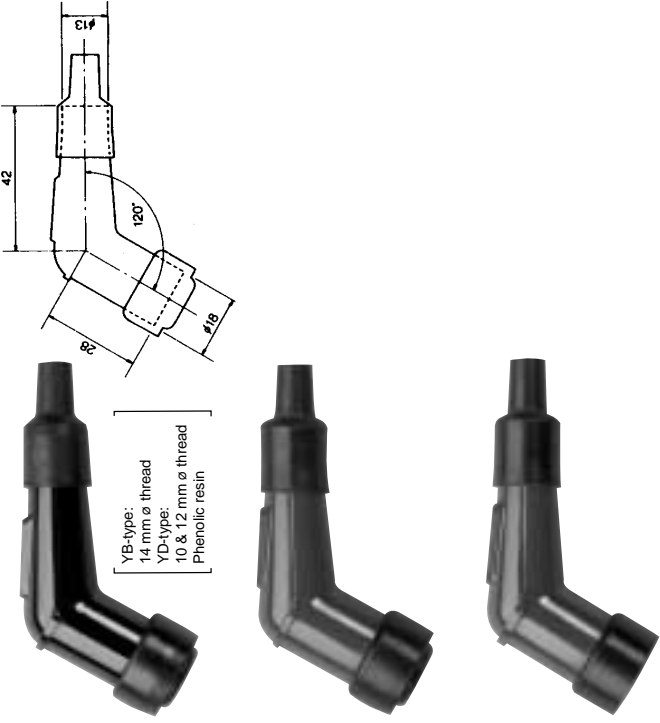



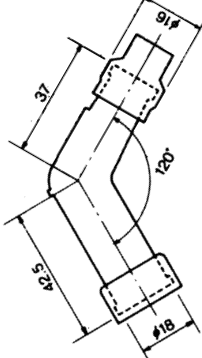

NGK SPARK PLUG RESISTOR COVER

Configuration (applicable plug thread dia, body material) Unit: mm	Type No.	 (K Ω)
 <p>YB-type: 14 mm ϕ thread YD-type: 10 & 12 mm ϕ thread Phenolic resin</p>	<p>YB\bigcircF YD\bigcircF</p> <p>YB\bigcircF</p> <p>YD\bigcircF</p>	<p>1,5,10 1,5</p> <p>5</p> <p>5</p>



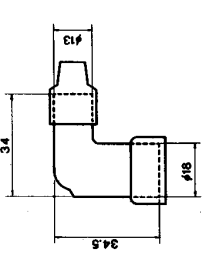

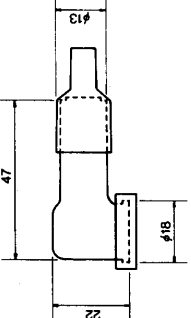
NGK SPARK PLUG RESISTOR COVER

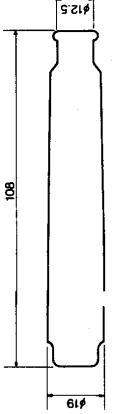
Configuration (applicable plug thread dia, body material) Unit: mm	Type No.	 (K Ω)
 <div data-bbox="767 1029 873 1165" style="border: 1px solid black; padding: 5px; width: fit-content;"> VB-type: 14 mm ϕ thread VD-type: 10 & 12 ϕ thread Phenolic resin </div> 	VB○E VB○F VB○FP VD○F VB○F VD○F	5,1 1,5,10 5 1,5,10 5 5



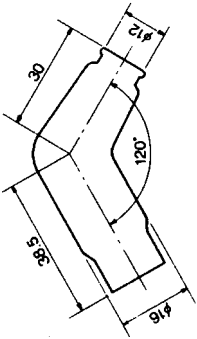

NGK SPARK PLUG RESISTOR COVER

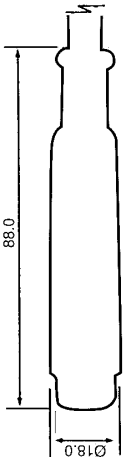
Configuration (applicable plug thread dia, body material) Unit: mm	Type No.	 (kΩ)
  [10, 12 & 14 mm ø thread Phenolic resin]	LZEH LZFH	No resistor No resistor
  [10 mm ø thread CM-6 only Phenolic resin]	LC0EFK	5
  [10 & 12 mm ø thread Rubber sheathed]	SD0FM	5



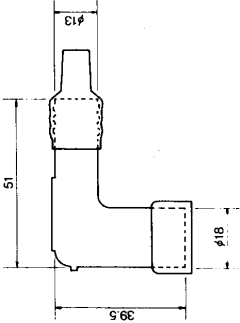

NGK SPARK PLUG RESISTOR COVER

Configuration (applicable plug thread dia, body material) Unit: mm	Type No.	 (KΩ)
  [10 & 12 mm ø thread Rubber sheathed]	VDO FMH	5
 	SD05FMC	5



NGK SPARK PLUG RESISTOR COVER

Configuration (applicable plug thread dia, body material) Unit: mm	Type No.	 (kΩ)
 	LDF LDOF	No resistor 1,5,10
 <p data-bbox="770 746 815 906"> [10 & 12 mm ø thread Phenolic resin] </p>	LDOF	5



NGK SPARK PLUG RESISTOR COVER

Configuration (applicable plug thread dia, body material) Unit: mm	Type No.	 (KΩ)
 [14 mm ø thread Rubber sheathed]	LBOEMH	5
 [14 mm ø thread Rubber sheathed (Silicon)]	TBOEM	5
 [10 & 12 mm ø thread Rubber sheathed (Silicon)]	VDOFML	5

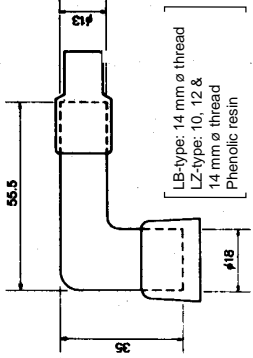

NGK SPARK PLUG RESISTOR COVER

Configuration (applicable plug thread dia, body material) Unit: mm	Type No.	 (kΩ)
 	LBF	No resistor
	LB○F	1,5,10
	LB○FP	1,5,10
	LB○EZ	5
	LB○F	5,10
	LZ○F	5

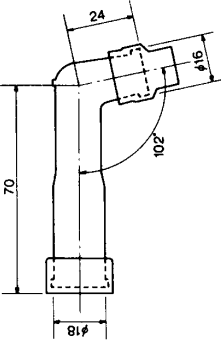

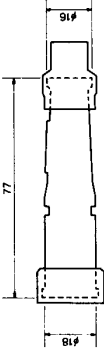

NGK SPARK PLUG RESISTOR COVER

Configuration (applicable plug thread dia, body material) Unit: mm	Type No.	
  <div style="border: 1px solid black; padding: 5px; width: fit-content; margin-left: 100px;"> <p> XB-type: 14 mm ϕ thread XD-type: 10 & 12 mm ϕ thread XZ-type: 10, 12 & 14 mm ϕ thread Phenolic resin </p> </div>	<p>XBOF</p> <p>XBOF XBOFP XDOF XZOF</p> <p>XDOF</p>	<p>5</p> <p>1,5,10 5 1,5,10 1</p> <p>1,5,</p>



NGK SPARK PLUG RESISTOR COVER

Configuration (applicable plug thread dia, body material) Unit: mm	Type No.	 (K Ω)
  <div style="border: 1px solid black; padding: 5px; width: fit-content; margin-left: auto; margin-right: auto;"> SB-type: 14 mm ϕ thread SD-type: 10 & 12 mm ϕ thread Phenolic resin </div>	SB ○ E SB ○ F SD ○ F	1,5,10 1,5,10 1,5,10
	SB ○ F	5,10
	SD ○ F	5



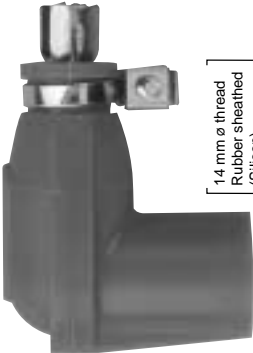
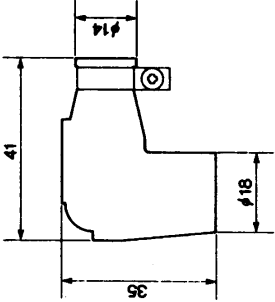

NGK SPARK PLUG RESISTOR COVER

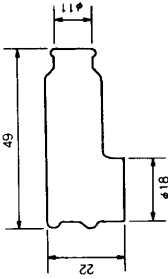
Configuration (applicable plug thread dia, body material) Unit: mm	Type No.	 (kΩ)
 <p data-bbox="348 911 445 1070"> LB-type: 14 mm ø thread LD-type: 10 & 12 mm ø thread Phenolic resin </p>	LEH LB ○EH LB ○EHF LDFH	No resistor 1,5,10 1,5 No resistor
 <p data-bbox="605 927 654 1070"> 14 mm ø thread Rubber sheathed </p>	TB ○EMA	5
 <p data-bbox="841 943 889 1070"> 14 mm ø thread Phenolic resin </p>	VB ○EYK	5



NGK SPARK PLUG RESISTOR COVER

Configuration (applicable plug thread dia, body material) Unit: mm	Type No.	 (KΩ) No resistor
 <p>[1.4 mm ø thread Rubber sheathed (Silicon)]</p> 	LBER	
 <p>(Blau)</p> <p>[1.4 mm ø thread Silicon – Rubber sheathed For spark plug R6120-○, R6120A-○, R6120C-○, R6120M-○ R7282-○, R7282A-○, R7282C-○, R7282M-○ ø 8 mm Kabel]</p> 	TRS1225	5

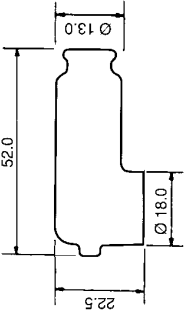

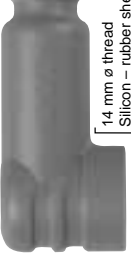

NGK SPARK PLUG RESISTOR COVER

Configuration (applicable plug thread dia, body material) Unit: mm	Type No.	 (K Ω)
<div style="display: flex; justify-content: space-around; align-items: center;"> <div style="text-align: center;">  (Gelb) </div> <div style="text-align: center;">  (Grün) </div> <div style="text-align: center;">  (Rot) </div> </div> <div style="text-align: center; margin-top: 20px;">  </div> <div style="border: 1px solid black; padding: 5px; margin-top: 10px; text-align: center;"> <p>14 mm ϕ thread Silicon – Rubber sheathed For spark plug R6120C-\circ, R6120A-\circ R6120C-\circ, R6120M-\circ R7282C-\circ, R7282A-\circ R7282C-\circ, R7282M-\circ ϕ 7 mm Kabel</p> </div>	TRS1233 A TRS1233 B TRS1233 C	5 5 5

NGK SPARK PLUG RESISTOR COVER

Configuration (applicable plug thread dia, body material) Unit: mm	Type No.	 (kΩ)
 <p>(Blau)</p> <p>14 mm ø thread Silicon – rubber sheathed For spark plug R5300A-○, R5300N-○ ø 8 mm Kabel</p>	<p>TRS1408F</p>	<p>5</p>
 <p>(Rot)</p> <p>14 mm ø thread Rubber sheathed Silicon For spark plug R5540F-○ ø 7 mm Kabel</p>	<p>TRS1409</p>	<p>5</p>
 <p>(Blau)</p> <p>14 mm ø thread Silicon – rubber sheathed For spark plug R6120-○, R6120A-○, R6120C-○, R6120M-○ R7282-○, R7282A-○, R7282C-○, R7282M-○ ø 7 mm Kabel</p>	<p>TRS1505</p>	<p>5</p>

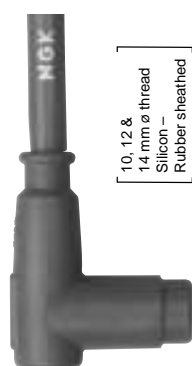
NGK SPARK PLUG RESISTOR COVER

Configuration (applicable plug thread dia, body material) Unit: mm	Type No.	
 <p>10, 12 & 14 mm ϕ thread Silicon - Rubber sheathed</p> <p>108(CR1), 115(CR3)</p> <p>$\phi 19$</p>	<p>CR1 CR3</p>	<p>5 5</p>
 <p>10, 12 & 14 mm ϕ thread Silicon - Rubber sheathed</p> <p>58(CR2, CR5) 49(CR4, CR6)</p> <p>49(CR2, CR5) 46(CR4, CR6)</p> <p>$\phi 9.5$</p>	<p>CR2 CR4 CR5 CR6</p>	<p>5 5 5 5</p>
<p>Kabelverbinder</p> 	<p>J-1</p>	

Erklärung der Kurzzeichen

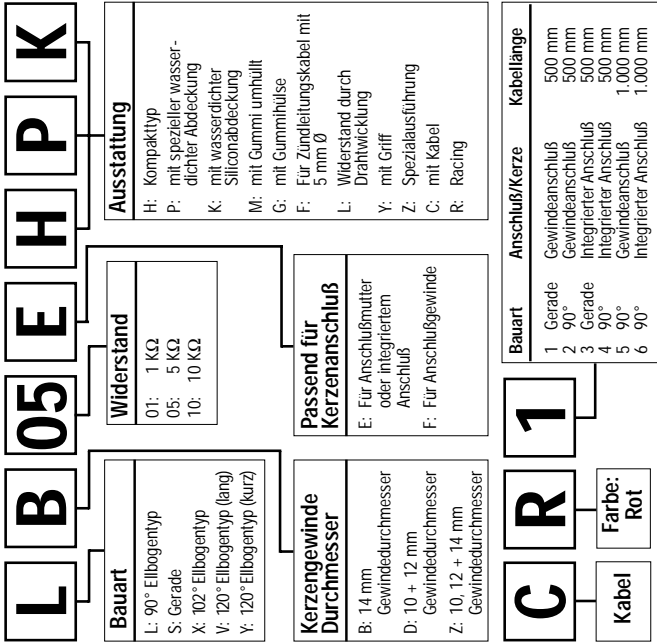

* TRS... Stecker nur für Rembetrieb

SYMBOL EXPLANATION

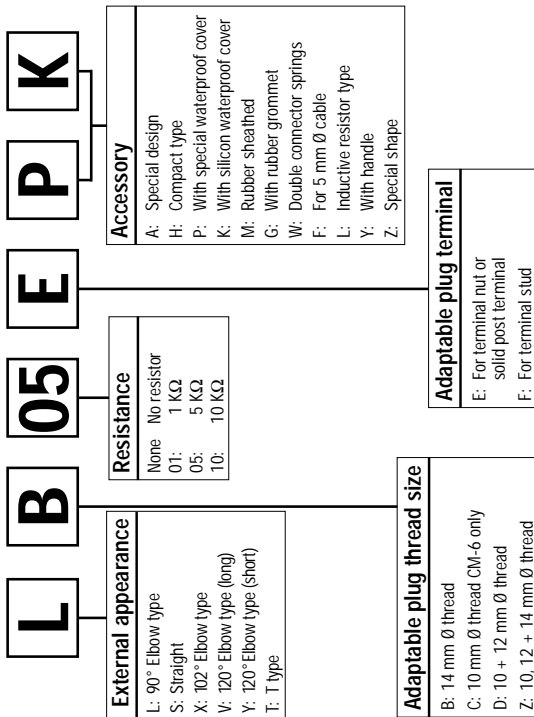

Markierungszeichen auf NGK Zündkerzen

Die Standard- Typenschrift ist hier aufgeführt. Es gibt außerdem noch einige besondere Bezeichnungen.

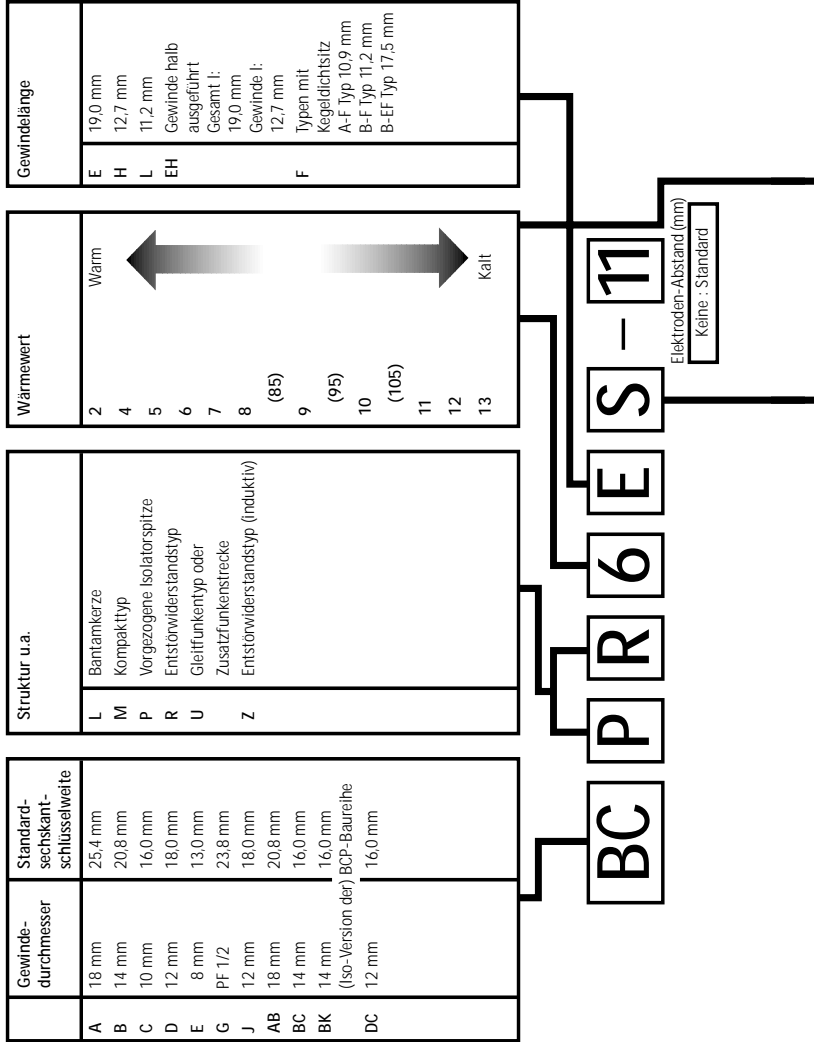

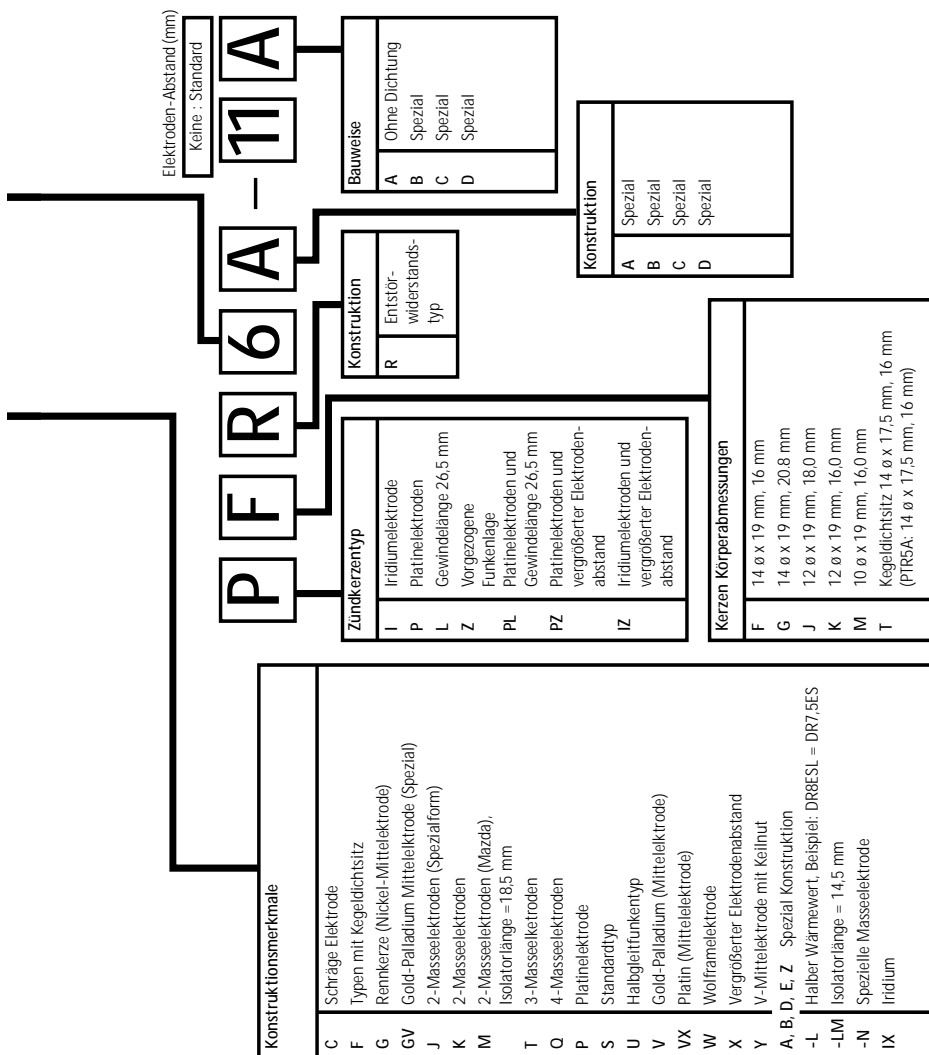

Design symbols used in NGK spark plugs

* Standard regulation is drawn here. There also exist a few extraordinary symbols.

	Thread Size	Hexagon Size	Construction Feature	Heat Rating Number	Thread Reach
A	18 mm	25,4 mm	L Compact type (Shorty)	2 Hotter	E 19,0 mm
B	14 mm	20,8 mm	M Compact type (Bantam)	4	H 12,7 mm
C	10 mm	16,0 mm	P Projected insulator type	5	L 11,2 mm
D	12 mm	18,0 mm	R Resistor type	6	EH Half thread
E	8 mm	13,0 mm	U Surface or semisurface discharge type	7	Total: 19,0 mm
G	PF 1/2	23,8 mm	Z Inductive resistor type	8	Thread: 12,7 mm
J	12 mm	18,0 mm		(85)	F
AB	18 mm	20,8 mm		9	Conical seat type
BC	14 mm	16,0 mm		(95)	A-F type 10,9 mm
BK	14 mm	16,0 mm		10	B-F type 11,2 mm
	(iso type of BCP)	16,0 mm		(105)	B-EF type 17,5 mm
DC	12 mm	16,0 mm		11	
				12	
				13 Colder	

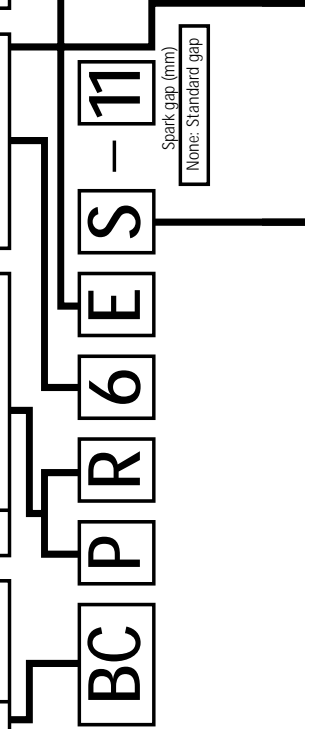

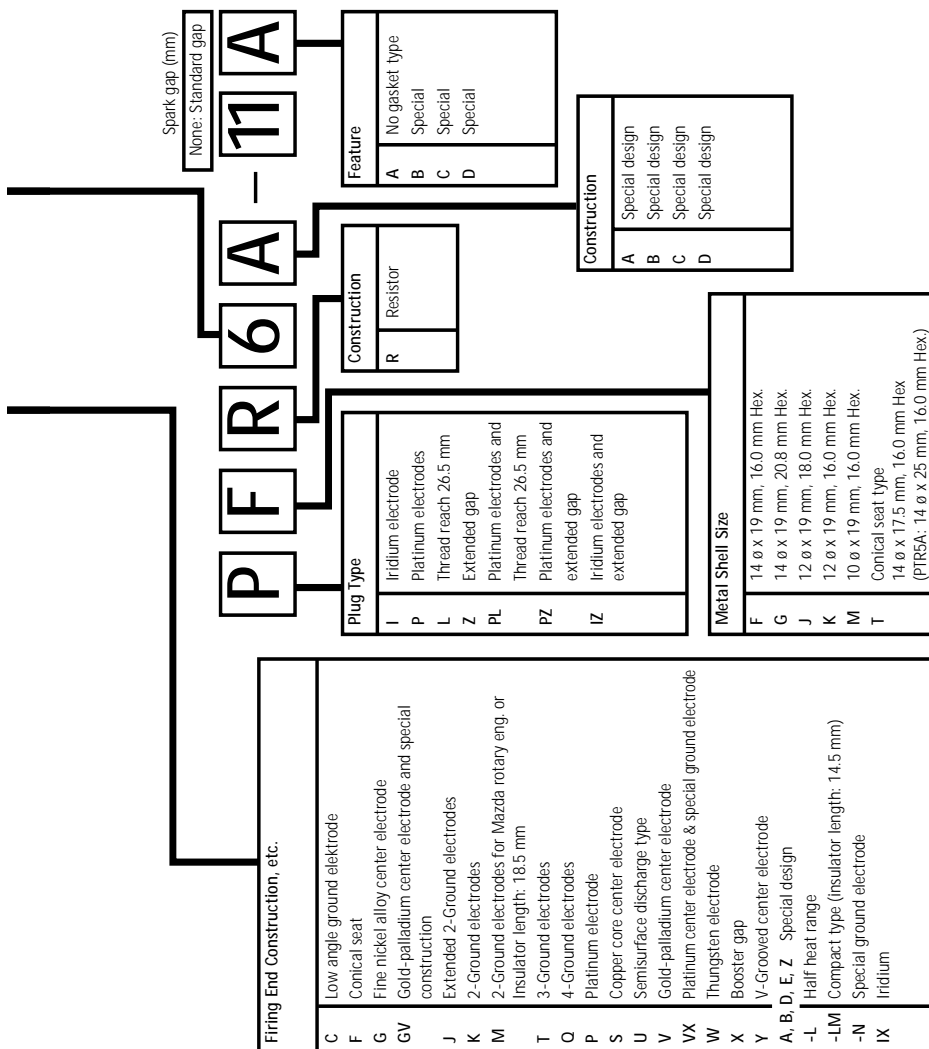

Symboles utilisés pour les Bougies d'Allumage NGK

* Les symboles standards sont expliqués ci-dessous. Il existe également quelques symboles exceptionnellement utilisés.

	Diamètre filotage	CILÉ	Dessin de la bougie	Indice thermique	Longueur de filetage
A	18 mm	25,4 mm	L Isolant court (shortly)	2 Chaud	E 19,0 mm
B	14 mm	20,8 mm	M Type compact (Bantam)	4	H 12,7 mm
C	10 mm	16,0 mm	P Isolant proéminent	5	L 11,2 mm
D	12 mm	18,0 mm	R Résistance intégrée	6	EH Semi-filetage
E	8 mm	13,0 mm	U Décharge superficielle ou semi- superficielle	7	Culot L = 19,0 mm
G	1/2 pouce	23,8 mm	Z Inductance intégrée	8	Filet L = 12,7 mm
J	12 mm	18,0 mm		(85)	siège conique
AB	18 mm	20,8 mm		9	A-F type 10,9 mm
BC	14 mm	16,0 mm		(95)	B-F type 11,2 mm
BK	14 mm	16,0 mm		10	B-EF type 17,5 mm
		(BCP aux normes ISO)		(105)	
DC	12 mm	16,0 mm		11	
				12	
				13 Froid	

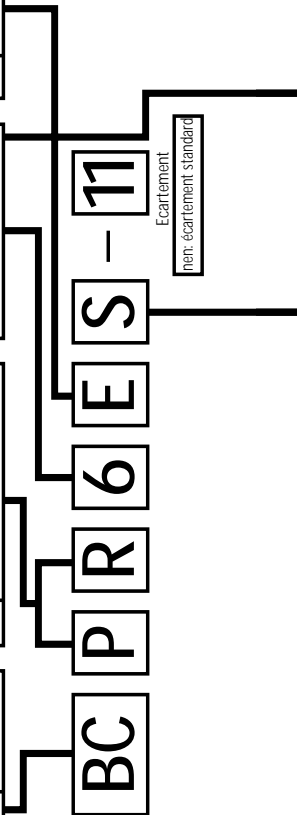

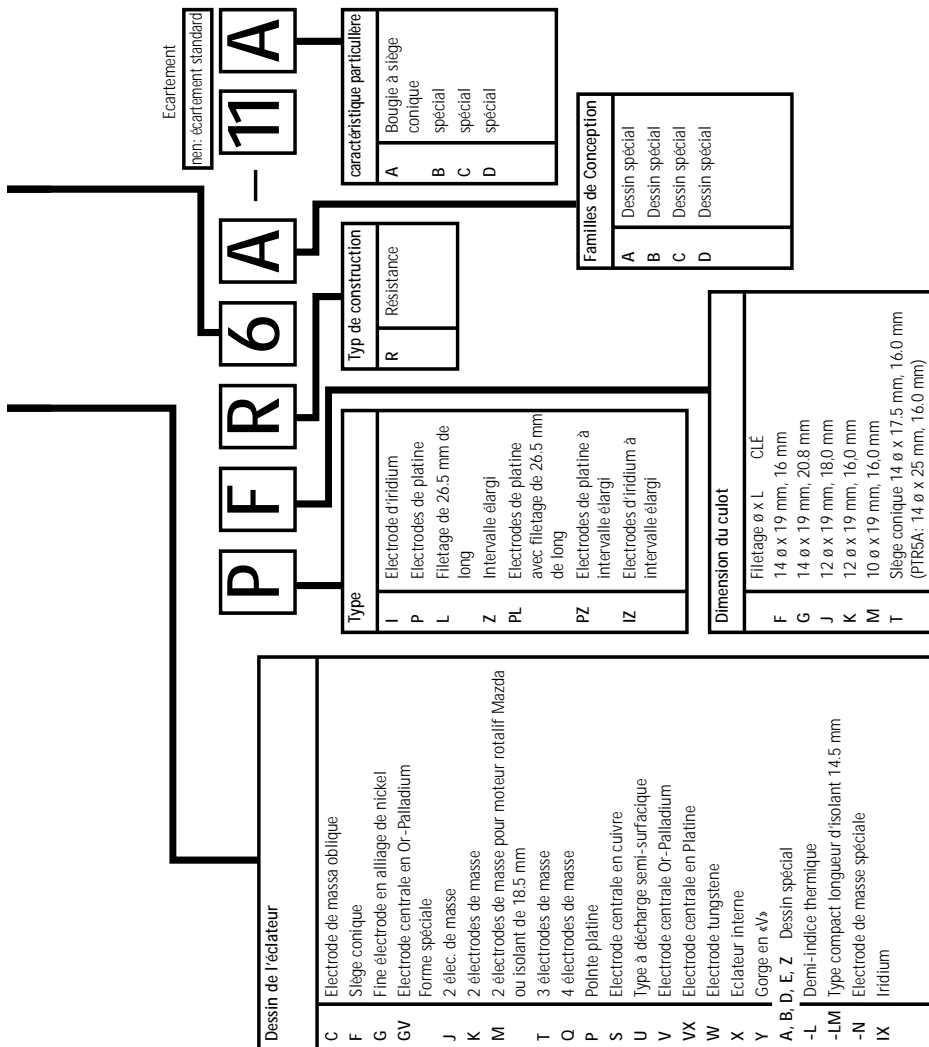

SYMBOOL VERKLARING

* standaard uitvoering. Uitzonderingen bestaan.

	Diameter	Stueltewijdte zeskant	Uitvoering	Warmtewaarde nummer	Draadlengte
A	18 mm	25,4 mm	L Mini	2 Varm	E 19,0 mm
B	14 mm	20,8 mm	M Compact type	4	H 12,7 mm
C	10 mm	16,0 mm	P Verlengde elektrode	5	L 11,2 mm
D	12 mm	18,0 mm	R Ontstoord	6	EH half draad
E	8 mm	13,0 mm	U Glijwolk of extra elektronenafstand	7	Totaal : 19,0 mm
G	PF 1/2	23,8 mm	Z Inductie weerstand type	8	Draad : 12,7 mm
J	12 mm	18,0 mm		(85)	conische zitting
AB	18 mm	20,8 mm		9	A-F 10,9 mm
BC	14 mm	16,0 mm		(95)	B-F 11,2 mm
BK	14 mm	16,0 mm		10	B-EF 17,5 mm
DC	12 mm	16,0 mm		(105)	
				11	
				12	
				13	

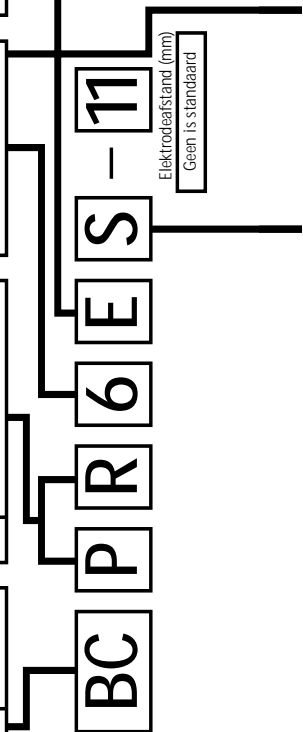

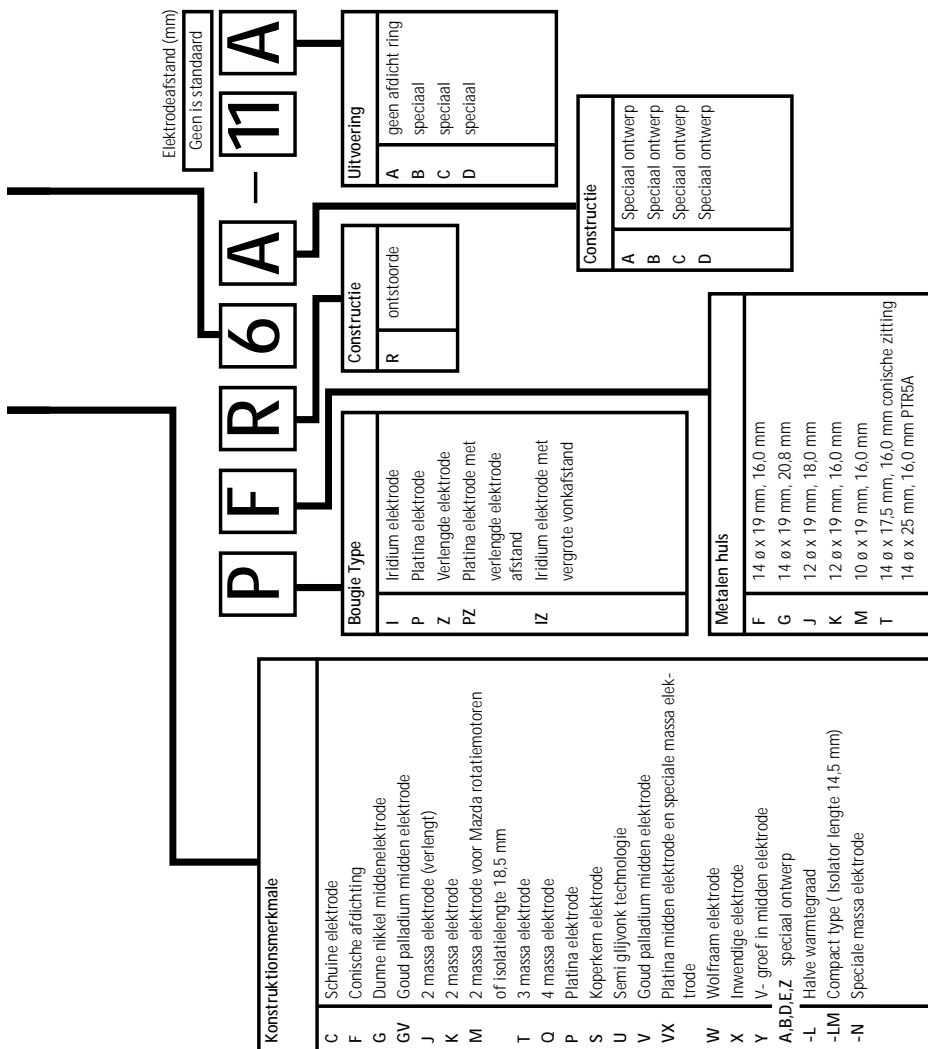

Simbolos de diseño usados en las bujías NGK

* Aquí estan indicados los tipos convencionales. También existen algunos simbolos extraordinarios.

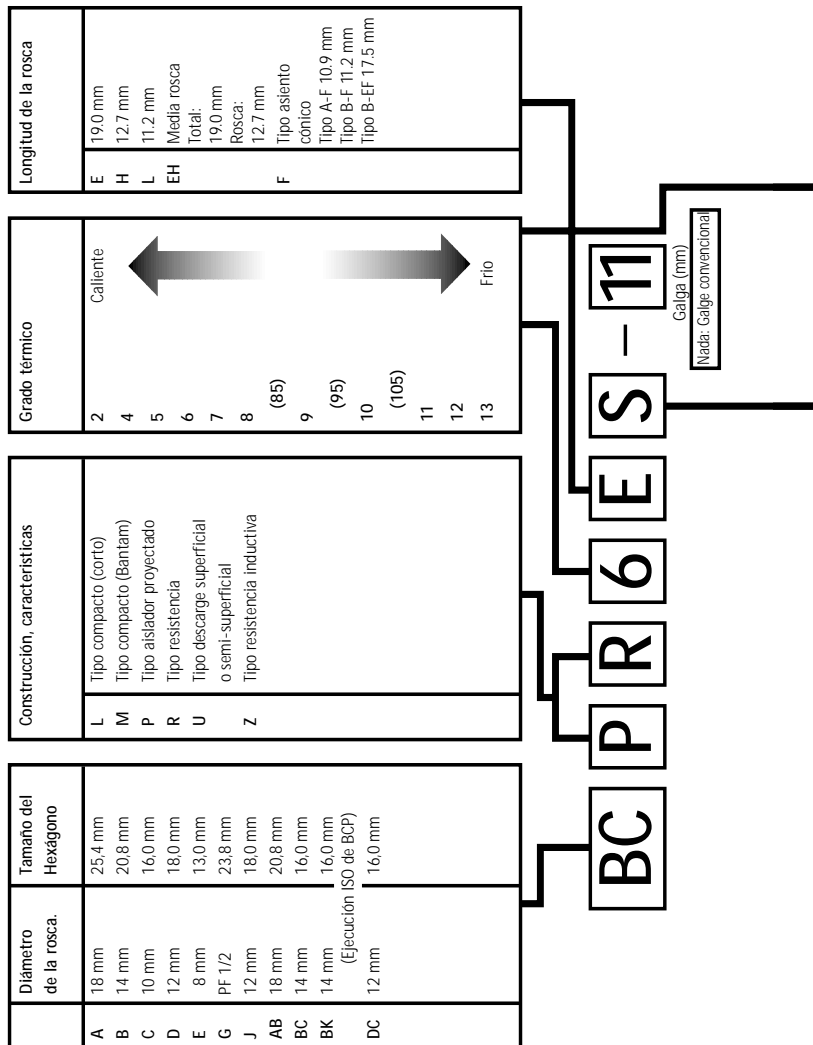

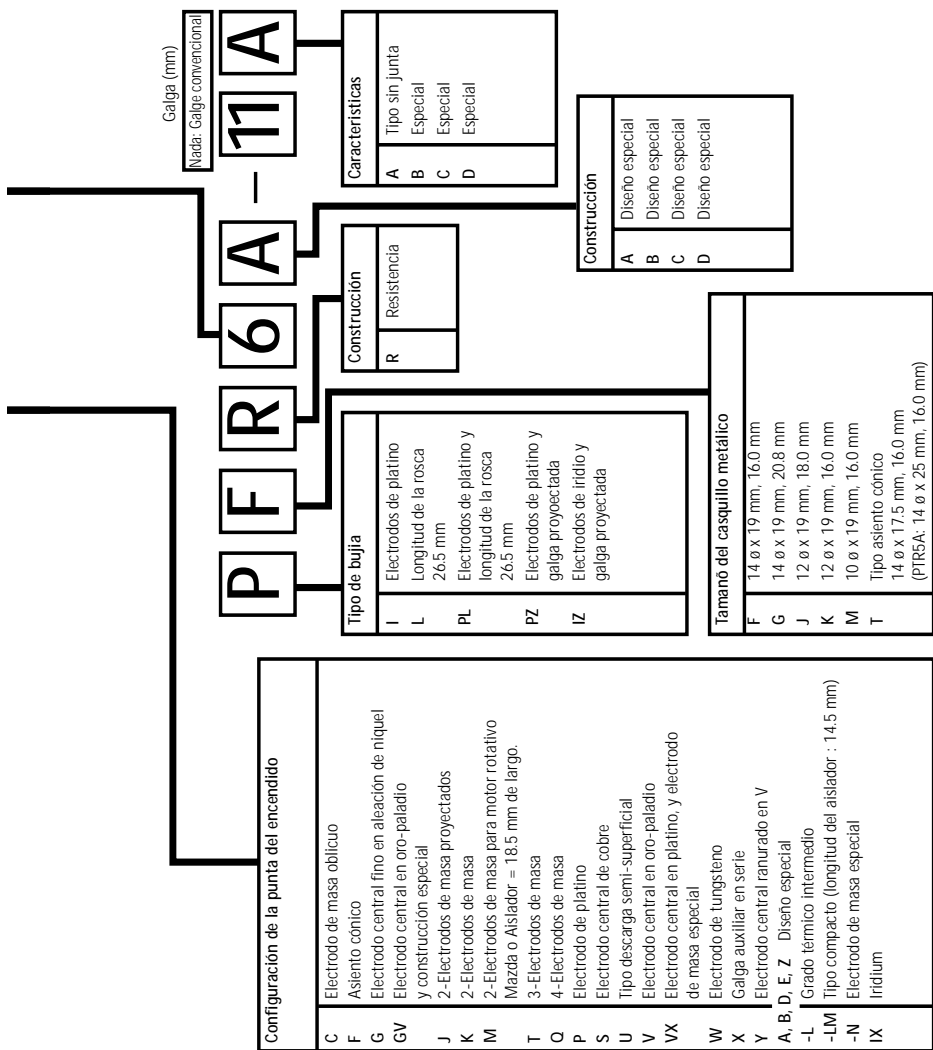

SÍMBOLOS DO DESENHO USADOS EM VELAS DE IGNIÇÃO NGK

* Aqui são desenhadas normas padrões. Também existem alguns símbolos extraordinários.

	Tamanho da rosca	Tamanho do hexágono	Característica da Construção	Numero de potência térmica	Alcance da rosca
A	18 mm	25,4 mm	L Tipo compacto (Shorty)	2 mais quente	E 19,0 mm
B	14 mm	20,8 mm	M Tipo compacto (Bantam)	4	H 12,7 mm
C	10 mm	16,0 mm	P Tipo isolador projetado	5	L 11,2 mm
D	12 mm	18,0 mm	R Tipo de resistor	6	EH Meia rosca
E	8 mm	13,0 mm	U Tipo de descarga Superficial ou Semi-surface	7	Total: 19,0 mm
G	PF 1/2	23,8 mm	Z Tipo de resistor indutivo	8	Rosca: 12,7 mm
J	12 mm	18,0 mm		(85)	Tipo de base cônica
AB	18 mm	20,8 mm		9	Tipo A-F
BC	14 mm	16,0 mm		(95)	10,8 mm
BK	14 mm	16,0 mm		10	Tipo B-F
	(Tipo de ISO do BCP)	16,0 mm		(105)	11,2 mm
DC	12 mm	16,0 mm		11	Tipo B-EF
				12	17,5 mm
				13	

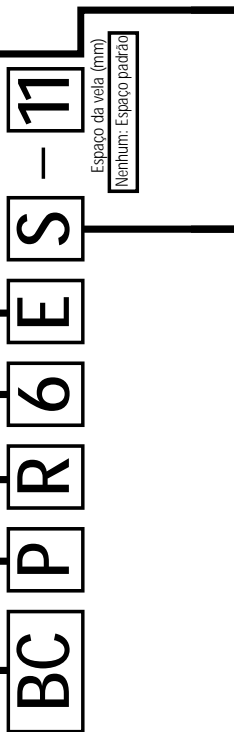

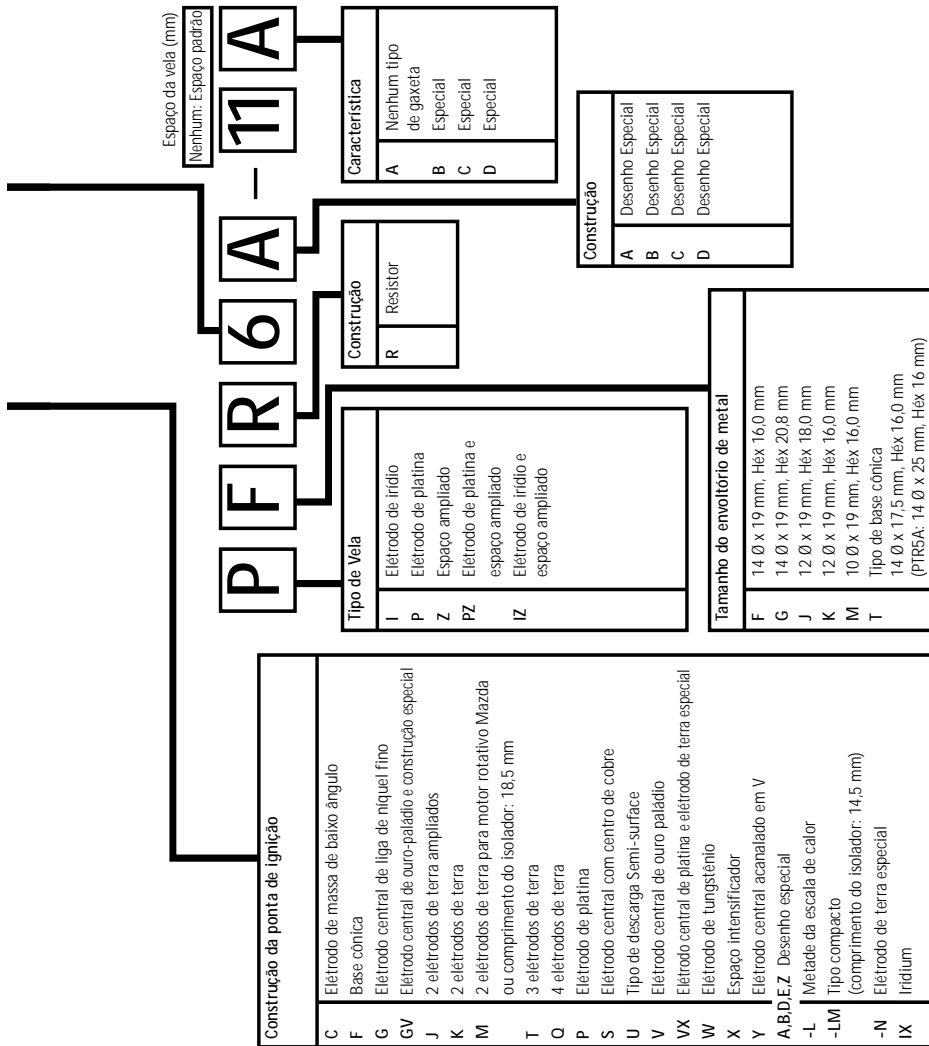

DECODIFICA DEI CODICI CANDELE NGK

La seguente tabella indica i principali codici. Sono possibili comunque ulteriori simboli.

	Diametro filettatura	Esagono	Struttura	Grado Termico	Lunghezza filettatura
A	18 mm	25,4 mm	L Tipo compatto	2	19,0 mm
B	14 mm	20,8 mm	M Tipo bantam	4	12,7 mm
C	10 mm	16,0 mm	P Punta dell'isolatore prominente	5	11,2 mm
D	12 mm	18,0 mm	R Tipo resistivo	6	Parzialmente filettata
E	8 mm	13,0 mm	U Scarica superficiale o semisuperficiale.	7	Lunghezza totale: 19,0 mm
G	PF 1/2	23,8 mm	Z Resistore induttivo	8	Filettatura : 12,7 mm
J	12 mm	18,0 mm		(85)	
AB	18 mm	20,8 mm		9	Sede conica
BC	14 mm	16,0 mm		(95)	Tipo A-F
BK	14 mm	16,0 mm		10	10,9 mm
	(versione ISO del tipo BCP)			(105)	Tipo B-F
DC	12 mm	16,0 mm		11	11,2 mm
				12	Tipo B-EF
				13	17,5 mm

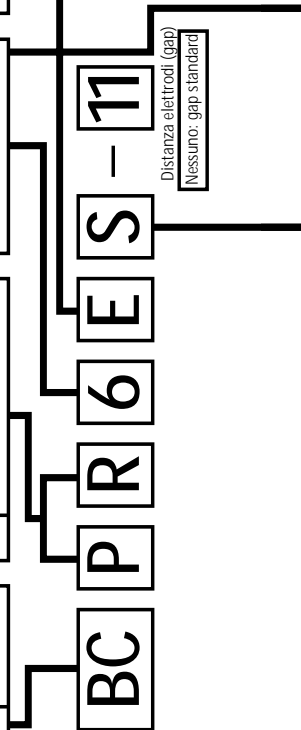

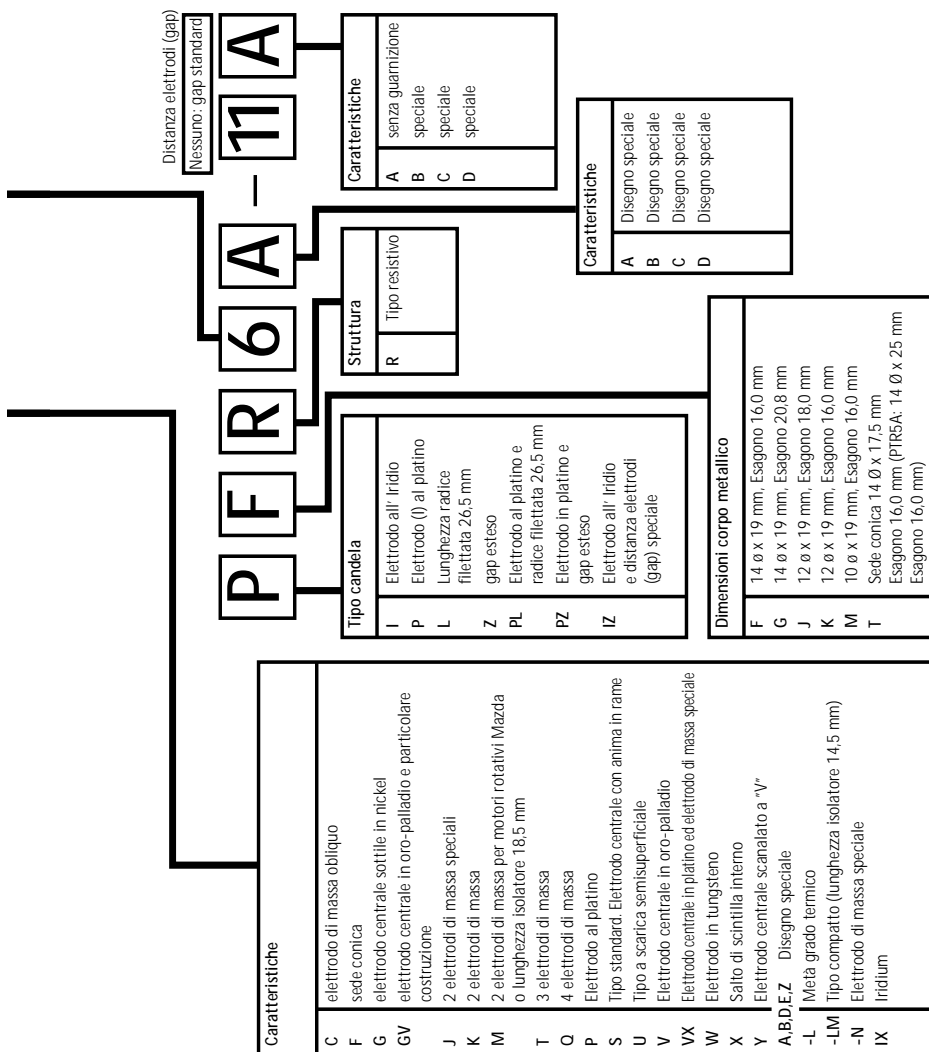

MARKERINGSTEGN PÅ NGK TÆNDRØR

* Standardtypepåskriften er anført her.

	Gevind-diameter	Negle-størrelse	Struktur	Varmeværdi	Gevindlængde	
A	18 mm	25,4 mm	L Bantamrør M Kompakt type P Fremskuert isolator R Radiostøjdempet U Lufttildignisteknik Z Afbrændingsmodstand	2	E 19,0 mm	
B	14 mm	20,8 mm		4	H 12,7 mm	
C	10 mm	16,0 mm		5	L 11,2 mm	
D	12 mm	18,0 mm		6	EH	Gevind i halv udførsel
E	8 mm	13,0 mm		7		I alt: 19,0 mm
G	PF 1/2	23,8 mm		8		Gevind: 12,7 mm
J	12 mm	18,0 mm		(85)		Typen med konisk gevind
AB	18 mm	20,8 mm		9		A-F type 10,9 mm
BC	14 mm	16,0 mm		(95)		B-F type 11,2 mm
BK	14 mm	16,0 mm		10		B-EF type 17,5 mm
DC	12 mm	16,0 mm		(105)	11	
					12	
					13	

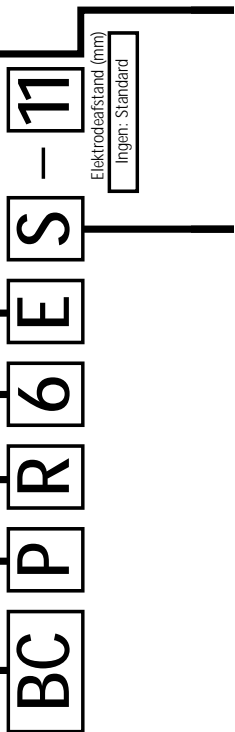

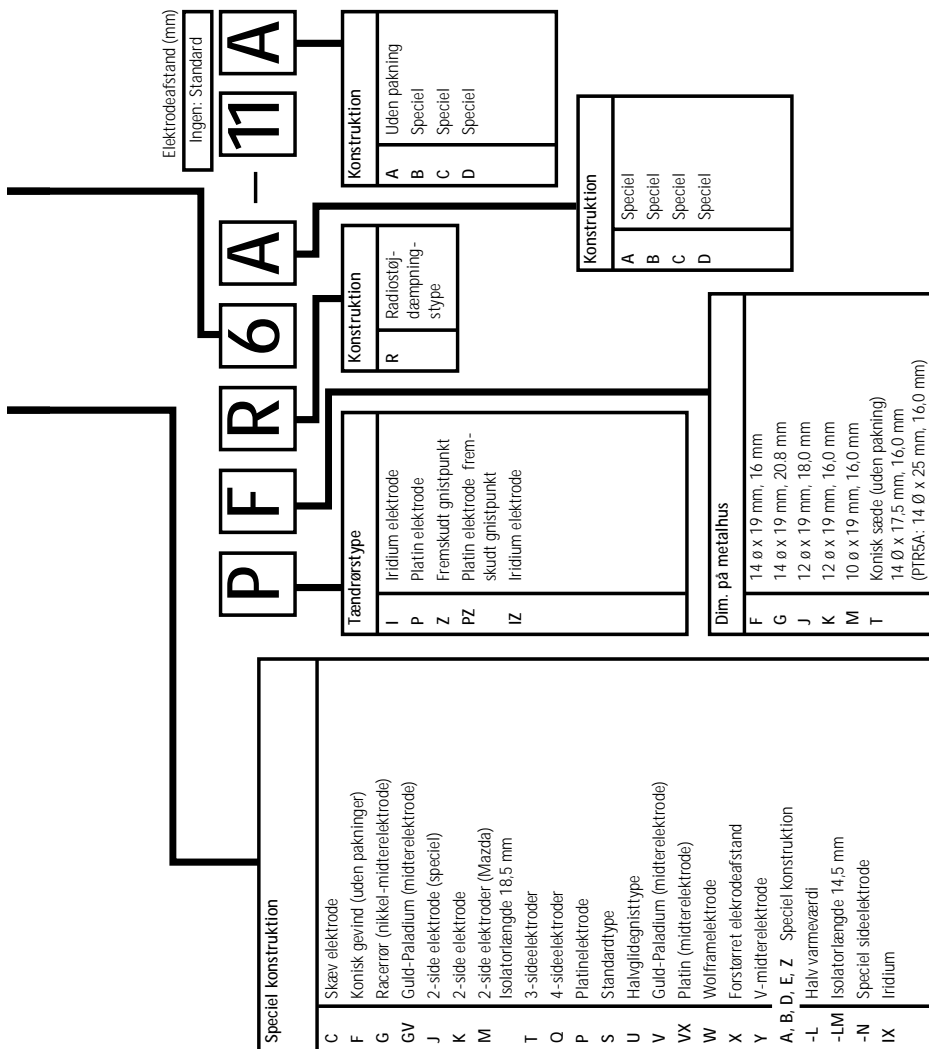

TEKNISKE SYMBOLER BRUKT I NGK TENNPLUGGER

* Standardregulering er vist her. Det finnes også noen spesielle symboler.

	Gjengestørrelse	Sekskantstørrelse	Konstruksjonsegenskaper	Varmekapasitet	Gjengeskruedybde
A	18 mm	25,4 mm	L Kompakt type (Shorry)	2 Varmere	E 19,0 mm
B	14 mm	20,8 mm	M Kompakt type (Bantam)	4	H 12,7 mm
C	10 mm	16,0 mm	P Frenspringende isolatortype	5	L 11,2 mm
D	12 mm	18,0 mm	R Motstandstype	6	EH Halv gjenge
E	8 mm	13,0 mm	U Surface- eller Semi-Surface- utladingstype	7	Total: 19 mm
G	PF 1/2	23,8 mm	Z Induktiv motstandstype	8	Gjenge: 12,7 mm
J	12 mm	18,0 mm		(85)	Konisk setetype
AB	18 mm	20,8 mm		9	Type A-F 10,9 mm
BC	14 mm	16,0 mm		(95)	Type B-F 11,2 mm
BK	14 mm	16,0 mm		10	Type B-EF 17,5 mm
DC	12 mm	(ISO-type av BCP) 16,0 mm		11	
				12	
				13	

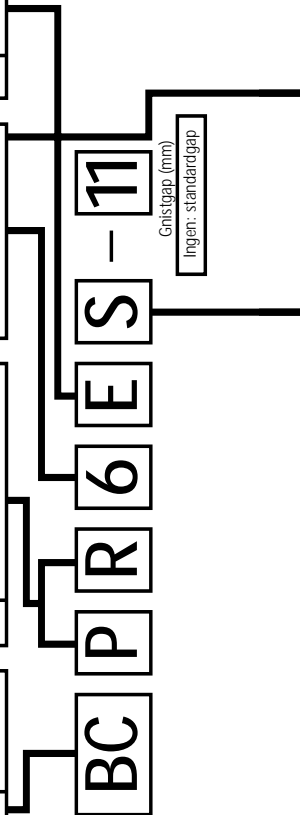

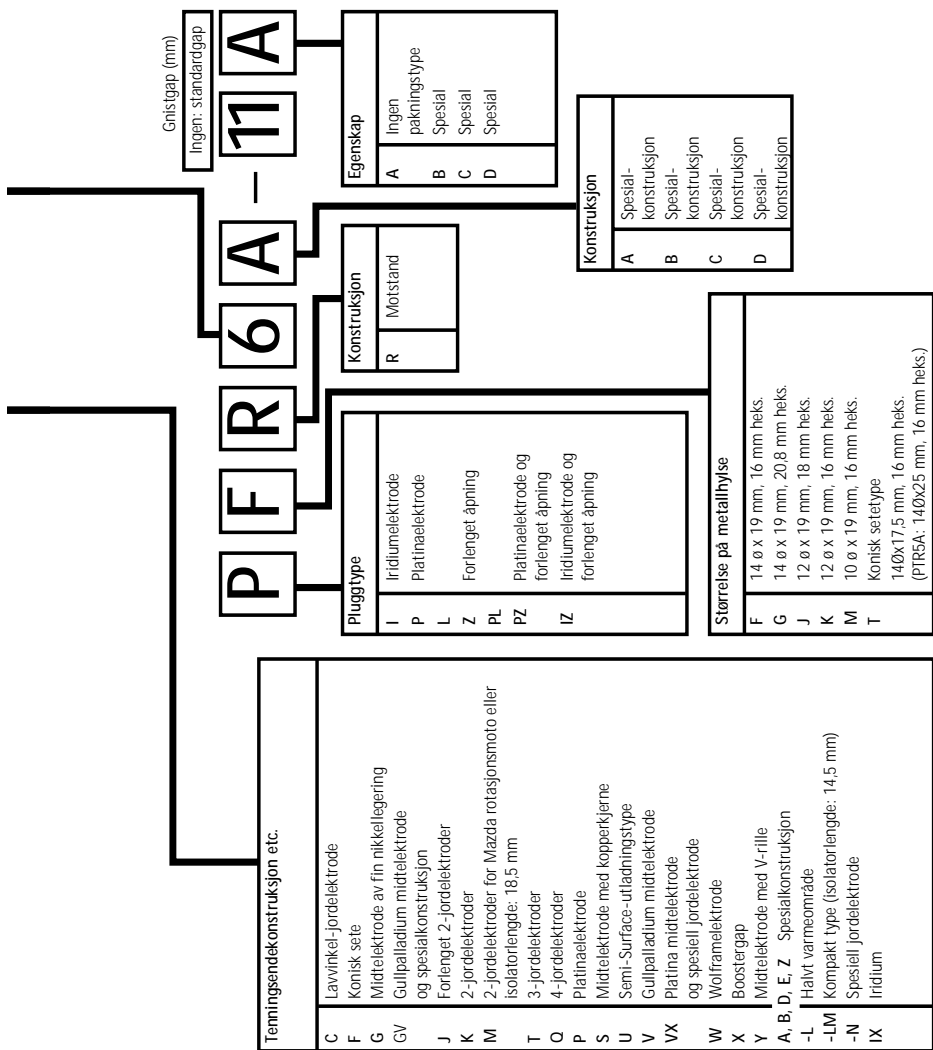

NGK-SYTYTYSTULPPIEN TYYPPIMERKINNÄT

* Tässä on esitetty normaalisäädöt. Näiden lisäksi on erikoismerkintöjä.

	Kierteen koko	Kuusikulmion koko	Rakennemuotoisuus	Lämpöarvo	Kierteen pituus
A	18 mm	25,4 mm	L Kompakti (Shorty)	2	E 19,0 mm
B	14 mm	20,8 mm	M Kompakti (Bantam)	4	H 12,7 mm
C	10 mm	16,0 mm	P Ulkoneuva eriste	5	L 11,2 mm
D	12 mm	18,0 mm	R Resistori	6	EH Puolikierre
E	8 mm	13,0 mm	U Pintaa- tai puolipintapurkaus	7	Kokonaispituus: 19,0 mm
G	PF 1/2	23,8 mm	Z Induktiivinen resistori	8	Kierre: 12,7 mm
J	12 mm	18,0 mm		(85)	Kartiomainen
AB	18 mm	20,8 mm		9	Tyyppi A-F 10,9 mm
BC	14 mm	16,0 mm		(95)	Tyyppi B-F 11,2 mm
BK	14 mm	16,0 mm		10	Tyyppi B-EF 17,5 mm
		(BCP:n ISO-tyyppi) 16,0 mm		(105)	
DC	12 mm	16,0 mm		11	
				12	
				13	

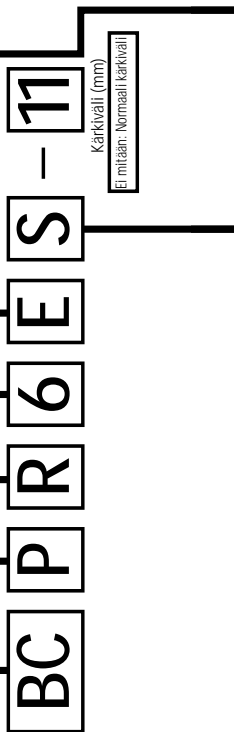

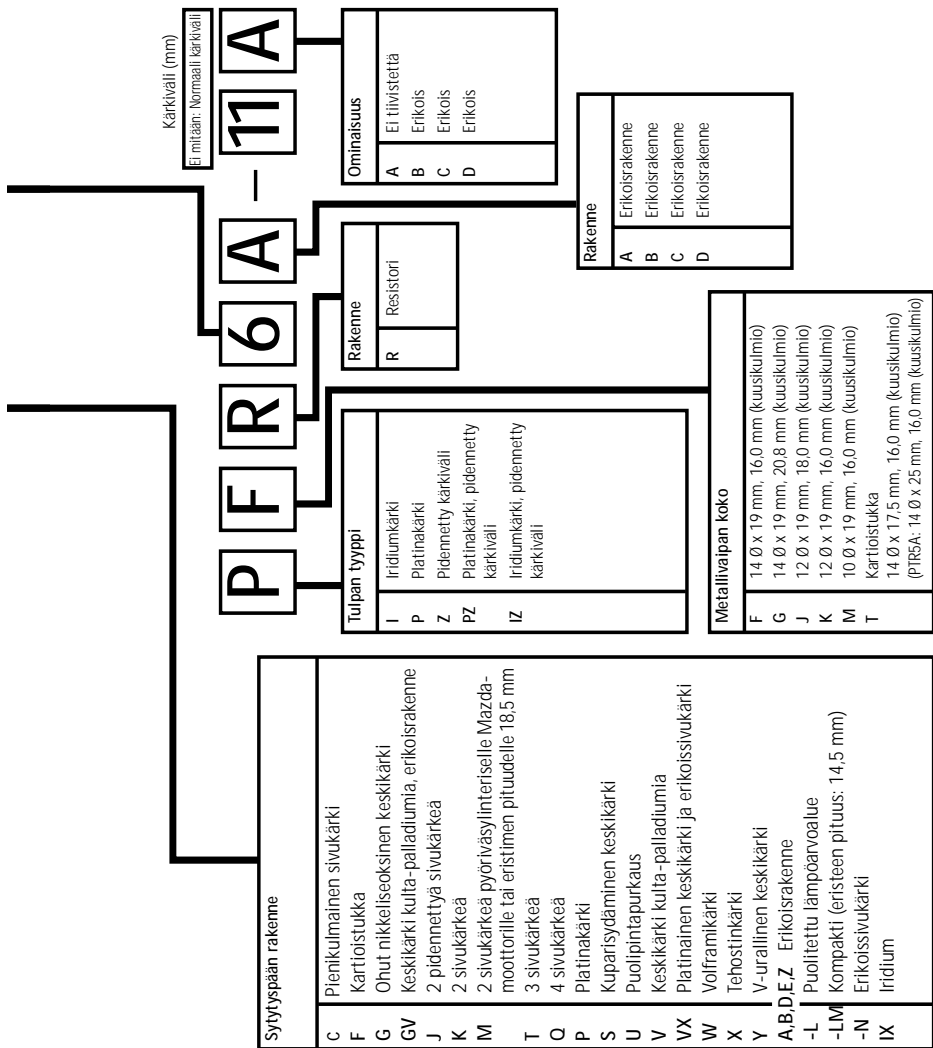

NGK SÜÜTEKÜÜNLA SÜMBOLITE SELGITUSED

	Keeme läbimõõt	Kuusikant	Ehitus	Hõõganv Soojusväärtus	Keeme pikkus
A	18 mm	25,4 mm	L	2	E 19,0 mm
B	14 mm	20,8 mm	M	4	H 12,7 mm
C	10 mm	16,0 mm	P	5	L 11,2 mm
D	12 mm	18,0 mm	R	6	EH Keere ainult pooleni
E	8 mm	13,0 mm	U	7	Kogupikkus: 19,0 mm
G	PF 1/2	23,8 mm	Z	8	Keere: 12,7 mm
J	12 mm	18,0 mm		(85)	Koonustihendi tüüp
AB	18 mm	20,8 mm		9	F
BC	14 mm	16,0 mm		(95)	
BK	14 mm	16,0 mm		10	A-F tüüp 10,9 mm
		ISO tüüp BCP-st		(105)	B-F tüüp 11,2 mm
				11	B-EF tüüp 17,5 mm
DC	12 mm	16,0 mm		12	
				13	

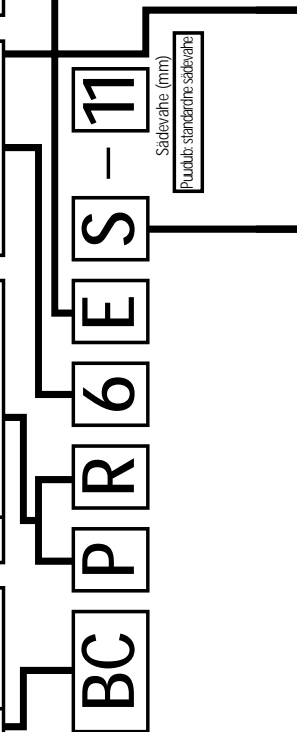

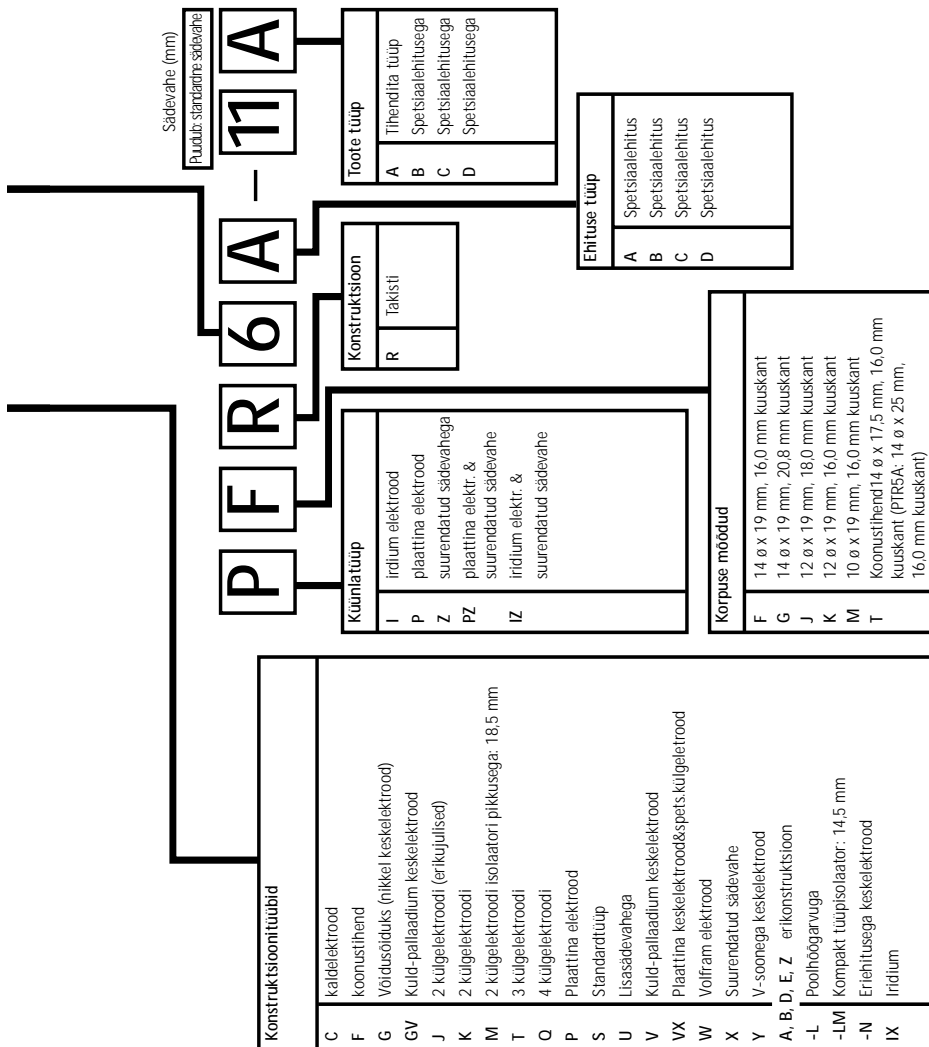

ZNAČENÍ POUŽÍVANÉ U ZAPALOVACÍCH SVÍČEK NGK

* Na obrázku je uvedeno standardní značení. Existuje ještě několik speciálních symbolů.

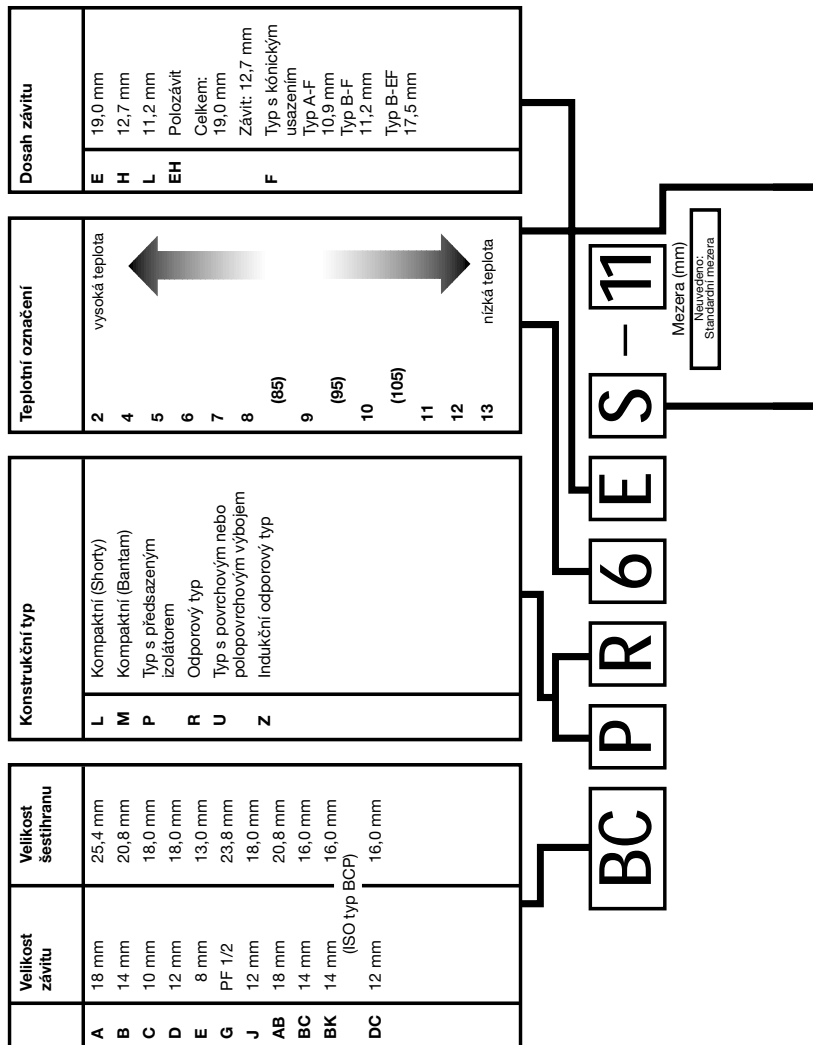

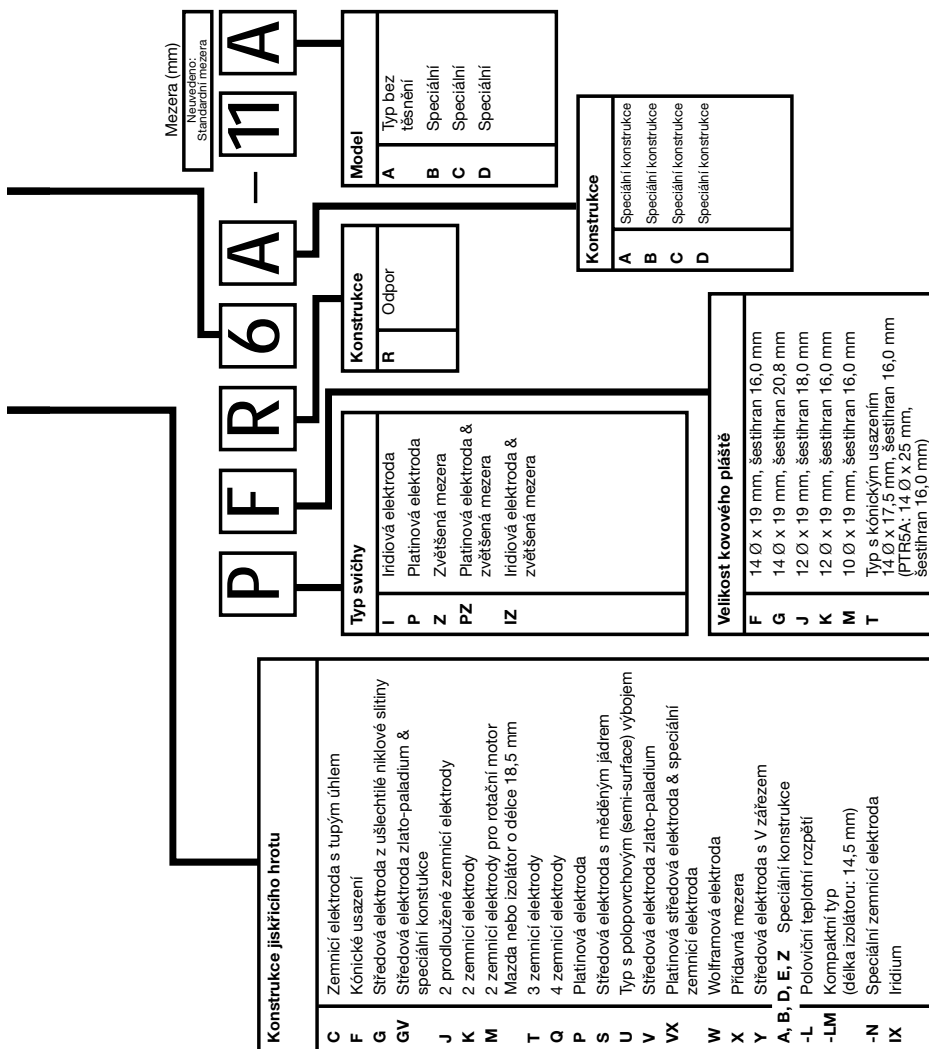

OZNACZENIA ŚWIEC ZAPŁONOWYCH NGK

	średnica gwintu	rozwartość klucza sześciokątnego	rodzaj budowy	wartość cieplinal	długość gwintu
A	18 mm	25.4 mm	L typ baniam	2	E 19.0 mm
B	14 mm	20.8 mm	M tap kompaktowy	4	H 12.7 mm
C	10 mm	16.0 mm	P wyciągnięta końcówka izolatora	5	L 11.2 mm
D	12 mm	18.0 mm	R opornik przeciwwzrostowy	6	EH gwint wykonany do połowy
E	8 mm	13.0 mm	U iskra ślizgowa lub dodatkowa	7	łącznie: 19.0 mm
G	PF 1/2	23.8 mm	Z opornik indukcyjny	8	gwint: 12.7 mm
J	12 mm	18.0 mm		(85)	uszczelnienie stożkowe
AB	18 mm	20.8 mm		9	typ A-F:
BC	14 mm	16.0 mm		(95)	10.9 mm
BK	14 mm	16.0 mm		10	typ B-F:
	(wersja ISO serii BCP)			(105)	11.2 mm
DC	12 mm	16.0 mm		11	typ B-EF:
				12	17.5 mm
				13	

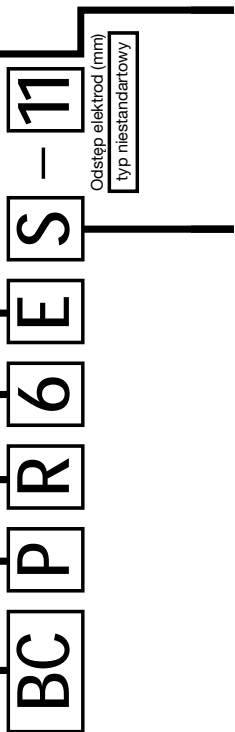

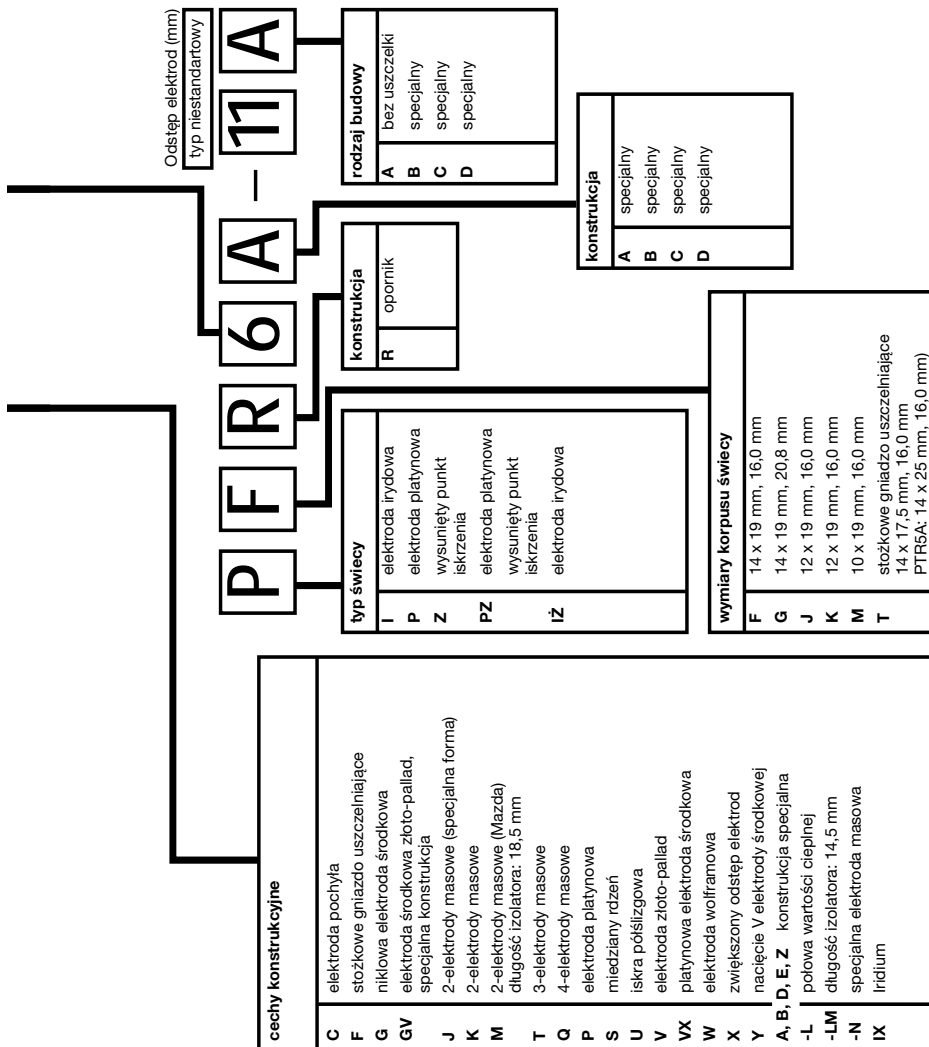

МАРКИРОВАЧНЫЕ МЕТКИ НА СВЕЦАХ ЗАЖИГАНИЯ ФИРМЫ NGK

* Здесь указаны стандартные обозначения. Также имеются несколько нестандартных обозначений.

Диаметр резьбы	Размер 6-гранного ключа	Особенности конструкции	Калильное число	Длина резьбы
A	18 мм	L	2	E
B	14 мм	M	4	H
C	10 мм	P	5	L
D	12 мм	R	6	EH
E	8 мм	U	7	резьба до середины
G	PF 1/2	Z	8	Общая длина: 19,0 мм
J	12 мм		9	Длина резьбы: 12,7 мм
AB	18 мм		(85)	Конусное седло
BC	14 мм		(95)	A-F тип 10,9 мм
BK	14 мм		(105)	B-F тип 11,2 мм
DC	12 мм		10	B-EF тип 17,5 мм
			11	
			12	
			13	

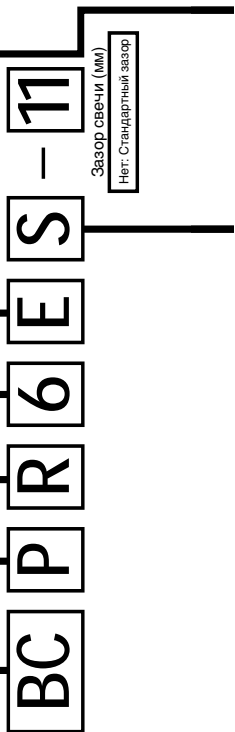
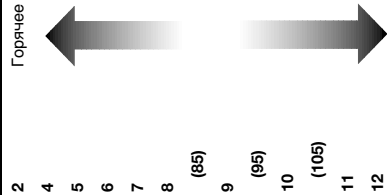

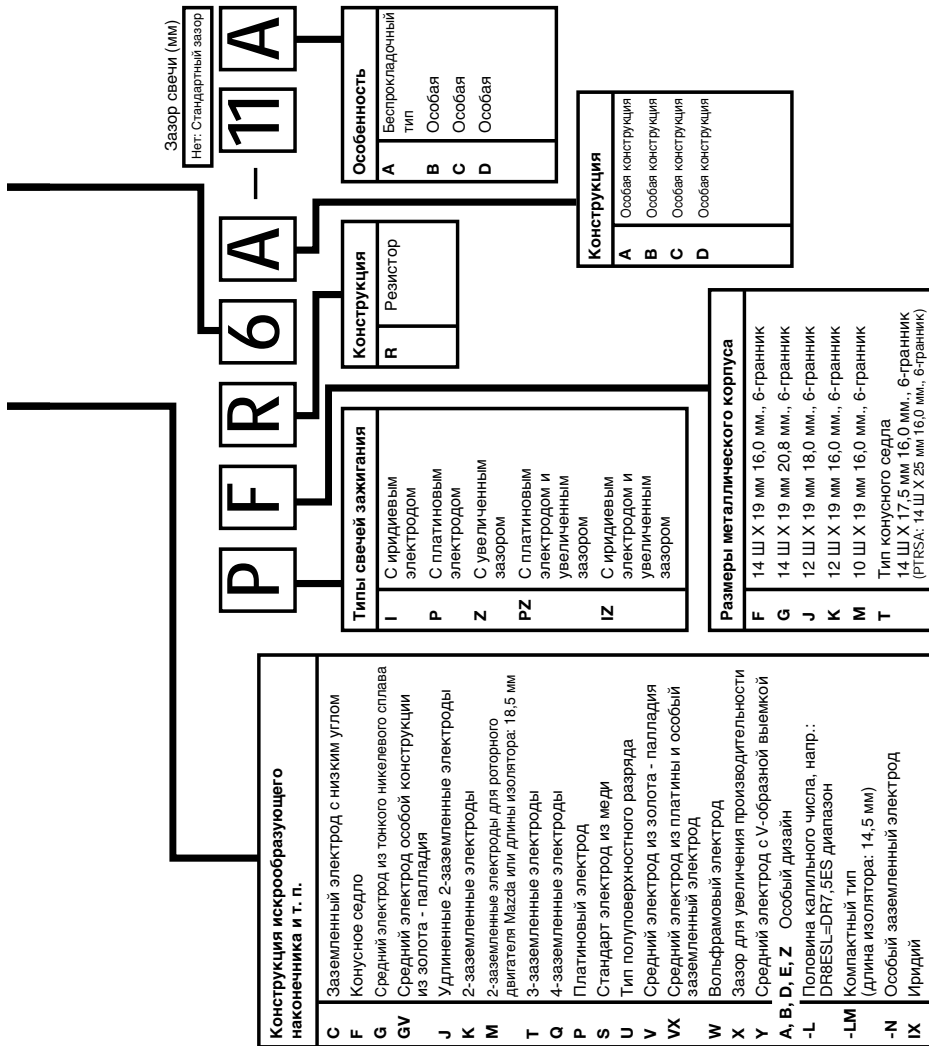

NGK GYÚJTÓGYERTYA JELZÉSEK MAGYARÁZATA

* Csak az általános típusok magyarázata, néhány extrém típust nem tartalmaz.

MENETÁTMÉRŐ		KULCSNYÍLÁS		KIVITEL		HŐÉRTÉK		MENETHOSSZ	
A	18 mm	25,4 mm	L	kompakt típus (fővíd)	2	meleg (kis hőérték)		E	19,0 mm
B	14 mm	20,8 mm	M	kompakt típus (Bantam)	4		H	12,7 mm	
C	10 mm	16,0 mm	P	előrehúzott szigetelőcsúcs	5		L	11,2 mm	
D	12 mm	18,0 mm	R	zavarszűrés ellenállással	6		EH	nem végig menetes teljes hossz: 19,0 mm	
E	8 mm	13,0 mm	U	küszöszikra, vagy járulékos szikrakódz	7			menethossz: 12,7 mm	
G	PF 1/2	23,8 mm	Z	zavarszűrés induktivitással	8			F	kúpos ulék A-F 10,9 mm B-F 11,2 mm B-EF 17,5 mm
J	12 mm	18,0 mm			8		(85)		
AB	18 mm	20,8 mm			9		(95)		
BC	14 mm	16,0 mm			10		(105)		
BK	14 mm	16,0 mm			11				
DC	12 mm	16,0 mm			12				
					13		hideg (nagy hőérték)		

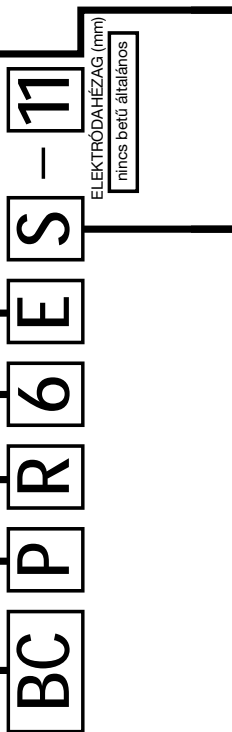

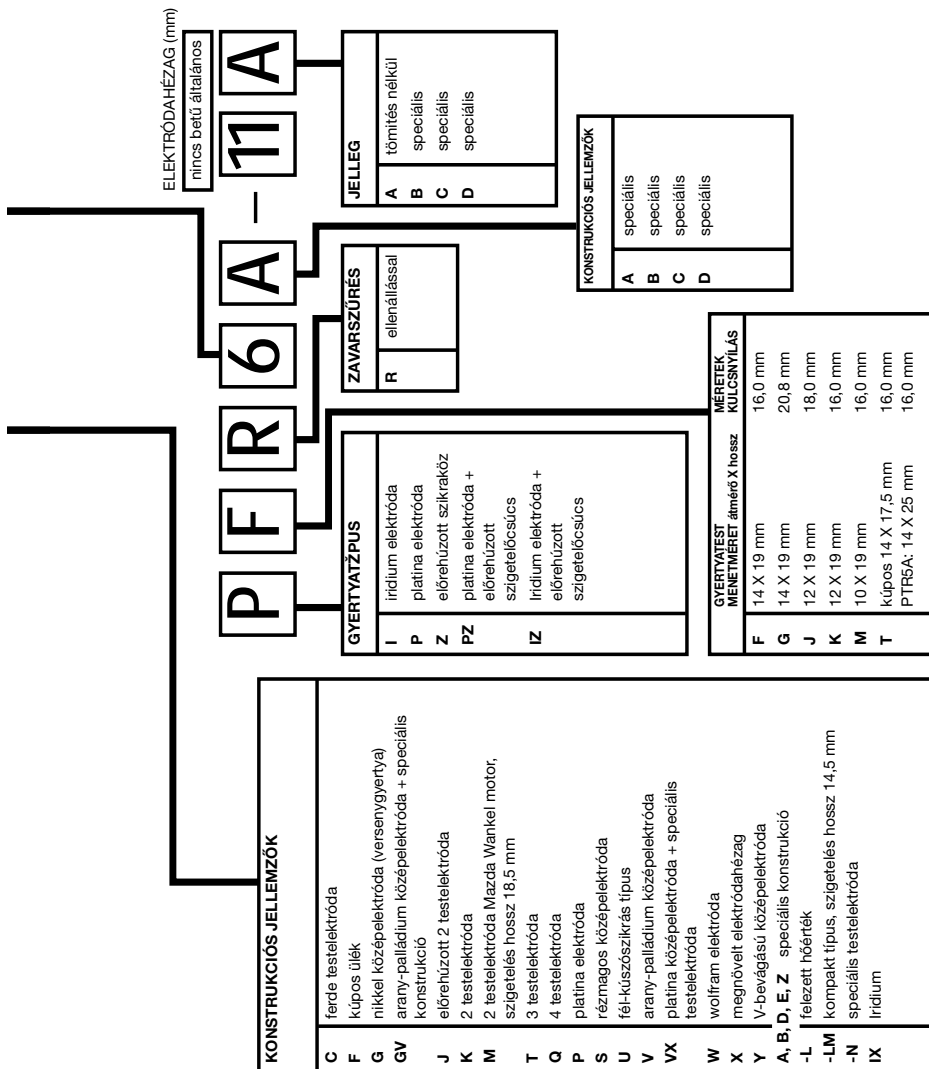

ΣΥΜΒΟΛΑ ΣΧΕΔΙΑΣΗΣ ΠΟΥ ΧΡΗΣΙΜΟΠΟΙΟΥΝΤΑΙ ΣΤΑ ΜΠΟΥΖΙ NGK

* Χρησιμοποιούνται οι συνήθεις κανονισμοί. Υπάρχουν επίσης ορισμένα ασυνήθιστα σύμβολα

Μέγεθος σπειρώματος	Εξωτερικό μέγεθος	Τύπος κατασκευής	Αριθμός θερμοκρασιακής κατάταξης	Απόσταση σπειρώματος
A	18 mm	L Συμπαγής τύπος (Shorty)	2	E 19,0 mm
B	14 mm	M Συμπαγής τύπος (Bantam)	4	H 12,7 mm
C	10 mm	P Τύπος με προεξέχοντα μονωτήρα	5	L 11,2 mm
D	12 mm	R Τύπος με αντίσταση	6	EH Σπειρώμα κατά το ήμισυ
E	8 mm	U Τύπος εκφόρτισης επιφάνειας	7	Σύνολο: 19,0 mm
G	PF 1/2	Z Τύπος με επαγωγική αντίσταση	8	Σπειρώμα: 12,7 mm
J	12 mm		(85)	
AB	18 mm		9	Τύπος κωνικής βάσης
BC	14 mm		(95)	Τύπος A-F
BK	14 mm		10	10,9 mm
DC	14 mm		(105)	Τύπος B-F
	12 mm		11	11,2 mm
			12	Τύπος B-EF
			13	17,5 mm

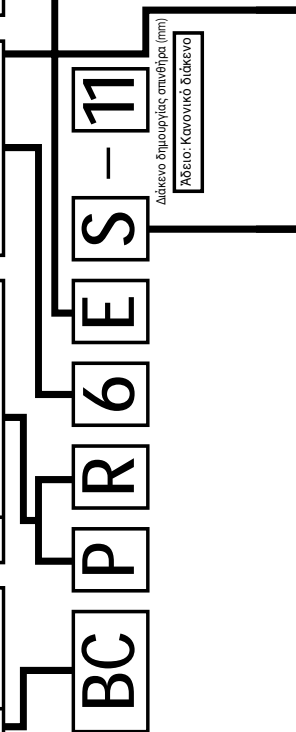

Διάκενο δημιουργίας σπινθήρα (mm)

Λέειο: Κανονικό διάκενο

P F R 6 A - 11 A

Τύπος	
A	Τύπος χωρίς παρέμβλημα
B	Ειδικός
C	Ειδικός
D	Ειδικός
.	.
.	.

Κατασκευή	
R	Αντίσταση

Τύπος μπουζί	
I	Ηλεκτρόδιο ιριδίου
P	Ηλεκτρόδιο από πλατίνα
Z	Προεκτεταμένο διάκενο
PZ	Ηλεκτρόδιο από πλατίνα και προεκτεταμένο διάκενο
IZ	Ηλεκτρόδιο ιριδίου και προεκτεταμένο διάκενο

Κατασκευή	
A	Ειδική σχεδίαση
B	Ειδική σχεδίαση
C	Ειδική σχεδίαση
D	Ειδική σχεδίαση
.	.
.	.

Μέγεθος μεταλλικού κελύφους	
F	14 Ø X 19 mm, 16,0 mm εξαγωνικό
G	14 Ø X 19 mm, 20,8 mm εξαγωνικό
J	12 Ø X 19 mm, 18,0 mm εξαγωνικό
K	12 Ø X 19 mm, 16,0 mm εξαγωνικό
M	10 Ø X 19 mm, 16,0 mm εξαγωνικό
T	Τύπος κωνικής βάσης 14 Ø X 17,5 mm, 16,0 mm εξαγωνικό (PTBFA: 14 Ø X 25 mm, 16,0 mm εξαγωνικό)

Κατασκευή άκρου ανάφλεξης, κ.λπ.	
C	Ηλεκτρόδιο γείωσης μικρής κλίσης
F	Κωνική βάση
G	Κεντρικό ηλεκτρόδιο επεξεργασμένου κράματος νικελίου
GV	Κεντρικό ηλεκτρόδιο χρυσού - παλλαδίου και ειδική κατασκευή
J	2 προεκτεταμένα ηλεκτρόδια γείωσης
K	2 ηλεκτρόδια γείωσης
M	2 ηλεκτρόδια γείωσης για περιστροφικούς κινητήρες Mazda ή Μήκος μονωτήρα: 18,5 mm
T	3 ηλεκτρόδια γείωσης
O	4 ηλεκτρόδια γείωσης
P	Ηλεκτρόδιο από πλατίνα
S	Κεντρικό ηλεκτρόδιο με πυρίνα από χαλκό
U	Τύπος εκφόρτισης ημι-επιφάνειας
V	Κεντρικό ηλεκτρόδιο χρυσού - παλλαδίου
VX	Κεντρικό ηλεκτρόδιο από πλατίνα και ειδικό ηλεκτρόδιο γείωσης
W	Ηλεκτρόδιο βοκφραμίου
X	Διάκενο ενίσχυσης
Y	Κεντρικό ηλεκτρόδιο με αύλακα σε σχήμα V
A, B, E, Z	Ειδική σχεδίαση
-L	Μισό εύρος θερμοκρασίας
-LM	Συμπληγής τύπος (Μήκος μονωτήρα: 14,5 mm)
-N	Ειδικό ηλεκτρόδιο γείωσης
IX	Iridium

NGK bujilerinin üzerindeki karakterler ve açıklamaları.

Birçok tanım mevcut olup aşağıda tipik bir örnek verilmiştir.

	Dış çapı	Anahtar ağzı	Yapısal özellik	Isı değeri	Paso uzunluğu
A	18 mm	25,4 mm	L Bantam tipi	2	E 19,0 mm
B	14 mm	20,8 mm	M Kompakt tip	4	H 12,7 mm
C	10 mm	16,0 mm	P One alınmış izolatör uç	5	L 11,2 mm
D	12 mm	18,0 mm	R Dirençli tip	6	EH Yanm yiv
E	8 mm	13,0 mm	U Bosalım tipi yada ilave kıvılcım yolu	7	F Toplam uzunluk: 19,0 mm
G	PF 1/2	23,8 mm	Z Dirençli tip (endüktif)	8	F Yiv uzunluğu: 12,7 mm
J	12 mm	18,0 mm		(85)	F Konik gövdeli tip
AB	18 mm	20,8 mm		9	F A-F Tip 10,9 mm
BC	14 mm	16,0 mm		(95)	F B-F Tip 11,2 mm
BK	14 mm	16,0 mm		10	F B-EF Tip 17,5 mm
DC	12 mm	16,0 mm		(105)	
				11	
				12	
				13	

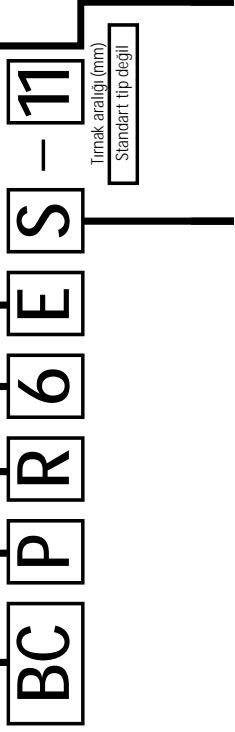

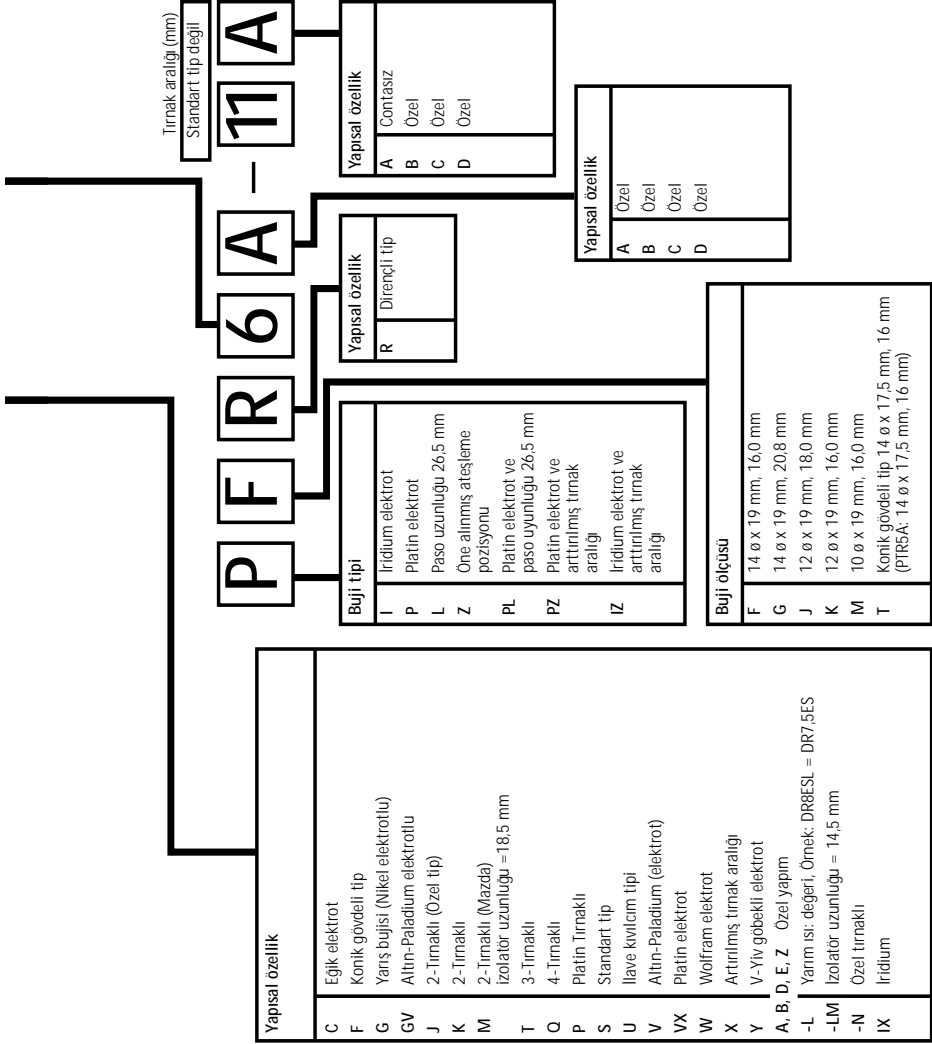

Conversion Chart

Vergleichsliste

Tableau de comparaison thermique

Tabla de conversión equivalencias

Jämförelsetabell

Note: This chart is furnished as a guide. Due to differences in design, materials, etc., plugs produced by various manufacturers do not have exactly the same heat range. See recommendations sections for specific engine application.

Anmerkung: Diese Liste dient nur zur Information. Wegen der Unterschiede von Konstruktion, Werkstoffen usw. haben die Zündkerzen von verschiedenen Herstellern keinen miteinander übereinstimmenden Wärmebereich. Siehe unsere Empfehlungen für die richtige Anwendung der Zündkerzen.

Notes: Cette liste est donnée comme guide. A cause de la différence en dessin, matériels etc., les bougies d'allumage produites par divers fabricans n'ont pas exactement la même gamme thermique. Voir section d'affectations pour utilisation exacte.

Notas: Este cuadro se sirve de guía. Bujías que se producen por varios fabricantes no poseen exactamente el mismo alcance térmico debido a las diferencias en diseño, materiales etc. Véase sección de aplicaciones para el uso correcto.

Observera: Denna tabell är endast avsedd som vägledning. På grund av avvikelser i utförande, material m.m. kan tändstift av olika fabrikat ej ha exakt samma värmetal. Se rekommendationstabellen för respektive motor.



BERU	→ NGK
125/14/3	B5ES
125/14/3A	BP5ES
12-5DU	D7EA
14-10A	B4H
14-10B	BP4HS
14-10C	B4ES
14-10D	BP4ES
14-10E	B4
14-10F	BP4
14-2AS1	B9HCS
14-3A1	B8HS
14-3AS1	B8HVX
14-3AU	B8HS
14-3CS1	B8EVX
14-3DP2	B8EVX
14-4A1	B8HS
14-4A2	B7HS
14-4AS1	B8HVX
14-4AU	B7HS
14-4B2	BP7HS
14-4C1	B8ES
14-4C2	B7ES
14-4CS1	B8EVX
14-4DPO	BP7ES
145/14	B5HS
145/14/3	B5ES
145/14/3A	BP5ES
145/14/5	B4
145/14/5A	BP5S
145/14/5AMX	BPM6A
145/18	A6
145/18K	AP5FS
145/1A	BP5HS
14-5A	B7HS
14-5AU	B7HS
14-5B	BP7HS
14-5BU	BP7HS
14-5C	B7ES
14-5CS	B7ECS
14-5D	BP7ES
14-5D1	BP7ES
14-5DP1	BP7ES
14-5DTU	BP6ET
14-5DU	BP7ES
14-5DUO	BP7ES
14-5E	B7S
14-5F	BP6S
14-6B	BP6HS
14-6BU	BP6HS
14-6C	B6ES
14-6D	BP6ES
14-6D1	BP6ES

BERU	→ NGK
14-6DPO	BP6ES
14-6DTU	BP6ET
14-6DU	BP6ES
14-6DUO	BP6ESZ
14-7A	B6HS
14-7AU	B6HS
14-7B	BP6HS
14-7BU	BP6HS
14-7C	B6ES
14-7CU	B6ES
14-7D	BP6ES
14-7DTU	BP6ET
14-7DU	BP6ES
14-7DUO	BP6ESZ
14-7E	B6S
14-7F	BP6S
14-8A	B5HS
14-8AU	B5HS
14-8B	BP5HS
14-8BU	BP5HS
14-8C	B5ES
14-8C1	B6ES
14-8D	BP5ES
14-8DTU	BP5ET
14-8DTU EA1,0	BP5ET-10
14-8DU	BP5ES
14-8DUO	BP5ES
14-8E	B4
14-8F	BP5S
14-8LUR	ZGR5A
14-9C	B5ES
14-9D	BP5ES
14-9DTU	BP5ET
14-9DU	BP5ES
14-9DUO	BP5ES
14-9EUO	B4LM
14F-03DAR	BKR6EK
14F4DPUR03	PFR8B-9
14F-5DU	BCP7ES
14F-6DSR	BKR6E
14F-6DTU	BCP6ET
14F-6DUO	BCP6ES
14F-6DUOR	BKR6E
14F-7DPVRXZ	IFR6D10
14F-7DU	BCP6ES
14F-7DUO	BCP6ES
14F-7DUOR	BKR6E
14F-7LDUR	BKR6EK
14F-7LDUR4	BKR6EK
14F-8DU	BCP5ES
14F-8DU4	BCP5ES
14F-8DUO	BCP5ES



BERU	→	NGK
14F-8LDUSR		BKR6EK
14F-8LUR		ZFR5F
14F-9DUO		BCP5ES
14FGH-6DTUR		BKUR7ET
14FGH-7DTURX		BKUR6ET-10
14FGH-8DPURX2		IFR5D10
14FGH-8DTURXO		BKUR5ET
14FGH-8DTURXO		BKUR5ET
14FGR-6DDU		BKR6EKUB
14FGR-7CTU		BCPR7ET
14FLR-8LDUX		BKR5EK
14FR-5DTU		BCPR7ET
14FR-5DU		BCPR7ES
14FR-6DU		BKR6E
14FR-6DUX		BCPR6ES-11
14FR-6LDU3		BKR6EKE
14FR-7DU		BKR6E
14FR-7DUX		BKR6ES-11
14FR-7DUX		BKR6E-11
14FR-7KPU		BKR6EP-8
14FR-7KPUV		BCPR6EP-11
14FR-7KPUX		BCPR6EP-11
14FR-7KU		BKR6EY
14FR-7KUO		BKR6EYA
14FR-7KUOX		BKR6EYA-11
14FR-7LDU		BKR6EKC
14FR-7LUX		ZFR6F-11
14FR-8DU		BKR5E
14FR-8DU		BCPR5ES
14FR-8DUX		BCPR5ES-11
14FR-8HU		BCRE527Y
14FR-8KU		BKR5EY
14FR-8KUO		BKR5EYA
14G-8DTU		BP6ET
14GH-7DTUR		BUR6ET
14GH-8DTUR		BUR5ET
14GH-8DTUREA		BUR5ET
14GH-8DTURX		BUR5ET-10
14GR-8DTU		BPR5EKU
14K-5DU		BP7EFS
14K-5DUO		BP7EFS
14K-6D		BP6EFS
14K-6DU		BP6EFS
14K-6DUO		BP6EFS
14K-7D		BP6EFS
14K-7DU		BP6EFS
14K-7DUO		BP6EFS
14K-8DU		BP5EFS
14K-8DUO		BP5EFS
14K-9DU		BP5EFS
14K-9DUO		BP5EFS
14KGR-6KQU		BUR6EFSZ

BERU	→	NGK
14KR-6BU		BPR6FS
14KR-6DU		BPR6EFS
14KR-6ZPPV		PTR5A-13
14KR-7DUX		BPR6EFS
14KR-8DPUOV		TR55
14KR-8MUV		PTR5A-13
14R-11F		BP4
14R-5DU		BPR7ES
14R-6B		BPR6HS
14R-6BU		BPR6HS
14R-6D		BPR6ES
14R-6DU		BPR6ES
14R-6DUX		BPR6ES-11
14R-6DUX		BUR6EA-11
14R-7B		BPR6HS
14R-7BU		BPR6HS
14R-7CU		BR6ES
14R-7D		BPR6ES
14R-7DU		BPR6ES
14R-7DUX		BPR6EY-11
14R-8DU		BPR5EY
14R-8DUX		BPR5ES-11
14R-9DU		BPR5ES
14R-9DU		GR4
14R-9EUO		BR4LM
14S-5A		BL6H
14S-5F		BPM7A
14S-7A		BL6H
14S-7F		BPM6A
14S-8F		BPM6A
14SR-6F		BPMR6A
14-XAU		B6HS
14Z-2C1		B9EVX
14Z-3A1		B9HS
14Z-3AU		B8HS
14Z-3C1		B9ES
14Z-3CU		B8ES
14Z-4AU		B8HS
14Z-6A2		B6HS
14Z-7AU		B7HS
160/14/3		B6ES
175/14		B6HS
175/14/3		B6ES
175/14/3A		BP6ES
175/14/5		B6S
175/14/5A		BP6S
175/14/5AMX		BPM6A
175/14/UK4		BL6H
175/14A		BP6HS
175/18		A6
175/18K		AP6FS
18-10A		A6



BERU	→ NGK
18-10AU	A6
18-12B	AB2
18-4A1	A7
18-4A2	A7
18-5A	A7
18-5AS	A7
18-5AU	A7
18-7A	A6
18-7AU	A7
18-8A	A6
18K-12B	AP5FS
18K-6BU	AP6FS
18K-7B	AP6FS
18K-7BU	AP6FS
18K-8B	AP5FS
18K-8BU	AP5FS
190/14Z	B6HS
200/14/3	B6ES
200/14/3A	BP6ES
200/14/3K	BP6EFS
200/14A	BP6HS
215/14/3A	BP6ES
225/14	B7HS
225/14/3	B7ES
225/14/3A	BP7ES
225/14/3S	B7ECS
225/14/5	B7S
225/14/5A	BP6S
225/14/5AMX	BPM7A
225/14/UK4	BL6H
225/14A	BP7HS
225/18	A7
225/18S	A7
230/14/3A	BP7ES
235/14/3P	BP7ES
240/14	B7HS
240/14/3	B7ES
240/14A	BP7HS
240/14S	B8HVX
240/18	A7
260/14	B8HS
260/14/3	B8ES
260/14S	B8HVX
260/18	A8
265/14/3P	B8EVX
280/14	B8HS
280/14/3S	B8EVX
280/14/3Z	B9ES
280/14Z	B9HS
310/14/3Z	B9EVX
310/14S	B9HCS
45/18	AP5FS

BERU	→ NGK
95/14	B4H
95/14/3	B4ES
95/14/3A	BP4ES
95/14/5	B4
95/14/5A	BP-4
95/14A	BP4HS
95/18	A6
D 215/14/3 (14/5/C)	B7ES
D175/14	B6HS
D175/14/3	B6ES
D200/14/3A	BP6ES
D215/14/3	BP6ES
D230/14/3A	BP7ES
G 3/18	A9EFP
G 5	---
G 6	---
RS16	BP6HVX
RS18	BP7HVX
RS33	BPR5EVX
RS35	BP6EVX
RS37	BP7EVX
RS39	BP7EVX
Z 1	BP5ES
Z 2	BP5ET
Z 3	ZGR5A
Z 4	ZFR5F
Z 5	BCP5ES
Z 6	BP5EFS
Z 7	BP5EFS
Z 8	BPR5ES
Z 9	BPR5ES-11
Z 10	BP6HS
Z 11	BP6ES
Z 12	BP6ET
Z 13	BKR6E
Z 14	BKR6EK
Z 15	BKR6E
Z 16	BCPR6ES-11
Z 17	BP6EFS
Z 18	BP6EFS
Z 19	BPR6HS
Z 20	BPR6ES
Z 21	BPR6ES-11
Z 22	BP6ES
Z 23	BKR6E
Z 24	BKR6E
Z 25	BP6EFS
Z 26	BPR6EFS
Z 27	BPR6ES
Z 28	BPR6ES-11
Z 29	BCP7ES
Z 30	BCPR7ES



BERU	→ NGK
Z 31	BP7EFS
Z 32	AP6FS
Z 33	AP6FS
Z 35	D7EA
Z 36	D7EA
Z 37	B9HS
Z 38	B9ES
Z 39	B8HS
Z 40	B7HS
Z 41	BP7HS
Z 42	BP7ES
Z 43	BP7ES
Z 44	BP6ET
Z 45	BCPR7ET
Z 46	BP7EFS
Z 47	BPR7ES
Z 48	BP6HS
Z 49	BPR6FS
Z 50	BP6ESZ
Z 51	BP6ET
Z 52	BCP6ET
Z 53	BCP6ET
Z 54	BCP6ES
Z 55	BP6EFS
Z 56	BP6EFS
Z 57	B6HS
Z 58	B6ES
Z 59	BR6ES
Z 60	BCPR7ET
Z 61	BP6ESZ
Z 62	BP6ESZ
Z 63	BCP6ES
Z 64	BCP6ES
Z 66	BP6EFS
Z 67	BPR6EFS-13
Z 68	B5HS
Z 69	BP5ESZ
Z 70	BP5ESZ
Z 71	BCP5ES
Z 72	BCPR5ES
Z 73	BCPR5ES-11
Z 74	BKR5EK
Z 75	BUR5ET
Z 76	BP5ES
Z 77	BP5ESZ
Z 78	BP5ET
Z 79	BCP5ES
Z 80	BP5EFS
Z 81	BP5EFS
Z 82	BPR5ES
Z 83	B4LM
Z 84	BR4LM

BERU	→ NGK
Z 85	B6HS
Z 86	A7
Z 87	A7
Z 88	A6
Z 89	BKUR6ET
Z 90	BKUR6ET-10
Z 91	BUR6ET
Z 92	BUR5ET
Z 93	BUR5ET-10
Z 94	BPR5EKU
Z 95	BPR6EFS
Z 97	PTR5A-13
Z 99	BCPR6ES-11
Z 100	BKR6ES
Z 101	BKR6EK
Z 103	BP7ES
Z 104	BP6ES
Z 105	BKR6E
Z 107	BP4
Z 112	B4
Z 144	BUR6EFSZ
Z 145	BKR6EKUB
Z 148	TR55
Z 149	BCPR6EP-11
Z 150	BCPR6EP-11
Z 151	BKR6EP-8
Z 152	BCRE527Y
Z 153	BKR5EY
Z 154	BKR5EYA
Z 155	BKR6EY
Z 156	BKR6EYA
Z 157	BKR6EYA-11
Z 158	ZFR6F-11

BOSCH	→ NGK
0241235715	PZFR5D-11
0242235642	BKR6EKUB
D10B	AP5FS
D10BC	AP5FS
D6B	AP6FS
D6BC	AP6FS
D6BP	AP6FS
D7A	A6FS
D7AC	A6FS
D7B	AP6FS
D7BC	AP6FS
D7BP	AP6FS
D8A	A5FS
D8AC	A5FS
D8B	AP5FS
D8BC	AP5FS
D8BP	AP5FS



BOSCH	→	NGK
D9B		AP5FS
D9BC		AP5FS
DR10B		APR5FS
DR10BC		APR5FS
DR6BC		APR6FS
DR6BP		APR6FS
DR7BC		APR6FS
DR7BP		APR6FS
DR8B		APR5FS
DR8BC		APR5FS
DR8BP		APR5FS
DR9B		APR5FS
DR9BC		APR5FS
F04DAR		BKR6EK
F09CS		R7115-10
F09CS		R7114-10
F2CS		R7114-9
F3CS		R7114-9
F4CS		R6205-8
F5DC		BCP7ES
F5DP		BCP7ES
F5DPOR		PFR7B
F5DTC		BCP7ET
F6DC		BCP6ES
F6DCO		BCP6ES
F6DCOR		BKR6E
F6DCX		BCP6ES-11
F6DP		BCP6ES
F6DPOR		PFR6Q
F6DPX		BCP6ES-11
F6DSR		BKR6EVX
F6DTC		BCP6ET
F6LTCR		BKUR7ET
F7DC		BCP6ES
F7DCO		BCP6ES
F7DCOR		BKR6E
F7DCX		BCP6ES-11
F7DP		BCP6ES
F7DPP332		IFR6D10
F7DTC		BCP6ET
F7HER2		ZFR5P-G
F7HPP22		BKUR6ET-10 / PFR6Q
F7KTCR		BKUR6ET-10
F7LCOR2		ZFR6F-11
F7LCR		ZFR6A-11
F7LDCR		BKR6EK
F7LTCR		BKUR6ET-10
F8DC		BCP5ES
F8DC4		BCP5ES
F8DCO		BCP5ES
F8DCOR		BCPR5ES
F8DCX		BCP5ES-11

BOSCH	→	NGK
F8DPER		IFR5D10
F8DPP332		IFR5D10
F8KTCR		BKUR5ET
F8LCR		ZFR5F
F8LCR2		ZFR5F
F8LDCR		BKR6EK
F9DCO		BCP4ES
F9LCR		ZFR4F-11
FGR6KOC		BKR6EQUJ
FGR6KQE		BKR6EQUJ
FGR7DQEO		BKR6EKUB
FGR7DQEO		BKR6EKUB
FGR7DQP		BKR6EQUJ
FGR7KOC		BKR6EQUJ
FGR7KQE		BKR6EQUJ
FGR7KQEO		BKR6EQUJ
FGR8MOPE		PLFR5A-11
FLR8LDCU		BKR5EK
F03DAR		BCPR7ER / BKR6EK
FR10DCX		BCPR4ES-11
FR10DX		BCPR4ES-11
FR5DC		BCPR7ES
FR5DCX		BCPR7ES-11
FR5DP		BCPR7ES
FR5DTC		BCPR7ET
FR5LDC		BKR7EKC
FR6DC		BKR6E
FR6DC2 0,7		BKR6E
FR6DCO		BKR6EK
FR6DCX		BCPR6ES-11
FR6DDC		BKR7EKC
FR6DP		BKR6E
FR6DP1X		PFR6J-11
FR6DPX		BCPR6ES-11
FR6DTC		BCPR6ET
FR6DTCW		BKR5EKC
FR6KDC		BKR6EK
FR6KTC		BKUR6ETB
FR6LDC		BKR6EKC
FR6LDC		BKR6EK
FR7DC		BKR6E
FR7DC2		BKR6E
FR7DCO		BKR6E
FR7DCX		BCPR6ES-11
FR7DE		BKR6EZ
FR7DP		BKR6E
FR7DP1X		PFR6B-11
FR7DPP10		BKR6EVX
FR7DPX		BCPR6ES-11
FR7DTC		BCPR6ET
FR7KCW		BKR6EP-13
FR7KDC		BKR6EK



BOSCH	→	NGK
FR7LC2		BKR6E
FR7LCX		ZFR6F-11
FR7LDC		BKR6EK
FR8DC		BKR5ES
FR8DCO		BKR5ES
FR8DCX		BKR5ES-11
FR8DPX		BKR5ES-11
FR8DS		BKR5EVX
FR8DX		BKR5ES-11
FR8HP		ZFR5F-11
FR8KCU		BKR5EYA-11
FR8LCX		ZFR6F-11
FR8LDC		BKR5EK
FR8LDC4		BKR5EK
FR8ME		LF5B
FR9DCX		BCPR4ES-11
FR9HC		ZFR4F-11
H10B		BP4FS
H10BC		BP4FS
H2CS		B9EFS
H3CS		B8EFS
H5D		BP7EFS
H5DC		BP7EFS
H5DCO		BP7EFS
H5DP		BP7EFS
H6B		BP6FS
H6BC		BP6FS
H6D		BP6EFS
H6DC		BP6EFS
H6DCO		BP6EFS
H6DP		BP6EFS
H7CC		B6EFS
H7CP		B6EFS
H7D		BP6EFS
H7DC		BP6EFS
H7DCO		BP6EFS
H7DCY		BP6EFS-13
H7DP		BP6EFS
H7DPY		BP6EFS-13
H8B		BP5FS
H8BC		BP5FS
H8BP		BP5FS
H8DC		BP5EFS
H8DCO		BP5EFS
H8DCX		BP5EFS-13
H8DP		BP5EFS
H9B		BP4FS
H9BC		BP4FS
H9BCY		BPR4FS-15
H9DC		BP5EFS
H9DCO		BP5EFS
H9HP		BP5EFS

BOSCH	→	NGK
HGR6KOC		BUR6EFSZ
HGR7KOC		BUR6EFSZ
HR10A		BR5FS
HR10AC		BR5FS
HR10ACY		BR5FS-15
HR10AY		BR5FS-15
HR10B		BPR4FS
HR10BC		BPR4FS
HR10BCX		BPR4FS-11
HR10BCY		BPR4FS-15
HR10BX		BPR4FS-11
HR10BY		BPR4FS-15
HR6B		BPR6FS
HR6BC		BPR6FS
HR6BP		BPR6FS
HR6D		BPR6EFS
HR6DC		BPR6EFS
HR6DP		BPR6EFS
HR6DS		BPR6EFS
HR7DC		BPR6EFS
HR7MPP		PTR5A-13
HR8A		BR5FS
HR8AC		BR5FS
HR8ACY		BR5FS-15
HR8AP		BR5FS
HR8APY		BR5FS-15
HR8AY		BR5FS-15
HR8B		BPR5FS
HR8BC		BPR5FS
HR8BCY		BPR5FS-15
HR8BP		BPR5FS
HR8BPX		BPR5FS-11
HR8BPY		BPR5FS-15
HR8BY		BPR5FS-15
HR8LCO		TR5-1/SR5
HR8LPO		TR5-1/SR5
HR9A		BR5FS
HR9AC		BR5FS
HR9ACY		BR5FS-15
HR9AP		BR5FS
HR9APY		BR5FS-15
HR9AY		BR5FS-15
HR9B		BPR4FS
HR9BC		BPR4FS
HR9BCY		BPR4FS-15
HR9BPX		BPR4FS-11
HR9BPY		BPR4FS-15
HR9BY		BPR4FS-15
HR9D		BPR5EFS
HR9DC		BPR5EFS
HR9DCX		BPR5EFS-13
HS5E		BM7F



BOSCH	→	NGK
HS8E		BM6F
M10A		A6
M10AC		A6
M10ACO		A6
M10AO		A6
M12B		A6
M145T1		A6
M145T5		A6
M175T1		A6
M225T1		A7
M240T1		A7
M280T1		A8
M45T1		A6
M4A		A7
M4A1		A8
M4A2		A7
M4AC		A7
M5A		A7
M5AC		A7
M7A		A6
M7AC		A7
M8A		A6
M8AC		A6
M8AO		A6
M95T1		A6
M95T5		A6
MA145T1		A5FS
MA145T7		AP5FS
MA145TR7		APR5FS
MA175T1		A6FS
MA175T7		AP6FS
MA200T7		AP6FS
UR2AS		CR8HS
UR3AS		CR7HS
UR4AS		CR6HS
W06AS		B10HVX
W06CS		B11EGV
W07AS		B10HVX
W07CS		B10EGV
W08AS		B9HVX
W08CS		B10EGV
W10A		B4H
W10AC		B4H
W10C		B4ES
W10CC		B4ES
W10D		BP4ES
W10DC		BP4ES
W10E		B4
W10F		BP4
W10FC		BP4
W125T1		B4H
W125T2		B4ES

BOSCH	→	NGK
W125T3		B4
W125T30		BP5ES
W125T4		B4H
W125TR2		BR5ES
W125TR3		BR6S
W125TR30		BPR5ES
W12A		B4H
W12E		B2
W145T1		B5HS
W145T1.1		B5HS
W145T2		B5ES
W145T3		B6S
W145T30		BP5ES
W145T35		BP5HS
W145TR2		BR5ES
W145TR3		BR6S
W145TR30		BPR5ES
W175T1		B6HS
W175T2		B6ES
W175T3		B6S
W175T30		BP6ES
W175T35		BP6HS
W175T6		BP6S
W175T7		BP6HS
W175TR1		BR6HS
W175TR30		BPR6ES
W175Z1		B6HS
W190M11S		B6HVX
W200T27		BP6ES
W200T30		BP6ES
W200T35		BP6HS
W200TR30		BPR6ES
W215P21		BP7EVX / BPR7EIX
W215T30		BP6ES
W225T1		B7HS
W225T2		B7ES
W225T3		B7S
W225T35		BP7HS
W225TR30		BPR7ES
W230T30		BP7ES
W240M1		B8HS
W240M21		B8HS
W240T1		B8HS
W240T2		B8ES
W240T3		B7S
W250P21		BP7ES
W250T1		B8HS
W250T2		B8ES
W255T30		BP7ES
W260M1		B8HS
W260MZ1		B8HS
W260MZ2		B9ES



BOSCH	→	NGK
W260S1S		B8HVX
W260S2S		B8EVX
W260T1		B8HS
W260T2		B9ES
W260T20		B8ES
W275T1		B8HS
W275T2		B9ES
W280MZ1		B8HS
W280MZ2		B9ES
W280S1S		B9HVX
W280S2S		B9EVX
W280T30		BP8ES
W2A		B9HS
W2AC		B9HS
W2AS		B9HVX
W2C		B10ES
W2CC		B10ES
W2CO		B10ES
W2CS		B10EVX
W2D		BP9ES
W300MZ2		B10ES
W300T1		B9HS
W300T2		B10ES
W300T30		BP9ES
W310S1S		B9HVX
W310S2S		B10EVX
W3A		B8HS
W3AC		B8HS
W3AO		B8HS
W3AP		B8HS
W3AS		B8HVX
W3C		B9ES
W3CC		B9ES
W3CO		B9ES
W3CP		B9ES
W3CS		B9EVX
W3D		BP8ES
W3DP		BP8EVX
W3DP2		BP8ES
W3DPO		BP8EVX
W45T1		B4H
W4A		B8HS
W4A1		B8HS
W4A2		B8HS
W4A5		B8HS
W4AC		B8HS
W4AP		B8HS
W4AS		B8HVX
W4C		B8ES
W4C1		B8ES
W4C2		B7ES
W4C3		B7HS

BOSCH	→	NGK
W4CC		B8ES
W4CP		B8EVX
W4CPX		B8ES-11
W4CS		B8EVX
W4DP		BP7EVX
W4DPO		BP7EVX / PFR7B
W4E2		B7S
W5A		B7HS
W5AC		B7HS
W5AP		B7HS
W5AS		B7HVX
W5B		BP7HS
W5BC		BP7HS
W5BP		BP7HS
W5C		B7ES
W5CC		B7ES
W5CCX		B7ES-11
W5CP		B7ES
W5CPX		B7ES-11
W5CS		B7EVX
W5D		BP7ES
W5D1		BP7ES
W5DC		BP7ES
W5DCO		BP7ES
W5DCX		BP7ES-11
W5DP		BP7ES
W5DPO		BP7EVX
W5DPX		BP7ES-11
W5DTC		BP6ET
W5E		B7S
W5EC		B7S
W5EP		B7S
W6AS		B6HVX
W6B		BP6HS
W6BC		BP6HS
W6BP		BP6HS
W6D		BP6ES
W6D1		BP6ES
W6DC		BP6ES
W6DC 0,8		BP6ES
W6DCO		BP6ES
W6DCO 0,8		BP6ESZ
W6DCX		BP6ES-11
W6DP		BP6EVX
W6DPO		BP6EVX
W6DPX		BP6EVX (1,1)
W6DTC		BP6ET
W7A		B6HS
W7AC		B6HS
W7AO		B6HS
W7AP		B6HS
W7B		BP6HS



BOSCH	→	NGK
W7BC		BP6HS
W7BP		BP6HS
W7C		B6ES
W7CC		B6ES
W7CCO		B6ES
W7CCX		B6ES-11
W7CP		B6ES
W7CPX		B6ES-11
W7CX		B6ES-11
W7D		BP6ES
W7DO		BP6ES
W7DC		BP6ES
W7DCO		BP6ESZ
W7DCR		BPR6ES
W7DCX		BP6ES-11
W7DO		BP6ES
W7DP		BP6ES
W7DPX		BP6ES-11
W7DTC		BP6ET
W7DTC 1,0		BP6ET
W7DX		BP6ES-11
W7E		B6S
W7EC		B6S
W7EP		B6S
W7F		BP6S
W7FC		BP6S
W7LTCR		BUR6ET
W8A		B5HS
W8AC		B5HS
W8AO		B5HS
W8AP		B5HS
W8B		BP5HS
W8BC		BP5HS
W8BP		BP5HS
W8C		B5ES
W8CC		B5ES
W8CCX		B5ES-11
W8CO		B5ES
W8CP		B5ES
W8D		BP5ES
W8DC		BP5ES
W8DCO		BP5ES
W8DCX		BP5ES-11
W8DCY		BP5ES-13
W8DP		BP5ES
W8DPX		BP5ES-11
W8DTC		BP5ET
W8DX		BP5ES-11
W8E		B6S
W8EC		B6S
W8F		BP5S
W8FC		BP5S

BOSCH	→	NGK
W8LCR		ZGR5A
W8LDCR		BUR6ET
W8LPR		ZGR5A
W8LTCR		BUR5ET/BPR5EKU
W8LTCR 1,0		BUR5ET-10
W8LTCREA		BUR5ET
W95T1		B4H
W95T2		B4ES
W95T3		B4
W95T30		BP4ES
W95T6		BP4
W9A		B4H
W9AC		B5HS
W9ACO		B5HS
W9AO		B4H
W9C		B4ES
W9CC		B4ES
W9D		BP5ES
W9DC		BP5ES
W9DCX		BP5ES-11
W9DP		BP5ES
W9DPX		BP5ES-11
W9DTC		BP5ET
W9E		B4
W9EC		B4
W9ECO		B4LM
W9EO		B4LM
W9F		BP5S
W9FC		BP5S
W9LC		ZGR5A
WA125TR30		BPR5EFS
WA200T30		BP6EFS
WA200TR30		BPR6EFS
WA225T30		BP7EFS
WAK145T3		BM6F
WAK225T3		BM7F
WEA		BUH
WEC		BUE
WET1		BUH
WET2		BUE
WKA145T3		BM6A
WKA145T6		BPM6A
WKA175T3		BM6A
WKA175T6		BPM6A
WKA200TR6		BPMR6A
WKA225T3		BM7A
WKA225T6		BPM7A
WQ6CS		B11EGV
WR10A		BR4HS
WR10AC		BR4HS
WR10E		BR6S
WR10F		BP4



BOSCH	→	NGK
WR10FC		BP4
WR10FCY		BPR4S-15
WR10FY		BPR4S-15
WR10LCV		BPR4ES-13
WR11EO		BR4LM
WR4AC		BR8HS
WR4CC		BR8ES
WR4CP		BR8EVX
WR5A		BR7HS
WR5AC		BR7HS
WR5CC		BR7ES
WR5CP		BR7ES
WR5D		BPR7ES
WR5DC		BPR7ES
WR5DP		BPR7ES
WR5DS		BPR7EVX
WR6D		BPR6ES
WR6DC		BPR6ES
WR6DCX		BPR6ES-11
WR6DP		BPR6ES
WR6DPX		BPR6ES-11
WR6DS		BPR6EVX
WR6DTC		BP6ET
WR6DTC		BUR6ETB-10
WR7A		BR6HS
WR7AC		BR6HS
WR7B		BPR6HS
WR7BC		BPR6HS
WR7BP		BPR6HS
WR7C		BR6ES
WR7CC		BR6ES
WR7CCX		BR6ES-11
WR7CP		BR6ES
WR7CPX		BR6ES-11
WR7D		BPR6ES
WR7DC		BPR6ES
WR7DCX		BPR6ES-11
WR7DP		BPR6EVX
WR7DS		BPR6ES
WR7F		BPR6S
WR7F		BP6S
WR8AC		BR5HS
WR8C		BR5ES
WR8CC		BR5ES
WR8CP		BR5ES
WR8D		BPR5ES
WR8DC		BPR5ES
WR8DCO		BPR5ES
WR8DCX		BPR5ES-11
WR8DP		BPR5ES
WR8DPX		BPR5ES-11
WR8DPY		BPR5ES-15

BOSCH	→	NGK
WR8DS		BPR5EVX
WR8E		BR6S
WR8EC		BR6S
WR8EP		BR6S
WR8F		BPR5S
WR8F		BP5S
WR8FC		BP5S
WR8FC		BPR5S
WR8FP		BPR5S
WR8FP		BP5S
WR8FPY		BPR5S-15
WR8HP		ZGR5C
WR9AO		BR5HS
WR9C		BR5ES
WR9CC		BR5ES
WR9D		BPR5ES
WR9DC		BPR5ES
WR9DCY		BPR5ES-15
WR9DP		BPR5ES
WR9DPX		BPR5ES-11
WR9DS		BPR5EVX
WR9DY		BPR5ES-15
WR9E		BR6S
WR9EC		BR6S
WR9ECO		BR6S / BM6
WR9EO		BR6S
WR9F		BPR5S
WR9F		BP5S
WR9FC		BP5S
WR9FC		BPR5S
WR9FCY		BPR5S-15
WR9FP		BP5S
WR9FPY		BPR5S-15
WR9FY		BPR5S-15
WR9HC		ZGR5C
WR9HP		ZGR5C
WR9LS		ZGR5A
WR55F		BPMR7A
WS5E		BM7A
WS5F		BPM7A
WS7E		BM6A
WS7F		BPM6A
WS8E		BM6A
WS8F		BPM6A
WSR5F		BPMR7A
WSR6F		BPMR6A
WSR8F		BPMR6A
WSR9E		BMR4A
X3CPO		D9EA
X4CS		D8EA
X5DC		D7EA
XR2AS		DR8HS



BOSCH	→	NGK
XR2CS		DR8ES
XR4AS		DR8HS
XR4CS		DR8ES
XR5DC		DR7EA
Y6DC		---
YR7DE		DCPR8EN
ZR8TPP15		LF85B
BRISK	→	NGK
B12YC		DP9EA-9
B14YC		DP8EA-9
B15YC		DP7EA-9
D12YC		BCP7ES
D14Y		BKR6E
D14YC		BCP7ES
D15Y		BKR6E
D15YC		BCP6ES
D17Y		BKR5E
D17YC		BCP5ES
DR12YC		BKR7E
DR12ZC-1		---
DR14YC		BCPR7ES
DR14ZC		ZFR7F-11
DR14ZC-1		BCPR7ES-11
DR15TC		BKUR5ET-10
DR15YC		BKR6E
DR15Z		BKR6E
DR15Z-1		BCPR6ES-11
DR17YC		BCPR5ES
F14YC		AP7FS
F15YC		AP6FS
FR14YC		APR6FS
FR15YC		APR6FS
G12YC		BP7EFS
G14Y		BP7EFS
G14YC		BP7EFS
G15Y		BP6EFS
G15YC		BP6EFS
G17Y		BP5EFS
G17YC		BP5EFS
GR12YC		BPR7EFS
GR14YC		BPR7EFS
GR15YC		BPR6EFS
GR17YC		BPR5EFS
J17		B4LM
J19		B2LM
JR17		BR4LM
JR19		BR2LM
K15YC		BP6S
K17C		B6S
K17Y		BP5S
K19		B4

BRISK	→	NGK
L08JW		B10EGV
L08W		B11EGV
L10JW		B8EGV
L12W		B9EVX
L12Y		BP9ES
L12YC		BP9ES
L14		B8ES
L14C		B8ES
L14Y		BP6ES
L14YC		BP7ES
L15		B7ES
L15C		B7ES
L15W		B8EVX
L15Y		BP6ES
L15YC		BP6ES
L17		B6ES
L17C		B6ES
L17W		B7EVX
L17Y		BP5ES
L17YC		BP5ES
L19		B4E
L19C		B5E
LR12YC		BPR8ES
LR12ZC		BPR8ES
LR12ZC-1		---
LR14TXS		BUR6ET
LR14YC		BPR7ES
LR14ZC		BPR7ES
LR14ZC-1		BPR7ES-11
LR15TXS		BP5ET
LR15YC		BPR6ES
LR15Z		BPR6ES
LR15Z-1		BPR6ES-11
LR17YC		BPR5ES
N08W		B10HVX
N12W		B9HVX
N12Y		BP8HS
N12YC		BP8HS
N14		B8HS
N14C		B9HS
N14Y		BP6HS
N14YC		BP7HS
N15		B6HS
N15C		B7HS
N15W		B8HVX
N15Y		BP6HS
N15YC		BP6HS
N17		B5HS
N17C		B6HS
N17W		B7HVX
N17Y		BP4HS
N17YC		BP5HS



BRISK	→	NGK
N19		B5HS
N19C		B5HS
NR12YC		BPR8HS
NR15YC		BPR6HS
P15		BM7A
P15Y		BPM7A
P17		BM6A
P17Y		BPM6A
PR15Y		BPMR7A
PR17Y		BPMR6A
U15		BM7F
U17		BM6F
CHAMPION → NGK		
5828 / QL77JC4		BZ7HS-10
5838 / QL78V		BUZHWH-2
5883 / QL78C		BR7HS
5898 / QL76V		BUZHWH
5931 / RL82C		BR6HS
5933 / L86CC		B6HS
5939 / QL78YC		BPR7HS
5942 / RV15YC4		BPR4FS-11
860		A6FS
870		A5FS
A10		D7EA
A4HC		DP9EA-9
A50R		R2525-11
A50R		R2198-12P
A51R		R2525-10
A51R		R2198-11P
A53C		R2525-11
A53R		R2525-11
A53R		R2198-10P
A55C		R2525-10
A55R		R2525-10
A55V		R2270-11
A57C		R2525-10
A57G		R2525-10
A57R		R2525-10
A59C		D9EA
A59C		R2525-9
A59G		D9EVX
A59G		R2525-9
A59GC		R2430-9 (Ducati)
A59GC		DCPR9EVX
A5YC		DP9EA-9
A6		D8EA
A61		D9EA
A61G		D9EVX
A6G		D8EVX
A6GC		D8EVX
A6HC		DP8EA-9

CHAMPION	→	NGK
A6Y		DP8EA-9
A6YC		DP8EA-9
A8		D7EA
A8Y		DP7EA-9
A8YC		DP7EA-9
BL11Y		BP5FS
BL13Y		BP5FS
BL4		B7FS
BL5		B7FS
BL6		B6FS
BL7Y		BP7FS
BL8		B6FS
BL9Y		BP6FS
BN12Y		BP5EFS
BN2		B9EFS
BN6Y		BP7EFS
BN7Y		BP6EFS
BN89Y		BP6EFS
BN9Y		BP6EFS
C10YCC		BCP6ES
C10YCC		BCP5ES
C11YCC		BCP5ES
C281YC		BCP6ES
C55		R7234-10
C55 R		R7234-10
C57		R7234-9
C57C		R7234-9
C59		R7234-9
C59C		R7234-9
C59YC		R5672A-9
C61		R7234-8
C6BYC		BCP7ET
C6VPYC		BKR7EVX-11
C6YCC		BCP7ES
C7Y		BCP7ES
C7YC		BCP7ES
C7YCC		BCP7ES
C7YCX		BCP7ES
C9MCC		ZFR5F
C9Y		BCP6ES
C9YC		BCP6ES
C9YCC		BCP6ES
C9YCX		BCP6ES
CJ11		BM6A
CJ14		BM4A
CJ17LM		B4LM
CJ3		BM7A
CJ4		BM7A
CJ6		BM7A
CJ6Y		BPM7A
CJ7Y		BPM7A
CJ8		BM6A



CHAMPION	→	NGK
CJ86		BM6A
CJ8Y		BPM6A
D10		A6
D14		A6
D16		A6
D16J		A6
D21		A6
D6		A8
D9		A6
D9J		A6
DJ6J		BM7F
DJ6Y		BPM7F
DJ7J		BM6F
DJ7Y		BPM6F
DJ8J		BM6F
F10		A6FS
F10C		A6FS
F11Y		AP5FS
F11YC		AP5FS
F14Y		AP5FS
F62Y		AP8FS
F7Y		AP7FS
F7YC		AP7FS
F7YCC		AP7FS
F81Y		AP8FS
F-82		A8F
F83Y		AP8FS
F9Y		AP6FS
F9YC		AP6FS
FN507Y		BCP7ES
G 56 R		R 016-10
G 63 R		R 016-8
G1		C9E
G2		C8E
G54V		R0045J-10
G55		C9E
G58		C9E
G59C		C7E
G61		C8E
G63		C8E
H03		B6S
H10		B6L
H10C		B6L
H10J		B6L
H11		B4L
H12		B4L
H8		B6L
H8C		B6L
H8J		B6L
J10Y		BP6S
J11		B4
J11C		B4

CHAMPION	→	NGK
J11J		B4
J11Y		BP5S
J12J		B2
J12Y		BP5S
J12YC		BP5S
J13Y		BP5S
J14J		B2
J14Y		BP5S
J14YC		BP5S
J17LM		B4LM
J18Y		BP4
J18YC		BP4
J19LM		B2LM
J2J		B9S
J4		B7S
J4C		B7S
J4J		B7S
J5		B7S
J6		B6S
J6C		B6S
J6J		B6S
J7		B6S
J7J		B6S
J8		B6S
J8C		B6S
J8J		B6S
K13		A6
K15J		A6
K3G		A8
K5G		A8
K7		A8
K-8		A8
K8G		A8
K9		A7
L10		B6HS
L12Y		BP5HS
L14		B4H
L15Y		BP4HS
L19V		BUH
L20V		BUH
L288		B5HS
L2G		B9HVX
L3G		B8HVX
L4G		B7HVX
L4J		B7HS
L5		B7HS
L55G		B10HVX
L61Y		BP8HS
L64Y		BP7HS
L66Y		BP6HS
L6G		B7HVX
L6VC		BU8H



CHAMPION	→	NGK
L76V		BUHW
L77J		B7HS
L77JA		B7HS-10
L77JC		B7HS
L77JCA		B7HS-10
L77V		BUHW
L78		B7HS
L78C		B7HS
L78V		BUHW-2
L78YC		BP7HS-10
L78YC6		BP8HS-15
L7J		B6HS
L81		B7HS
L81Y		BP7HS
L82		B6HS
L82C		B6HS
L82Y		BP6HS
L82YC		BP6HS
L82YCC		BP6HS
L85		B6HS
L85Y		BP6HS
L86		B6HS
L86C		B6HS
L86CC		B6HS
L87Y		BP6HS
L87YC		BP6HS
L87YCC		BP6HS
L89CM		BP5HS
L90		B5HS
L90C		B5HS
L92LCC		BP5HA
L92Y		BP5HS
L92YC		BP5HS
L95Y		BP4HS
L9G		B6HVX
L9J		B6HS
N1		B10ES
N10PY		BP6EVX
N10Y		BP6ES
N10Y4		BP6ES-11
N11Y		BP5ES
N11YC		BP5ES
N11YCA		BP5ES-11
N11YCC		BP5ES
N12Y		BP5ES
N12YC		BP5ES
N12YCC		BP5ES
N13L		ZGR5C
N13Y		BP5ES
N14LY		ZGR5C
N14Y		BP5ES
N16Y		BP4ES

CHAMPION	→	NGK
N16YC		BP4ES
N178B		B8EM
N180B		B7EM
N19V		BUE
N1C		B10ES
N2		B9ES
N21		B4ES
N279YC		BP7ES
N281YC		BP6ES
N288		B5ES
N2C		B9ES
N2G		B9EVX
N3		B8ES
N3C		B8ES
N3G		B8EVX
N4		B7ES
N4C		B7ES
N4G		B7EVX
N4YC		BP9ES
N5		B6ES
N52R		-----
N54R		B10EG
N55G		B10SEGV
N56R		B10SEGP
N57		B10ES
N57G		B10SEGV
N57R		B10EG
N59G		B95EGV
N5C		B6ES
N5G		B6EVX
N6		B6ES
N60		B9ES
N60R		B8EG
N60Y		BPR10EVX
N62R		B8EG
N63Y		BP9ES
N64Y		BP8ES
N65Y		BP7ES
N66Y		BP6ES
N6BYC		BP6ET
N6GY		BP8EVX
N6Y		BP8ES
N6YC		BP8ES
N6YCC		BP8ES
N7		B7ES
N74C		BUR6EB-11/B6EB-11
N79Y		BP6ES
N7BMC		BP6ET
N7BYC		BP6ET
N7GY		BP7EVX
N7Y		BP7ES
N7YC		BP7ES



CHAMPION	→	NGK
N7YCC		BP7ES
N7YCX		BP7ES
N8		B6ES
N80		B10EG
N80G		B11EGV
N82		B10EG
N82G		B10SEGV
N84		B9EG
N84G		B9SEGV
N86		B9EG
N86G		B9EGV
N87		B8EG
N87G		B8EGV
N8GY		BP6EVX
N8L		ZGR5C
N8Y		BP6ES
N9BMC		BPR5EKU
N9BYC		BP6ET
N9BYC4		BP5ET-10
N9Y		BP6ES
N9YC		BP6ES
N9YC4		BP6ES-11
N9YCC		BP6ES
N9YCX		BP6ES
OBL9Y		BPR6FS
OJ11Y		BP6S
OJ12Y		BP5S
OJ13Y		BP5S
ON11Y		BPR5ES
ON12Y		BPR5ES
ON3		BR8ES
P10Y		D6HA
P7		D8HA
P7G		DR8HS
P8Y		D6HA
PG2PHP		PMR8A
PG4PHP		PMR7A
PZ7HC		C7HSA
QC12PEP		PZFR6H
QC12YC		BKR5ES
QL16V		BUZ8H
QL6VC		BU8H
QL76V		BUZHW
QL77CC		BR8HS
QL77J4		BZ7HS-10
QL77JC4		BZ7HS-10
QL78C		BR7HS
QL78V		BUZHW-2
QL78YC		BPR7HS
QL7J5		BR6HS
QL81Y		BPZ7HS-10
QL82C		BR6HS

CHAMPION	→	NGK
QL82YC		BPR6HS
QL86		BR6HS
QL87YC		BPR6HS
QL92LCC		BPR8HS-10
QN2		BR9ES
QN2C		BR9ES
QN2G		BR9EVX
QN3		BR8ES
QN3C		BR8ES
QN84		BR9EG
QN86		BR8EG
R10		D6EA
R54G		R 217-11
R6		D8EA
R6G		D8EVX
R8		D7EA
RA2HC		DPR9EA-9
RA4HC		DCPR9E
RA4HC		DPR9EA-9
RA4HCC		DCPR8E
RA59GC		DCPR9EVX
RA59PP		D9EVX
RA6		DR8ESL
RA6HC		DCPR8E
RA6HC		DPR8EA-9
RA6Y		DPR8EA-9
RA6YC		DPR8EA-9
RA8HC		DCPR7E
RA8Y		DPR7EA-9
RA8YC		DPR7EA-9
RBL11Y		BPR5FS
RBL11Y6		BPR5FS-15
RBL12		BR5FS
RBL12-6		BR5FS-15
RBL13Y		BPR5FS
RBL13Y6		BPR5FS-15
RBL15Y		BPR4FS
RBL15Y4		BPR4FS-11
RBL15Y6		BPR4FS-15
RBL16Y		BPR4FS
RBL17Y		BPR4FS
RBL17Y6		BPR4FS-15
RBL8		BR6FS
RBL8-6		BR6FS-15
RBL9Y		BPR6FS
RBN12Y		BPR5EFS
RBN13Y		BPR5EFS
RBN14Y		BPR5EFS
RBN9Y		BPR6EFS
RC10DMC		BKR5EK
RC10ECC		ZFR6F-11
RC10PYC		BKR6EVX 0,8



CHAMPION	→ NGK
RC10PYP4	PFR5G
RC10PYP4	PFR5J-11
RC10VTYC4	BPR5EKUP
RC10YC4	BCPR6ES-11
RC10YCC	BKR6E
RC11LCC4	BRE527Y-11
RC12LYC	ZFR5F
RC12MC4	PZFR5F-11
RC12MC5	ZFR5F-11
RC12PYP	PFR5J-11
RC12YC	BKR5ES
RC12YC5	FR45
RC14YC	BKR5ES
RC14YC4	BKR5E-11
RC6VPYC	BKR7EVX-11
RC6YC	BCPR7ES
RC7BMC	BCPR6ET
RC7BYC4	BCPR6ET
RC7GYC	BKR7EVX-11
RC7Y	BCPR7ES
RC7YC	BCPR7ES
RC7YC4	BKR7ES-11
RC7YCC	BCPR7ES
RC7YCC4	BKR7ES-11
RC87PYC	BKUR6ET-10
RC87YCL	PFR6G-9
RC87YCL	BKR6EZ
RC89PYC	BKUR5ET-10
RC89YCC	BKR5EZ
RC8BYC	BKR6EKC
RC8DMC	BKR6EK
RC8PYCB	PFR6G-9
RC8PYP	PFR6J-11
RC8PYPB4	PFR5G-13E
RC8PYX	FR7KDC
RC8VTYC4	BKUR6ET-10
RC8VTYC4	BUR6ET-10
RC8YC4	BKR5E-11
RC8YCL	BKR6ES
RC9BMC	BKR5EKU
RC9MC4	ZFR5F-11
RC9MCC	ZFR6F
RC9Y	BKR6E
RC9YC	BKR6E
RC9YC4	BCPR6ES-11
RC9YCC	BKR6E
RCJ4	BMR7A
RCJ6	BMR7A
RCJ6Y	BPMR7A
RCJ7Y	BPMR7A
RCJB	BMR6A
RCJBY	BPMR6A

CHAMPION	→ NGK
RD14	A6
RD16	A6
RD16J	A6
RD9	A6
RDJ6J	BM7F
RDJ7J	BMR6F
RDJ7Y	BPMR6F
RDJ8J	BMR6F
RE10LC	SR5
RE14MCC5	LZTR4A-11
RE7PYC5	PTR5A-13
RE7YCC	PTR5A-13
REABMCL	LZKAR7A
REC10PYC4	LFTR5AP-11
REC9YCL	LFTR5B
RES9YCC4	PTR5A-13
RF10	AR6FS
RF10C	AR6FS
RF11Y	APR6FS
RF11YC	APR6FS
RF11YC	WR5
RF12-5	AR5FS-11
RF14Y	APR5FS
RF7YC	APR6FS
RF7YCC	APR6FS
RF9Y	APR6FS
RF9Y5	APR6FS
RF9YC	APR6FS
RF9YC	WR5
RFN14LY	ZFR4F-11
RG2PHP	CR8EVX
RG4HC	CR9E
RG4PHP	PMR7A
RG4PHP	PMR8A
RG6YC	CR8EB
RG6YCH	CPR8E
RG94C	CR8E
RH10C	B6L
RH10C	B6L
RH8C	----
RJ10Y	BP6S
RJ11	BR6S
RJ11Y	BP5S
RJ12C	BR6S
RJ12Y	BP5S
RJ12YC	XR5
RJ12YC	BP5S
RJ14CC	XR4
RJ14Y	BP5S
RJ14YC	XR4
RJ14YC	BP5S



CHAMPION	→ NGK
RJ14YC	XR4
RJ17LM	BR4LM
RJ18Y	BP4
RJ18YC	BP4
RJ18YC	XR4
RJ19LM	BR2LM
RJ20Y	BP4
RJ6	BR6S
RJ6C	BR6S
RJ6J	BR6S
RJ7	BR6S
RJ8	BR6S
RJ8C	BR6S
RJ8J	BR6S
RL12Y	BPR6HS
RL19	BR5HS
RL4J	BR7HS
RL77J	BR7HS
RL78	BR7HS
RL78C	BR7HS
RL7J	BR6HS
RL82	BR6HS
RL82C	BR6HS
RL82Y	BPR6HS
RL82YC	BPR6HS
RL82YCC	BPR6HS
RL85	BR6HS
RL85G	---
RL86	BR6HS
RL86C	BR6HS
RL87Y	BPR6HS
RL87YC	BPR6HS
RL90	BR5HS
RL95YC	BPR5HS
RN10GY	BPR6EVX
RN10VTYC	BUR5ET
RN10VTYC4	BUR5ET-10
RN10Y	BPR6ES
RN10Y4	BPR6ES-11
RN11Y	BPR5ES
RN11YC	BPR5ES
RN11YC4	BPR5ES-11
RN11YCC	BPR5ES
RN12GY	BPR5EVX
RN12MC4	BPR4EY-11
RN12Y	BPR5ES
RN12YC	BPR5ES
RN12YC4	BPR5ES-11
RN12YC6	BPR5ES-13
RN12YCC	BPR5ES
RN13L	ZGR5C
RN13LYC	ZGR5C

CHAMPION	→ NGK
RN14LY	ZGR5C
RN14MC5	BPR4EY-11
RN14PMP5	GR4
RN14Y	BPR5ES
RN14Y6	BPR5ES-13
RN14YC	GR4
RN16Y	BPR4ES
RN16YC5	BPR4ES-13
RN180B	BR7EM
RN1C	BR10ES
RN2	BR9ES
RN2C	BR9ES
RN2G	BR9EVX
RN3	BR8ES
RN3C	BR8ES
RN3G	BR8EVX
RN4	BR7ES
RN49G	---
RN4C	BR7ES
RN5	BR6ES
RN57YC	BR10EG
RN5C	BR6ES
RN6	BR6ES
RN6Y	BPR8ES
RN6YC	BPR8ES
RN74C	BR6EB-11
RN79G	---
RN7GY	BPR7EVX
RN7Y	BPR7ES
RN7YC	BPR7ES
RN7YCC	BPR7ES
RN7YCC4	BPR7ES-11
RN8	BR5ES
RN8L	ZGR5C
RN8VTYC4	BUR6ET
RN9GY	BPR6EVX
RN9LCC	ZGR5B
RN9Y	BPR6ES
RN9YC	GR5
RN9YC	BPR6ES
RN9YC4	BPR6ES-11
RN9YCC	BPR6ES
RN9YCC	GR5
RP10HC	DR5HS
RP7	DR8HS
RS10LC	TR5-1
RS12YC	TR4
RS12YC	BPR5EFS
RS12YC6	BPR5EFS-13
RS13LYC	TR4-2
RS14LC	TR5-1



CHAMPION	→	NGK
RS14LYC		TR4-2
RS14YC		BPR5EFS
RS15LYC		TR4-2
RS17YX		TR4
RS5C		BR7EFS
RS7YC		BPR7EFS
RS9YC		BPR6EFS
RS9YCC		BPR6EFS
RV12C		BR5FS
RV12C6		BR5FS-15
RV12YC		BPR5FS
RV12YC		UR5
RV12YC6		BPR5FS-15
RV15YC		BPR4FS
RV15YC4		UR4
RV15YC4		BPR4FS-11
RV15YC6		BPR4FS-15
RV17YC		BPR4FS
RV17YC6		BPR4FS-15
RV8C		BR6FS
RV8C6		BR6FS-15
RV91MC		BR6FS
RV92YC		BPR5FS
RV9YC		BPR6FS
RV9YC		UR6
RZ7C		CMR7H
RZN12Y		BPR5EFS
RZN12Y5		BPR5EFS
S10YCC		BP5EFS
S12YC		BP5EFS
S279YC		BP6EFS
S281YC		BP6EFS
S379YC		BP7EFS
S59C		R5724-9
S6YC		BP7EFS
S7YC		BP7EFS
S7YCC		BP7EFS
S9YC		BP6EFS
S9YCC		BP6EFS
UD16		A6
UJ12		B2
UJ2J		B8S
UJ4J		B7S
UJ6		B6S
UJ8		B6S
UJ81C		B7S
UJ81J		B7S
UK10		A6
UL17V		BUHXW-1
UL18V		BUHX
UL4J		B7HS
UL77V		BUHXW-1

CHAMPION	→	NGK
UL81C		B7HS
UL81J		B7HS
UN19V		BUE
UN79Y		BP6ES
UY6		---
V12YC		BP5FS
V4C		B7FS
V63C		R5673-7
V9YC		BP6FS
W16Y		---
XC12PEPB		PZFR6H
XJ10Y		BP6S
Y82		CM6
Z10		C6HSA
Z10G		C7HVX
Z12		C6HSA
Z6		C8HSA
Z7G		C7HVX
Z8		C7HSA
Z9Y		C7HSA
DENSO	→	NGK
9807B-5615P		ZFR6K-11
9807B-5615W		IZFR6K-11
J16AR-U11		BRE527Y-11
J16A-U11		BE527Y-11
J16AY		BP5EJ
J16AYR		BPR5EJ
J16BR-U		BRE529Y
J16B-U11		BE529Y-11
J16CRU		ZGR5E
K14PRU-11		BKR4E-11
K14P-U11		BKR5E-11
K16PRP11		BKR5EVX
K16PR-U		BKR5E
K16PR-U11		BKR5E-11
K16R-U		BKR5EYA
K16R-U11		BKR5EYA-11
K16TNRS9		BKR5EKC
K16TR-11		BKR5EKB-11
K20DTR-S11		ZFR6G
K20PBR-S10		BKUR6ET-10
K20PR-L11		BKR6EN-11
K20PR-TP11		BKR6EVX-11
K20PR-U		BKR6E
K20PR-U11		BKR6E-11
K20P-U		BK6E
K20P-U11		BK6E-11
K20R-U		BKR6EYA
K20R-U11		BKR6EY-11
K20TMR11		BKR6EKC-N-11
K20TNR-S		BKUR6EK



DENSO	→ NGK
K20TR-11	BKR6EKB-11
K20TRX	BKR6EKU
K22PB	BCP7ET
K22PR-L11	BKR7EN-11
K22PR-U	BKR7E
K22PR-U11	BKR7E-11
K22P-U11	BK7E-11
K22TM11	BK7EK-N-11
K22TMR	BKR7EKC-N
K22TMR11	BKR7EKC-N-11
K22TNR-S	BKUR7EK
K29A-Z	R7117-10
KJ16CR-L11	ZFR5F-11 / ZFR5J-11
KJ16CR-L11	ZFR5J-11
KJ206CR-L11	ZFR6F-11
KJ20CR-L11	ZFR6F-11/ZFR6J-11
KJ20DR-M11	ZFR6K-11
KJ20DR-M11	ZFR6K-11
KJ22CR-L11	ZFR7F-11 / ZFR7J-11
KJ22CRL8	ZFR7F
L14-U	A6
M17	A6
M22	A7
M24S	A8
MA14P-U	AP5FS
MA16PR-U	APR5FS
MA16PR-U11	APR5FS
MA16PR-U15	APR5FS
MA16P-U	AP5FS
MA17P-U	AP6FS
MA20PR-U	APR6FS
MA20P-U	AP6FS
MA20R-U	AR6FS
MA20R-U11	AR6FS
MA9P-U	AP4FS
P16R	BPR5EP-11
P16R-13	BPR5EP-13
P20PR11	PGR6A-11
P20R8	BPR6EP-8
PK16PR11	PFR5B-11
PK16PR-P11	PFR5J-11
PK16R11	BKR5EP-11
PK16TR11	BKR5EKP-11
PK20GR8	BKR6EPA-8
PK20PR11	PFR6B-11
PK20PR-L11	PFR6G-11
PK20PR-P	PFR6J
PK20PR-P11	PFR6J-11
PK20PR-TP	PFR6M
PK20R11	BKR6EP-11
PK20R-13	BKR6EP-13
PK20R8	BKR6EP-8

DENSO	→ NGK
PK20R-P8	BKR6EP-N-8
PK20TR11	BKR6EKP-11
PK22PR11	PFR7B-11
PK22PR-L11	PFR7G-11
PK22PR-L11	PZFR6F-11
PK22PR-L11	PFR7G-11
PK22PR-TP	PFR7M
PKJ16CR8	PZFR5F
PKJ16CR-L11	PZFR5F-11
PKJ20CR8	PZFR6F
PKJ20CR-L11	PZFR6F-11
PQ16R	BCPR5EP-11
PQ16R13	BCPR5EP-13
PQ16R8	BCPR5EP-8
PQ20R	BCPR6EP-11
PQ20R13	BCPR6EP-13
PQ20R8	BCPR6EP-8
PQ20R-P11	BCPR6EP-N-11
PQ20R-P8	BCPR6EP-N-8
PT116EPRL13	PTR5D-10
PT116VR-13	PTR5A-13
Q14R-U11	BCPR4EY-11
Q16PR-U	BCPR5E
Q16PR-U11	BCPR5EY-11
Q16P-U11	BCP5EY-11
Q16RU	BCPR5EY
Q16RU-11	BCPR5EY-11
Q16-U	BCP5EY
Q20PR-P11	BCPR6EVX-11
Q20PR-U	BKR6E
Q20PR-U11	BCPR6EY-11
Q20P-U	BCP6ES
Q20P-U11	BCP6E-11
Q20R-U11	BCPR6EY-11
Q22PR-U	BCPR7ES
Q22PR-U11	BCPR7ES-11
Q22P-U	BCP7ES
Q22P-U11	BCP7ES-11
Q27A-Z	R7232-9
QJ16AR-U	BCRE527Y
QJ20CR-11	ZFR6A-11
S27	SD9A
S29	SD10A
S29A	SD10A
SD29A	SD10A
SF-10	BUHX
SF-50	BUHW
SF-51	BUHW-2
SK16PR-E11	IFR5E-11/ BKR5EIX-11P
SK16PR-L11	IFR5G-11K
SK16RP8	IFR5T-8N
SK20BR11	IFR6A-11T



DENSO	→	NGK
SK20R11		IFR6A11
SK22PR-M11		IFR7G-11K
SKJ20DRM11		IZFR6K11
SKJ20DR-M11		IZFR6K-11
SVK20R-Z8		BKR6EP-8
T14PR-U		BPR4FS
T14PR-U15		BPR4FS-15
T16EPR-U		BPR5EFS
T16EX-U		BP5EFS
T16PR-U		BPR5FS
T16PR-U11		BPR5FS-11
T16PR-U15		BPR5FS-15
T16P-U		BP5FS
T16R-U		BR5FS
T16R-U15		BR5FS-15
T20EPR-U		BPR6EFS
T20EP-U		BP6EFS
T20EX-U		BP6EFS
T20MP-U		BPM6F
T20M-U		BM6F
T20PR-U		BPR6FS
T20PR-U11		BPR6FS-11
T20PR-U15		BPR6FS
T20P-U		BP6FS
T20R-U		BR6FS
T22EP-U		BP7EFS
T22MP-U		BPM7F
T22M-U		BM7F
TR20		B6HS
TR22		B7HS
TR22-10		B7HS-10
TR24		B8HS
TR24-10		B8HS-10
U14FSRUB		CR4HSB
U16FS-L		C5HSA
U16FSR-L		CR5HSA
U16FSR-U		CR5HSA
U16FSR-UB		CR5HSB
U16FS-U		C5HSA
U16FS-UB		C5HSB
U17F		C5HSA
U20FS		C6HSA
U20FS-L		C6HSA
U20FSR-U		CR6HSA
U20FS-U		C6HSA
U20M-U		CM6
U22ESR-N		CR7E
U22FS		C7HSA
U22FS-GU		C7HVX
U22FS-L		C7HSA
U22FSR-L		CR7HS
U22FS-U		C7HSA

DENSO	→	NGK
U24ES-N		C8E
U24ESR-N		CR8E
U24ETR		CR8EK
U24FE9		C8EH-9
U24FER9		CR8EH-9
U24FS		C8HSA
U24FS-C		L8A
U24FS-L		C8HSA
U24FSR-C		LR8A
U24FSR-U		CR8HS
U24FS-U		C8HSA
U27ES-N		C9E
U27ESR-N		CR9E
U27ETR		CR9EK
U27FE9		C9EH-9
U27FER-9		CR9EH-9
U31ESR-N		CR10E
U31ETR		CR10EK
VUH27D		IMR9C-9H
W14		B4
W14E		B4ES
W14EPR-U		BPR4ES
W14EP-U		BP4ES
W14EXR-U		BPR4EY
W14EXR-U11		BPR4EY-11
W14EX-U		BP4EY
W14EX-U11		BP4EY-11
W14F		B4H
W14FP		BP4H
W14FP-L		BP4HS
W14FPR		BPR4H
W14FPR-L		BPR4HS
W14FPR-UL		BPR4HS
W14FPR-UL10		BPR4HS-10
W14FP-U		BP4H
W14FP-UL		BP4HS
W14FP-UL10		BP4HS-10
W14FR-U		BR4HS
W14F-U		B4H
W14F-U10		B4H-10
W14L		B4L
W14LMR-US		BR4LM
W14LM-U		B4LM
W14LM-US		B4LM
W14MPR-U10		BPMR4A
W14MP-U10		BPM4A-10
W14MR-U		BMR4A
W14M-U		BM4A
W14M-US		BM4A
W14P		BP5S
W14PR-U		BP4
W14-U		B4



DENSO	→ NGK
W14-US	B4
W16EKR-S11	BUR5EB-11
W16EK-S11	BUR5EB-11/BU5EB-11
W16EP-GU	BP5EVX
W16EPR-S11	BUR5EA-11
W16EPR-U	BPR5ES
W16EPR-U11	BPR5ES-11
W16EP-U	BP5ES
W16EP-U10	BP5ES-11
W16EP-ZU	BP5EVX
W16ES	B5ES
W16ES-L	BR5ES/BR5EB
W16ES-L11	BUR5EB-11/BR5EB-11
W16ESR-U	BR5ES
W16ES-U	B5ES
W16ETR-S	BPR5EKA
W16ET-S	BP5EKA
W16EXR-U	BPR5EY
W16EXR-U11	BPR5EY-11
W16EX-U	BP5EAL
W16EX-U11	BP5EA-L-11
W16EX-U13	BP5ES-13
W16FP	BP5HS
W16FP-L	BP5HA
W16FPR	BPR5HS
W16FPR-U	BPR5HS
W16FP-U	BP5HS
W16FP-U10	BP5HS-10
W16FP-UL	BP5HA
W16FS	B5HS
W16FSR	BR5HS
W16FS-U	B5HS
W16LS	B6L
W16PR-U	BPR5S
W16P-U	BP5S
W17P	BP6S
W17PR-U	BP6S
W20DTR-S	BKR6EKB
W20DTR-SA	BPR6EKB-L
W20EA	B6EM
W20EAR	BR6EM
W20EKR-S11	BUR6EB-11
W20EK-S11	BUR6EB-11/BU6EB-11
W20EP	B6ES
W20EPB	BP6ET
W20EPBRS	BUR6ET
W20EP-GU	BP6EVX
W20EPRS-11	BUR6EA-11
W20EPR-U	BPR6ES
W20EPR-U10	BPR6ES-11
W20EPR-U11	BPR6ES-11
W20EP-S11	BU6EA-11

DENSO	→ NGK
W20EP-U	BP6ES
W20EP-U11	BP6ES-11
W20EP-ZU	BP6EVX
W20ES	B6ES
W20ES-GU	B6EVX
W20ES-L	BR6ES/B6EB
W20ES-L11	BUR6EB-11/B6EB-11
W20ESR	BR6ES
W20ESR-L	BR6ES/BR6EB
W20ESR-L11	BUR6EB-11/BR6EB-11
W20ES-U	B6ES
W20ES-U11	B6ES-11
W20ES-ZU	B6EVX
W20ET	BP6EK
W20ET-L	BP6EKN
W20ETR-L	BPR6EKN
W20ETR-S	BPR6EK-A
W20ET-S	BP6EK-A
W20EXR-U	BPR6EY
W20EXR-U11	BPR6EY-11
W20EX-U	BP6EY
W20EX-U11	BP6EY-11
W20EX-U13	BP6ES-13
W20FP	BP6HS
W20FP-L	BP6HSA
W20FPR	BPR6HS
W20FPR-U	BPR6HS
W20FP-U	BP6HS
W20FP-U10	BP6HS-10
W20FS	B6HS
W20FS-GU	B6HVX
W20FSR	BR6HS
W20FSR-U	BR6HS
W20FS-U	B6HS
W20FS-ZU	B6HVX
W20M	BM6A
W20MP-U	BPM6A
W20MP-U10	BPM6A-10
W20MR-U	BMR6A
W20M-U	BM6A
W20M-US	BM6A
W20S	B6S
W20SR-U	BR6S
W20S-U	B6S
W21ES-L11	BR6EB-L-11/B6EB-L-11
W21ESR-L11	BR6EB-L-11
W22EA	B7EM
W22EAR	BR7EM
W22EB	BR7ET/B7ET
W22EBR	BR7ET
W22EDR	BR7EQ
W22EDR14	BR7EQ-14



DENSO	→ NGK
W22EK-S11	BUR7EB-11/BU7EB-11
W22EP	BP7ES
W22EP11	BP7ES-11
W22EP-GU	BP7EVX
W22EPR-U	BPR7ES
W22EP-S11	BU7EA-11
W22EP-U	BP7ES
W22EP-ZU	BP7EVX
W22ES	B7ES
W22ES-GU	B7EVX
W22ES-L	B7EB
W22ES-L11	B7EB-11
W22ESR	BR7ES
W22ESR-L	BR7EB
W22ESR-L11	BR7EB-11
W22ESR-U	BR7ES
W22ES-U	B7ES
W22ES-U11	B7ES-11
W22ES-ZU	B7EVX
W22FP	BP7HS
W22FPR-U	BPR7HS
W22FP-U	BP7HS
W22FP-U10	BP7HS-10
W22FS	B7HS
W22FS-GU	B7HVX
W22FSR	BR7HS
W22FS-U	B7HS
W22FS-ZU	B7HVX
W22M	BM7A
W22MP-U	BPM7A
W22MP-US	BPM7A
W22M-U	BM7A
W22M-US	BM7A
W22S	B7S
W22S-U	B7S
W24EP	BP8ES
W24EP-11	BP8ES
W24EP-U	BP8ES
W24ES	B8ES
W24ES-GU	B8EVX
W24ESR	BR8ES
W24ESR-U	BR8ES
W24ES-U	B8ES
W24ES-U11	B8ES-11
W24ES-V	B8EG
W24ES-ZU	B8EGV
W24FP-L	BP8HSA
W24FP-U	BP8HS
W24FS	B8HS
W24FS-GU	B8HVX
W24FSR	BR8HS
W24FS-U	B8HS

DENSO	→ NGK
W24FS-U10	B8HS-10
W24FS-ZU	B8HVX
W24S	B8S
W24S-U	B8S
W25EA	B8EM
W25EAR	BR8EM
W25EB	BR8ET/B8ET
W25EBR	BR8ET
W25EDR	BR8EQ
W25EDR14	BR8EQ-14
W25EN	B8EG
W25EPT	B8EGP
W25FC	B8HCS
W25FN	B8HVX
W27EBR	BR9ET
W27EDR14	BR9EQ-14
W27EMR-C	BR9ECM
W27EN	B9EG
W27EPT	B9EGP
W27ES	B9ES
W27ES-GU	B9EVX
W27ESR	BR9ES
W27ES-U	B9ES
W27ES-V	B9EG
W27ES-ZU	B9EGV
W27FC	B9HCS
W27FS	B9HS
W27FS-GU	B9HVX
W27FSR	BR9HS
W27FS-U	B9HS
W27FS-U10	B9HS-10
W27FS-ZU	B9HVX
W27S	B9S
W27S-U	B9S
W29EPT	B95EGP
W29ES-GU	B95EGV
W29ES-ZU	B95EGV
W31EN	B10EG
W31EPT	B10EGP
W31ES	B10ES
W31ES-GU	B10EVX
W31ES-U	B10ES
W31ES-ZU	B10EGV
W31FS	B10HS
W31FS-GU	B10HVX
W31FS-ZU	B10HVX
W32EPT	B10SEGP
W34ES-ZU	B11EGV
W9	B2
W9EP	BP2E
W9EXR-U	BPR2ES
W9EX-U	BP2E



DENSO	→	NGK
W9FP		BP2H
W9FP-L		BP2HS
W9FP-UL		BP2HS
W9LMR-US		BR2LM
W9LM-US		B2LM
W9P		BP4
W9-U		B2
WA20M		BM6F
WA20M-U		BM6F
WA22M		BM7F
WA22M-U		BM7F
X16FSR-U		DR5HS
X20EPR-GL		PJR6A
X20FS-GU		D6HVX
X20FSR-U		DR6HS
X20FS-U		D6HA
X22EPR-GL		PJR7A
X22EPR-U9		DPR7EA-9
X22EP-U9		DP7EA-9
X22ES-GU		D7EVX
X22ESR-U		DR7ES
X22ES-U		D7EA
X24EPR-GL		PJR8A
X24EPR-U9		DPR8EA-9
X24EP-U9		DP8EA-9
X24ES-GU		D8EVX
X24ESR-U		DR8ESL
X24ES-U		D8EA
X24FSR-U		DR8HS
X24FS-U		D8HA
X24GPR-U		DPR8Z
X24GP-U		DP8Z
X27EPR-U9		DPR9EA-9
X27EP-U9		DP9EA-9
X27ESR-U		DR8ES
X27ES-U		D9EA
X27GPR-U		DPR9Z
X27GP-U		DP9Z
X31ES-U		D10EA
XU20EPR-U		DCPR6E
XU20EP-U		DCP6E
XU22EPR-U		DCPR7E
XU22EPR-ZU		DCPR7EVX
XU22EP-U		DCP7E
XU22EP-ZU		DCP7EVX
XU24EPR-U		DCPR8E
XU24EPR-ZU		DCPR8EVX
XU24EP-U		DCP8E
XU24EP-ZU		DCP8EVX
Y27FER		ER9EH
Z20ES-U		D6EA

EYQUEM	→	NGK
1000		B8HS
1000 MOTO		B8HS
1000CM		B7S
1000L		B8ES
1000L MOTO		B8HS
1000M		B8HS
100M		B8HS
1100		B9HS
1100L		B8ES
1100L MOTO		B8ES
1150L		B9ES
200		B4H
202CT		B2LM
300AM		B4L
30AM		B4L
400J		BR5FS
406		BP6HS
450JS		BPR4FS-15
450L		B5ES
480CS		BP5S
500AM		B6L
500C		B6S
500CJT		BM6F
500CM		B6S
500CS		BP5S
500CT		BM6A
500J		BR6FS
500JS		BPR4FS
500M		B5HS
502 MOTO		B4H
502CT		B4LM
505JS		BP5FS
50AM		B-6L
50M		B5HS
520CS		BP5S
550CS		BP5S
550JS		BPR5FS
550LS		BP5ES
550S		BP4HS
580LS		BP5ES
580S		BP4HS
600CS		BP5S
600JS		BPR6FS
600L		B6ES
600LS		BP6ES
600S		BP5HS
700		B6HS
700 MOTO		B6HS
700CM		B6S
700CTS		BP6A
705JS		BP7FS
705L		B6ES



EYQUEM	→ NGK
705L MOTO	B6ES
705S	BP6HS
705S MOBY MOTO	B5HS
707LS	BP6ES
70M	B6HS
750	BP6HS
750L	B6ES
750LJS	BP6EFS
750LS	BP6ES
753LJS	BP6EFS
755	B6HS
755 MOTO	B6HS
755CJT	BM7F
755CM	B6S
755CT	BM7A
755L	B6ES
755L MOTO	B6ES
755LJS	BP6EFS
755LS	BP6ES
755LS MOTO	BP6ES
755M	B6HS
755S	BP6HS
75LM	B6ES
75M	B6HS
775SX	BP6HS
775X	B6HS
800L	B6ES
800LJS	BP6EFS
800LS	BP6ES
800LS MOTO	BP6ES
802L	B6ES
803LJS	BP6EFS
805L	B6ES
805L MOTO	B6ES
805LJS	BP7EFS
805LJSP	BP7EFVX
805LP	B8EVX
850	B7HS
850 MOTO	B7HS
850LS	BP7ES
883LJP	B8EFS
C32	B5HS
C32LS	BP5ES
C32S	BP5HS
C42LJS3	BP6EFS
C42S	BP6HS
C52LS	BP5ES
C62	B7HS
C62LJS	BP6EF
C62LJS	BP6EFS
C62LS	BP6E
C62LS	BP6ES

EYQUEM	→ NGK
C62LS3X	BP5ET
C62S	BP7HS
C72LJS	BP7EFS
C72LS	BP7ES
C72LS3X	BP6ET
C82LJS	BP7EFS
C82LS	BP7ES
C82LS3X	BP7ET
C92LS	BP8ES
D1000	D8HA
D1000 MOTO	D8HA
D1000L	D9EA
D1050L	D9EA
D755 MOTO	D6HA
D775	D6HA
D800L	D7EA
D800L MOTO	D7EA
D900L	D8EA
FC42LS	BCP5ES
FC52LS	BCP5ES
FC52LS	BCP5E
FC58LS	BCP6ES
FC62LS	BCP6ES
FC62LS2	BCP6ES
FC62LS3	BCP6ET
FC62LS3X	BCP6ET
FC72LS	BCP7ES
FC82LS	BCP7E
FC82LS1	BCP7ES
FC82LS2	BCP7ES
FN52LS	BK5ESZ
K200M	A6
K300J	A5FS
K300JS	AP5FS
K300M	A6
K350JS	AP5FS
K450JS	AP5FS
K500M	A6
K550JS	AP6FS
K600M	A6
K750M	A7
KC62JS	AP6FS
R1000	BR8HS
R1000L	BR8ES
R850	BR7HS
RC32LS5	BPR4ES-11
RC42S	BPR6HS
RC52LS	BPR5EA
RC52LS5	BPR5EA-11
RC52LZ3EX	BUR5ET
RC52LZE	ZGR5A
RC58LZ3EX	BUR6ET



EYQUEM	→	NGK
RC62HJSDP		PTR5A-13
RC62LJS		BPR6EFS
RC62LS		BPR6ES
RC62LS5		BPR6ES-11
RC62S		BPR7HS
RC82LS		BPR7ES
RC82LS5		BPR7EY-11
RFC42LS		BCPR5ES
RFC42LS2E		BKR5EK
RFC50LZ2E		BKR5EK
RFC52LS		BCPR5ES
RFC52LS3		BCPR5ET
RFC52LS5		BKR5E-11
RFC52LS5		BCPR5ES-11
RFC52LSP		BKR6EK
RFC52LZE		ZFR5F
RFC52LZK		BKR5EZ
RFC57LS3		BCPR6ET
RFC58LS		BKR6E
RFC58LS2E		BKR6EK
RFC58LS3		BCPR6ET
RFC58LS5		BKR6ES-11
RFC58LS5		BCPR6ES-11
RFC58LSP		BKR6EZ
RFC58LZ		BKR6EK
RFC58LZ2		BKR6EKC
RFC58LZ2E		BKR5EZ
RFC58LZ3EX		BKUR6ET
RFC58LZ5		BKR6EY-11
RFC58LZE5		ZFR6F-11
RFC62LS3X		BCPR6ET
RFC62LS5		BCPR6ES-11
RFC62LZ3X		BKUR7ET
RFC82LS		BCPR7ES
RFC82LS5		BCPR7ES-11
RFN52HZ		LF5B
RFN58HZ		LF6B
RFN58LZ		BKR6EK
T850		C7HSA
XKC62JS		APR6FS
HARLEY-DAVIDSON	→	NGK
10R12A		DCPR9E
3		B6L
3-4		BP5S
4		B6L
4-5		BP7HS
4R		B6L
4R5		BPR7HS-10
5		B6S
5A6		BP5EY
5R6		BPR5EY

HARLEY-DAVIDSON	→	NGK
5R6A		BPR5EY-11
5RL		ZGR5C
6R12		DPR7EA-9
8		B10EGV
HONDA	→	NGK
12290-PNE-0030		ZFR6K-11
12290-PRB-A01		IFR7G-11K
31911-MBW-E11		IMR8C-9H
31912-MBW-E110		IMR9C-9H
31912-MCW-0030		IMR9B-9H
31912-MEL-003		IMR9C-9HES
31914-ZOH-003		CMR4H
31915-ZOH-003		CMR5H
31916-ZOH-003		CMR6H
31918-MEB-671		IFR8H11
31988-GEV-761		ER8EH-N
94701-00408		CR9EIA-9
98049-58716		ER8EH
98049-59716		ER9EH
98049-60716		ER10EH
98052-56471		CM6
98056-54717		C4HA
98056-54718		CR4HSA
98056-55713		C5HSA
98056-55717		C5HA
98056-55718		CR5HSA
98056-55777		CR5HSB
98056-56713		C6HSA
98056-56716		CR6HS
98056-56717		C6HA
98056-56718		CR6HSA
98056-57713		C7HSA
98056-57716		CR7HS
98056-57717		C7HA
98056-57718		CR7HSA
98056-58713		C8HSA
98056-58716		CR8HS
98056-58717		C8HA
98056-58718		CR8HSA
98059-55916		CR5EH-9
98059-57910		C7EH-9
98059-57916		CR7EH-9
98059-58910		C8EH-9
98059-58916		CR8EH-9
98059-59910		C9EH-9
98059-59916		CR9EH-9
98059-5991F		CR9EHVX-9
98059-5991U		IMR9A-9H
98059-599U		CR9EHI-9
98059-60916		CR10EH-9
98061-57611		DP7Z



HONDA	→	NGK
98061-57616		DPR7Z
98061-58616		DPR8Z
98061-59616		DPR9Z
98066-54716		DR4HS
98066-55710		D5HS
98066-55716		DR5HS
98066-56710		D6HS
98066-56716		DR6HS
98066-56717		D6HA
98066-58714		D8HS
98066-58716		DR8HS
98066-58717		D8HA
98066-60714		D10HS
98069-38716		DR8ESL
98069-55911		DP5EA-9
98069-55916		DPR5EA-9
98069-56716		DR6ES
98069-56717		D6EA
98069-56718		DR6EA
98069-56911		DP6EA-9
98069-56916		DPR6EA-9
98069-57716		DR7ES
98069-57717		D7EA
98069-5771P		DR7EA
98069-57726		DR7EA
98069-57911		DP7EA-9
98069-57911		DPR7EA-9
98069-57912		DPR7EVX-9
98069-57916		DPR7EA-9
98069-5791U		LR7A9
98069-58716		DR8ES
98069-58717		D8EA
98069-58911		DP8EA-9
98069-58912		DPR8EVX-9
98069-58916		DPR8EA-9
98069-59717		D9EA
98069-59911		DP9EA-9
98069-59912		DPR9EVX-9
98069-59916		DPR9EA-9
98069-5991F		DPR9EVX-9
98069-60711		D10ES
98069-60717		D10EA
98069-63410		D13E
98073-52710		B2
98073-54710		B4
98073-54740		BM4A
98073-54744		BMR4A
98073-54771		BPM4A
98073-54776		BPMR4A
98073-54941		BPM4A-10
98073-54944		BPMR4A-10
98073-56740		BM6A

HONDA	→	NGK
98073-56741		BPM6A
98073-56744		BMR6A
98073-56941		BPM6A-10
98073-56944		BPMR6A-10
98076-52711		BP2HS
98076-52716		BPR2HS
98076-5401G		BR4HSA-10
98076-54710		B4H
98076-54711		BP4HS
98076-54713		BP4HSA
98076-54715		BPR4HSA
98076-54716		BR4HS
98076-54717		BPR4HS
98076-5471G		BR4HSA
98076-54746		BR4HS
98076-54747		BPR4HS
98076-54911		BP4HS-10
98076-54914		BPR4HS-10
98076-54944		BPR4HS-10
98076-55711		BP5HS
98076-55716		BR5HS
98076-55717		BPR5HS
98076-55719		BP5HS
98076-55747		BPR5HS
98076-5601G		BR6HSA-10
98076-56711		B6HS
98076-56713		BP6HSA
98076-56715		BPR6HSA
98076-56716		BR6HS
98076-56717		BPR6HS
98076-56719		BP6HS
98076-5671G		BR6HSA
98076-5671M		B6HSA
98076-56741		B6HS
98076-56747		BPR6HS
98076-56917		BPR6HS-10
98076-57710		B7HS
98076-57711		BP7HS
98076-57716		BR7HS
98076-57717		BPR7HS
98076-57740		B7HS
98076-5801G		BR8HSA-10
98076-58710		B8HS
98076-58711		BP8HS
98076-58713		BPR8HSA
98076-58715		BPR8HSA
98076-58716		BR8HS
98076-58717		BPR8HS
98076-5871G		BR8HSA
98076-5871M		B8HSA
98076-58740		B8HS
98076-58747		BPR8HS



HONDA	→	NGK
98076-59710		B9HS
98076-59716		BR9HS
98079-54148		BCPR4E-11
98079-5414G		ZFR4F-11
98079-54173		BUR4EB-11
98079-54817		BPR4ES
98079-54841		BP4ES
98079-54846		BPR4ES
98079-55140		BCP5EY-11
98079-55141		BP5EY-11
98079-55144		BP5ES-11
98079-55145		BPR5ES-11
98079-55146		BPR5EY-11
98079-55147		BCPR5ES-11
98079-55148		BCPR5E-11
98079-55149		BCPR5EY-11
98079-5514A		BCPR5EYN-11
98079-5514B		BCP5E-11
98079-5514E		BKR5E-11
98079-5514F		BCPR5EVX-11
98079-5514H		PFR5G-11
98079-5514J		BKR5EN-11
98079-5514P		ZFR5J-11
98079-5515G		ZFR6F-11
98079-55173		BUR5EB-11
98079-55174		BU5EB-11
98079-55176		BR5EB-11
98079-55178		B5EB-11
98079-55810		B5ES
98079-55811		BP5ES
98079-55816		BR5ES
98079-55817		BPR5ES
98079-55840		B5ES
98079-55841		BP5ES
98079-55844		BP5EVX
98079-55846		BPR5ES
98079-55847		BR5ES
98079-55848		B5EB
98079-55849		BR5EB
98079-5585V		ZGR5A
98079-5587V		ZGR5A
98079-55941		BP5EY
98079-55946		BPR5EY
98079-56140		BCP6EY-11
98079-56144		BP6ES-11
98079-56145		BPR6ES-11
98079-56146		BPR6EY-11
98079-56147		BCPR6ES-11
98079-56148		BCPR6E-11
98079-56149		BCPR6EY-11
98079-5614A		BCPR6EYN-11
98079-5614B		BCP6E-11

HONDA	→	NGK
98079-5614E		BKR6E-11
98079-5614F		BCPR6EVX-11
98079-5614G		ZFR6F-11
98079-5614H		PFR6G-11
98079-5614J		BKR6EN-11
98079-5614N		PZFR6F-11
98079-5614P		ZFR6J-11
98079-5615G		ZFR6F-11
98079-5615N		PZFR6F-11
98079-56173		BUR6EB-11
98079-56174		BU6EB-11
98079-56175		BP6EY-11
98079-56178		B6EB-11
98079-56179		BR6EB-11
98079-5617U		IFR6L11
98079-5617U		IFR6L11
98079-56614		B6EVX
98079-56810		B6ES
98079-56811		BP6ES
98079-56817		BR6ES
98079-56840		B6ES
98079-56841		BP6ES
98079-56844		BP6EVX
98079-56846		BPR6ES
98079-56847		BR6ES
98079-56848		B6EB
98079-56849		BR6EB
98079-56941		BP6EY
98079-56946		BPR6EY
98079-569BU		IFR6C-S
98079-57140		BCP7EY-11
98079-57144		BP7ES-11
98079-57145		BPR7ES-11
98079-57146		BPR7EY-11
98079-57147		BCPR7ES-11
98079-57148		BCPR7E-11
98079-57149		BCPR7EY-11
98079-5714A		BCPR7EYN-11
98079-5714B		BCP7E-11
98079-5714E		BKR7E-11
98079-5714F		BCPR7EVX-11
98079-5714G		ZFR7F-11
98079-5714H		PFR7G-11
98079-5714J		BKR7EN-11
98079-5715H		PFR7G-11
98079-57173		BUR7EB-11
98079-57174		BU7EB-11
98079-57175		BR6EBL-11
98079-57176		B6EBL-11
98079-57177		BR7EB-11
98079-57178		B7EB-11
98079-57179		BP7EY-11



HONDA	→	NGK
98079-5717U		IFR7L11
98079-571BV		IFR7G-11KS
98079-57614		B7EVX
98079-57810		B7ES
98079-57811		BP7ES
98079-57816		BR7ES
98079-57840		B7ES
98079-57841		BP7ES
98079-57846		BPR7ES
98079-57847		BR7ES
98079-57848		B7EB
98079-57849		BR7EB
98079-5785G		ZFR7F
98079-57876		BR7ES
98079-57877		BR7ES
98079-5787G		ZFR7F
98079-57941		BP7EY
98079-57946		BPR7EY
98079-5814E		BKR8E-11
98079-58644		B8EVX
98079-58646		BR8EVX
98079-58648		B8EG
98079-58649		BR8EG
98079-58678		B8EG
98079-58679		BR8EG
98079-58810		B8ES
98079-58816		BR8ES
98079-58819		BR8ECS
98079-58840		B8ES
98079-58842		B8ECS
98079-58845		BR8ECM
98079-58846		BR8ES
98079-58847		BPR8ES
98079-58870		B8ES
98079-58876		BR8ES
98079-59644		B9EVX
98079-59646		BR9EVX
98079-59648		B9EG
98079-59649		BR9EG
98079-59678		B9EG
98079-59679		BR9EG
98079-59810		B9ES
98079-59811		B9ES
98079-59816		BR9ES
98079-59819		BR9ECS
98079-59842		B9ECS
98079-59845		BR9ECM
98079-59847		BR9ES
98079-59870		B9ES
98079-59876		BR9ES
98079-60616		BR10EVX
98079-60646		BR10EVX

HONDA	→	NGK
98079-60648		B10EG
98079-60649		BR10EG
98079-60676		BR10EVX
98079-60678		B10EG
98079-60679		BR10EG
98079-60817		BR10ES
98079-60819		BR10ECS
98079-60842		B10ECS
98079-60845		BR10ECM
9807B-5615W		IZFR6K11
9807B-5617W		IZFR6K11
98179-56841		BP6ES

ISKRA	→	NGK
F100RS		BR8HS
F100S		B8HS
F20		B4H
F50		B5HS
F55PS		BP5HS
F65PRS		BPR6HS
F65PS		BP6HS
F70		B5HS
F75RS		BR6HS
F75S		B6HS
F805RS		BR7HS
F80S		B7HS
F85PS		BP7HS
F95PS		BP7HS
FE100RS		BR9ES
FE100S		B9ES
FE145P		BP9ES
FE155P		BP8EVX
FE45P		BP5ES
FE50		B5ES
FE55LRS		ZGR5A
FE55LTXS		BUR5ET
FE55LXS		ZGR5A
FE55PRS		BPR5ES
FE55PS		BP5ES
FE55PTS		BP5ET
FE65LTXS		BUR6ET
FE65PP2		BP6EVX
FE65PRP2		BPR6ES
FE65PRS		BPR6ES
FE65PS		BP6ES
FE65PTRS		BPR6ET
FE65PTS		BP6ET
FE75RS		BR7ES
FE75S		B7ES
FE80RS		BR8ES
FE80S		B8ES
FE85PRS		BPR7ES



ISKRA	→	NGK
FE85PS		BP7ES
FE85PTRS		BP7ET
FE85PTS		BP7ET
FET55PRS		BPR5EFS
FET55PS		BP5EFS
FET65PRS		BPR6EFS
FET65PS		BP6EFS
FET75PRS		BPR7EFS
FET75PS		BP7EFS
FS50KR		BR2LM
FS55P		BP6S
FS70		B6S
FS70C		BPM6A
FS75		B7S
FS75C		BPM7A
FT65PS		BP6FS
FT95PS		BP8FS
FUT55PRP2-13		PTR5A-13
M60		A6
M75		A7
M80		A8
MT65PRS		APR6FS
MT65PS		AP6FS
SFE55LRS		ZFR5F
SFE55LXS		ZFR5F
SFE55PRS		BKR5ES
SFE55PRS		BCPR5ES
SFE55PS		BCP5ES
SFE55PTRS		BCPR5ET
SFE55PTS		BCP5ET
SFE65LDRS		BKR5EK
SFE65LRS		ZFR6A-11
SFE65LTXS		BKUR6ET
SFE65LXS		ZFR6A-11
SFE65PDRS		BKR6EKC
SFE65PRS		BKR6E
SFE65PRS		BKR6ES
SFE65PS		BCP6ES
SFE65PTRS		BCPR6ET
SFE65PTS		BCP6ET
SFE85LDRS		BKR6EK
SFE85LTRS		BKUR7ET
SFE85PR5		BKR7ES
SFE85PRS		BCPR7ES
SFE85PS		BCP7ES
SFE85PTRS		BCPR7ET
SFE85PTS		BCP7ET
T90		C7HSA
TWE85PRS		DCPR8E
TWE85PS		DCP7E

ISOLATOR	→	NGK
6B		BP6HS
7A		B6HS
7B		BP6HS
7D		BP6ES
A5D		BP7EFS
A7D		BP6EFS
FM14-145/2		BP5ES
FM14-175/2		BP6ES
FM14-200/2		BP6ES
FM14-225/2		BP7ES
M14-145		B5HS
M14-175		B6HS
M14-175/2		B6ES
M14-225		B7HS
M14-240		B8HS
M14-260		B9HS
M14-95		B4H
M18-225		A7
M18-240		A7
PM14-225		BP7HS
U7D		BCP6ES
U8D		BCP5ES
ZM14-260		B8HS
ITALJET	→	NGK
94004		BR7HS
94015		DR8EA
94025		BR8HS
94029		BR9ES
94032		CR7E
KAWASAKI	→	NGK
92070-2077		BPR6ES
E92070001		B7HS
E92070014		B6ES
E92070015		B7ES
E92070036		B9HS
E92070037		B8ES
E92070037		B8ES
E92070054		B9ES
E92070054		B9ES
E920701002		B7ES
E920701019		DR8ES
E920701019		DR8ES
E920701024		BP6ES
E920701025		BPR6ES
E920701025		BPR6ES
E920701026		BP7ES
E920701027		BPR7ES
E920701034		D9EA
E920701034		D9EA
E920701044		BPR8ES



KAWASAKI	→	NGK
E920701065		DPR8EA-9
E920701065		DPR8EA-9
E920701066		DP8EA-9
E920701068		DPR9EA-9
E920701068		DPR9EA-9
E920701109		BR9ES
E920701109		BR9ES
E920701113		DR7ES
E920701114		C6HSA
E920701116		DR8ESL
E920701116		DR8ESL
E920701125		DPR7EA-9
E920701125		DPR7EA-9
E920701138		DPR6EA-9
E920701143		CR9E
E920701143		CR9E
E920701145		CR9EK
E920701145		CR9EK
E920701154		CR7HSA
E920701155		CR8HSA
E920701155		CR8HSA
E920701158		CR8EK
E920701158		CR8EK
E920701169		CR8E
E920701169		CR8E
E920701173		BR10ES
E920701189		DR9EA
E920701189		DR9EA
E920701199		DR8EA
E920701199		DR8EA
E920701209		CR7E
E920701209		CR7E
E920701250		DPR5EA-9
E920701250		DPR5EA-9
E920701254		CR9EKPA
E920701255		CR8EKPA
E920702078		BR8ES
E920702078		BR8ES
LODGE		
15HLNY	→	BP6ES
25HLD		BCP6ET
25HLNY		BP7ES
25XL		BP6ES
2BTNY		AP5FS
2H		B7HS
2H12		D8HA
2HA		B6S
2HL		B7ES
2HL10		C7HSA
2HLD		BCP6ES
2HL-E		B7ES

LODGE	→	NGK
2HLN		B7ES
2HLNY		BP7ES
2HN		B7HS
2HNY		BP7HS
2H-TNY		AP7FS
2HTY		BP6FS
2HV		A8
2XL		BP6ES
3B-TY		BP4FS
3HAN		B8S
3HAN/M		B9S
3HLN		B8ES
3HLNY		BP7ES
3HN		B8HS
3HNY		BP8ES
4HLNY		BP8ES
5HLNY		BP8ES
BAN		B4
BANY		BP5S
BBANY		BP4
BBNY		BP4H
BLN		B4ES
BLNY		BP5ES
BLTY		BPR5EFS
BN		B4H
BTNY		AP5FS
B-TY		BP5FS
BV		AB2
C3		A5FS
CAN		B6S
CANB		BPM6A
CANC		BM6A
CANY		BP6S
CL14		B5ES
CLN		B6ES
CLN14P		B5ES
CLNH		B5ES
CLNY		BP5ES
CN		B5HS
CNY		BP5HS
CSN		B4L
CTN18		A5FS
CTNY		AP5FS
CTY		BP5FS
CV		A6
H		B6HS
H12		D6HA
H18		A7
HA		B7S
HAN		B7S
HAN/M		B7S
HB12		D6HA



LODGE	→	NGK
HBAN		B6S
HBL12		D8EA
HBLN		B5ES
HBN		B5HS
HBSN		B6L
HBTNY		AP6FS
HBTY		BP5FS
HBV		A6
HL		B6ES
HL12		D9EA
HL14		B6ES
HL-E		B6ES
HLN		B6ES
HLNP		B6ES
HLNY		BP6ES
HN		B6HS
HNY		BP6HS
HT14		BP5FS
HT18		AP6FS
HTNY		AP6FS
H-TY		BP6FS
HV		A7
MARELLI	→	NGK
7LCR		BKR6E
7LPR		BKR6E
8LCR		BCPR7ES
8LDCR		PTR5A-13
8LPR		BCPR7ES
AW56C		BM7A
AW5C		BM6A
CM1N		AB2
CM2N		AB2
CM3N		A6
CM4N		A6
CM5N		A6
CM6N		A7
CU7N		C7HSA
CW101L		B85EGV
CW10L		B8EG
CW112L		B9EG
CW11L		B9EG
CW12L		B9EG
CW12NV		BUH
CW13L		B10EG
CW14L		B10EG
CW225A		B6HS
CW250A		B7HS
CW25N		B4H
CW260N		B7HS
CW2C		B2
CW2CJ		B2

MARELLI	→	NGK
CW2L		B4ES
CW2N		B4H
CW3C		B4
CW3CJ		B4
CW3CP		BP4
CW3L		B4ES
CW3N		B4H
CW4A		B5ES
CW4C		B4
CW4CJ		B4
CW4CP		BP4
CW4L		B4ES
CW4LP		BP4ES
CW4N		B4H
CW4NJ		B4H
CW55N		B5HS
CW5C		B4
CW5CP		BP5S
CW5L		B5ES
CW5LJ		B5ES
CW5LP		BP5ES
CW5LS		B5ES
CW5LSZ		B5ES
CW5N		B5HS
CW5NJ		B5HS
CW5NP		BP5HS
CW5NR		BR5HS
CW5NS		B5HS
CW5NSZ		B5HS
CW67L		B6ES
CW67LP		BP6ES
CW67N		BP6HS
CW67NJ		B6HS
CW67NR		BR6HS
CW67P		BP5ES
CW6C		B6S
CW6CE		BM6A
CW6CJ		B6S
CW6L		B5ES
CW6LJ		B5ES
CW6LP		BP5ES
CW6LR		BR5ES
CW6LS		B5ES
CW6LSZ		B5ES
CW6N		B6HS
CW6NE		BM6A
CW6NJ		B6HS
CW6NP		BP6HS
CW6NPR		BPR6HS
CW6NR		BR6HS
CW75LP		BP6ES
CW78L		B6ES



MARELLI	→	NGK
CW78LP		BP6ES
CW78LPR		BPR6ES
CW78LPS		BP6ES
CW7C		B6S
CW7L		B6ES
CW7LCR		BKR6E
CW7LJ		B6ES
CW7LP		BP6ES
CW7LPH		BP6ES
CW7LPR		BPR6ES
CW7LR		BR6ES
CW7N		B6HS
CW7NJ		B6HS
CW7NP		BP6HS
CW7NPR		BPR6HS
CW7NR		BR6HS
CW89LP		BP7ES
CW8CJ		B7S
CW8L		B7ES
CW8LCR		BCPR7ES
CW8LJ		B7ES
CW8LP		BP7ES
CW8LPR		BPR7ES
CW8LPS		BP7ES
CW8N		B7HS
CW8NP		BP7HS
CW8NR		BR7HS
CW9L		B8ES
CW9LJ		B8ES
CW9LP		BP8ES
CW9N		B8HS
CWC12NJ		B8HS
CWC67NJ		B6HS
CWC6NJ		B6HS
CWC7NJ		B6HS
CWC9NJ		B7HS
CWF11L		B8EVX
CWP10L		B9EVX
CWP10N		B9HVX
CWP11L		B10EGV
CWP5N		B6HVX
CWP6N		B6HVX
CWP7L		B6EVX
CWP7N		B6HVX
CWP8L		B7EVX
CWP8N		B7HVX
CWP9L		B8EVX
CWP9N		B8HVX
CX6N		D6HA
CX8L		D8EA
CX8N		D8HA
DW4CJR		BR6S

MARELLI	→	NGK
F6NC		BP5HS
F6NCR		BPR5HS
F7LC		BP6ES
F7LCR		BPR6ES
F7NC		BP6HS
F7NCR		BPR6HS
F8LC		BP7ES
F8LCR		BPR7ES
FC6N		B5HS
FC7N		B6HS
FC9L		BP8ES
SW5C		BM6F
T7LC		BP6EFS
T7LCR		BPR6EFS
T8LC		BP7EFS
T8LCR		BPR7EFS
TM2NP		AP5FS
TM3N		A5FS
TM3NP		A5FS
TM4N		A5FS
TM4NP		AP6FS
TW4LP		BP5EFS
TW5NP		BP5FS
TW6NP		BP6FS
TW78LP		BP6EFS
TW78LPR		BPR6EFS
TW78NPR		BPR6FS
TW7LP		BP6EFS
TW7LPR		BPR6EFS
TW7NP		BP6FS

SPLITFIRE	→	NGK
TP006A		BP8EVX
TP006B		BP7EVX
TP006C		BP6EVX
TP006D		BP5EVX
TP006E		BP5EVX
TP406B		B9EVX
TP406B		BR9EVX
TP406C		B8EVX
TP406C		BR8EVX
TP416B		DP9EVX-9
TP416C		DP8EVX-9
TP430B		CR9EVX
TP430C		CR8EVX

SUZUKI	→	NGK
09482-00036		BP4H
09482-00066		B9ES
09482-00082		B7HS
09482-00084		BP6HS
09482-00088		BR6HS



SUZUKI	→	NGK
09482-00089		B7ES
09482-00091		B8ES
09482-00095		B6HS
09482-00098		BR9ES
09482-00102		BR8HS
09482-00105		BP7HS
09482-00111		AU10EFP
09482-00115		BR9EVX
09482-00116		BR7HS
09482-00117		BR7ES
09482-00118		BP6ES
09482-00121		BR8ES
09482-00124		BP5HS
09482-00127		BR9ES
09482-00131		BP5ES
09482-00136		BPR4H
09482-00139		BP7ES
09482-00141		BPR6HS
09482-00143		BR5HS
09482-00144		D8EA
09482-00147		BPR5HS
09482-00149		DR8ESL
09482-00155		BPR5ES
09482-00157		BR8HS
09482-00163		BP5HA
09482-00175		BP8ES
09482-00177		BP6ES
09482-00181		BR10EV
09482-00182		D7EA
09482-00184		D9EA
09482-00198		B8HS
09482-00205		BPR4HS
09482-00208		B8EGV
09482-00209		B9EGV
09482-00210		B10EGV
09482-00220		DR7ES
09482-00221		DR8ES
09482-00229		BPR6ES
09482-00230		BR8HS 0,8
09482-00237		B8HS
09482-00239		BPR8ES
09482-00255		BPR7HS
09482-00258		BPMR6A
09482-00259		BP6HS
09482-00261		BPMR4A
09482-00262		BP5HS-10
09482-00264		BP6HS-10
09482-00269		B7HS-10
09482-00277		BR7HS-10
09482-00278		B8HS-10
09482-00279		B8HS-10
09482-00280		BR8HS-10

SUZUKI	→	NGK
09482-00285		BPR6ES-11
09482-00287		BP5ES-11
09482-00290		BP4H
09482-00294		C6HA
09482-00299		BPR6ES
09482-00316		BPR5HS
09482-00317		C8HA
09482-00321		C8HSA
09482-00327		BR6HS-10
09482-00328		DP9EA-9
09482-00330		DPR9EA-9
09482-00332		DP8EA-9
09482-00334		DPR8EA-9
09482-00338		B6HS-10
09482-00340		CR6HS
09482-00341		BR6HS-10
09482-00348		BR8ES
09482-00349		BR9ES
09482-00351		B9ES
09482-00352		DP7EA-9
09482-00354		DPR7EA-9
09482-00358		BR4HS
09482-00359		BPR5HS
09482-00360		BR10ES
09482-00365		J9A
09482-00366		JR9A
09482-00367		BPR4HS
09482-00370		BR8HS-10
09482-00371		J10A
09482-00375		B8HS-10
09482-00380		PJR6A
09482-00381		PJR7A
09482-00384		DCP8EVX
09482-00385		BP7ES
09482-00389		JR9B
09482-00391		JR10B
09482-00397		JR9C
09482-00398		DR7EA
09482-00399		DR8EA
09482-00400		DR9EA
09482-00401		JR8C
09482-00406		CR6HSA
09482-00408		CR7HSA
09482-00410		CR9EK
09482-00412		CR8EK
09482-00414		CR7EK
09482-00426		BK6E
09482-00427		BKR6E
09482-00432		BPR5E
09482-00433		BPR5EY-11
09482-00446		DCPR6E
09482-00448		DCPR7E



SUZUKI	→	NGK
09482-00450		DCPR8E
09482-00456		CR8E
09482-00458		CR9E
09482-00460		CR10E
09482-00462		CR10EK
09482-00463		CR10EK
09482-00464		BR8HCS-10
09482-00467		BR9HS-10
09482-00470		BR8ECM
09482-00472		BR9ECM
09482-00474		BR10ECM
09482-00477		BKR5E
09482-00478		B10ES
09482-00479		DCPR7EVX
09482-00481		DCPR8EVX
09482-00485		CR8HSA
09482-00486		BR8HCS-10
09482-00487		BPR6ES
09482-00491		JR9B
09482-00493		BPR5E-11
09482-00494		BKR6E-11
09482-00495		BPR7ES
09482-00499		R 4118-S8
09482-00500		R 4118-S9
09482-00504		BPR5EY
09482-00509		R 6918B-8
09482-00511		R 6918B-7
09482-00513		R0045J-10
09482-00514		R0045J-11
09482-00516		CR7E
09482-00519		BR9EYA
09482-00521		PGR5A
09482-00522		BPR7HS-10
09482-00523		BPR8HS
09482-00526		BR10EYA
09482-00528		CR6E
09482-00530		BPR6HS
09482-00531		BP6HS
09482-00532		B7HS-10
09482-00533		BR7HS-10
09482-00534		B6HS-10
09482-00535		BR6HS-10
09482-00537		DCPR9EVX
09482-00547		IFR5E-11
09482-00548		IFR6E-11
09482-00549		IFR5J-11
09482-00550		IFR6J-11
09482-00561		BR8EG
09482-00564		BR9EYA
09482-00584		CR8EIB-10
09482-69001		BPR6HS

YAMAHA	→	NGK
90793 20029		B95EGV
90793 20030		B105EGV
90793 20032		B10EG
90890 78082		B10EGV
94701 00039		B6HS
94701 00040		B7HS
94701 00041		B8HS
94701 00042		B9HS
94701 00043		B6ES
94701 00044		B7ES
94701 00045		B8ES
94701 00046		B9ES
94701 00048		B8HCS
94701 00050		BP7HS
94701 00061		B8EVX
94701 00063		B9EVX
94701 00069		B5HS
94701 00078		B5ES
94701 00108		BP6HS
94701 00110		BR7HS
94701 00111		BR6ES
94701 00112		BR7ES
94701 00113		BR8EVX
94701 00116		BP6ES
94701 00117		BP7ES
94701 00118		BP8ES
94701 00148		B8HVX
94701 00157		D8EA
94701 00159		BP4HS
94701 00160		B8HS-10
94701 00168		BP5HS
94701 00188		BR9ES
94701 00189		D7EA
94701 00190		BP5HA
94701 00193		BR9EVX
94701 00194		BPR5HS
94701 00195		BR8HS
94701 00198		BPR6HS
94701 00203		DR8ESL
94701 00204		BR8ES
94701 00208		DR7ES
94701 00217		B7HS-10
94701 00218		BPR7ES
94701 00219		BPR8ES
94701 00227		BPR7HS
94701 00232		BP6HS-10
94701 00234		BPR6ES
94701 00237		BP8HS-10
94701 00241		DPR8EA-9
94701 00248		BR6HS
94701 00250		CR7HS
94701 00251		BR9HS



B10EG	APRILIA, KTM, YAMAHA
B10EGV	GAS GAS, SIMONINI IMEA
B10ES	BETA, GARELLI
B4H	PUCH, RIXE, VELOSOLEX
B5ES	BULTACO
B5HS	BULTACO, FANTIC, GILERA, GIMSON, HERCULES, KTM, LEM, MARS, OMER, PEUGEOT, PUCH, RIEJU, RIZZATO, SACHS, TESTI, TORROT
B6ES	BETA, CARABELA, GILERA, KAWASAKI, LEM, MINARELLI, MOTOR HISPANIA, RIEJU, TESTI
B6HS	BATAVUS, BENELLI, BMW, BOOM TRIKE, BULTACO, CARABELA, CZ, DUCATI, DUCSON, ENFIELD, ERING, FANTIC, G.A.C. MobyLe., GARELLI, GILERA, HERCULES, HUSQVARNA, JAWA, KTM, LAMBRETTA, MALAGUTI, MBK, MECATECNO, MINARELLI, MONTESA, MOTO GUZZI, MOTOR HISPANIA, OMER, PEUGEOT, POLINI, PUCH, RIEJU, RIXE, RIZZATO, S.I.S., SACHS, SPARTA, STARFLITE, TESTI, TORROT, VELOSOLEX, YAMAHA
B6L	HARLEY-DAVIDSON
B7ES	B.S.A, BENELLI, CARABELA, GILERA, KAWASAKI, LAMBRETTA, MALAGUTI, MINARELLI, MONTESA, MOTO GUZZI, SUZUKI, YAMAHA
B7HS	ATK, BENELLI, BETA, BOOM TRIKE, BULTACO, CASAL, DERBI, DKW, DUCATI, FANTIC, G.A.C. MobyLe., HERCULES, KAWASAKI, KTM, LEM, MBK, MONDIAL, MONTESA, MOTOR HISPANIA, PEUGEOT, REGENT, RIXE, S.I.S., SACHS, SUZUKI, TOMOS, TORROT, YAMAHA
B8EG	FANTIC, HUSQVARNA, YAMAHA
B8ES	ALFER, B.S.A, BENELLI, BETA, BULTACO, CAGIVA, CARABELA, DERBI, ENFIELD, FANTIC, GILERA, HARLEY-DAVIDSON, HM RACING, KAWASAKI, LAVERDA, MBK, MINARELLI, MONTESA, MOTO GUZZI, MV AGUSTA, OSSA, PEUGEOT, PUCH, RIZZATO, SUZUKI, TESTI, TRIUMPH, YAMAHA, ZÜNDAPP

B8HS	BMW, CASAL, DERBI, FITE (LEM), GAS GAS, HERCULES, HM RACING, JAWA, KAWASAKI, KTM, MALAGUTI, MBK, MONDIAL, MONTESA, MZ, MZ (TR), PEUGEOT, PUCH, RIXE, S.I.S., SACHS, SIMONINI IMEA, SIMSON, SUZUKI, TESTI, YAMAHA, ZÜNDAPP
B9EG	APRILIA, BULTACO, CAGIVA, CCM, FANTIC, GILERA, HUSQVARNA, KAWASAKI, KTM, TM, YAMAHA
B9ES	APRILIA, BETA, BLATA, BULTACO, CAGIVA, DERBI, GILERA, HARLEY-DAVIDSON, HERCULES, HUSQVARNA, KTM, MAICO, MALAGUTI, MONTESA, MOTO GUZZI, OSSA, PUCH, SACHS, YAMAHA
B9HCS	KTM
B9HS	BULTACO, KAWASAKI, KTM, PUCH
BCP7ET	BMW
BCPR6ET	MZ
BKR5E	POLARIS
BKR6E-11	HONDA
BKR7E	POLARIS
BKR7EKC	BMW, G+G
BKR7EKC + DCPR8EKC	BMW
BP4H	SUZUKI
BP4HS	DNEPR, URAL, YAMAHA
BP5ES	APRILIA, BULTACO, CCM, GAS GAS, HARLEY-DAVIDSON, MECATECNO, MERLIN, MONTESA, OSSA, SCORPA, SHERCO, SWM
BP5ESA	BOOM TRIKE
BP5HS	CARABELA
BP6ES	BMW, DNEPR, KTM, LEM, MBK, MOTO GUZZI, MOTO-SPEZIAL, SANGLAS, SUZUKI, YAMAHA
BP6HS	ISCH, KTM, MOTOTECHNIKA, MZ, SUZUKI, YAMAHA



BP6HS-10	YAMAHA
BP6HSA	KUANG YANG
BP7ES	BETA, BMW, JCM, KAWASAKI, MOTO GUZZI, MOTO MORINI, SUZUKI, YAMAHA
BP7HS	CAGIVA, DRR, DUCATI, HERCULES, HYOSUNG, ISCH, MINSK, SACHS, URAL AMERICA, YAMAHA, ZID
BP7HS-10	YAMAHA
BP8ES	MOTO GUZZI, MOTO MORINI, MUNCH, SUZUKI, YAMAHA
BPM6A	SV
BPR4HS	KAWASAKI, SUZUKI
BPR5ES	BULTACO, GAS GAS, KAWASAKI, TITAN
BPR5ES-11	HARLEY-DAVIDSON, INDIAN
BPR5HS	HONDA
BPR6ES	GAS GAS, KAWASAKI, MOTO GUZZI, YAMAHA
BPR6HS	HONDA, PEUGEOT, SIAMOTO, SUZUKI, YAMAHA
BPR6HSA	HONDA
BPR7ES	MONTESA, YAMAHA
BPR7HS	AEON, BOMBARDIER, BSM, DAREN, DUCATI, E-TON, FOX, SUZUKI, TGB, YAMAHA
BPR8ES	KAWASAKI, YAMAHA
BR10EG	APRILIA, HONDA, KTM
BR10ES	KAWASAKI, SUZUKI
BR2LM	TRAILSPORT
BR5HS	SACHS
BR6ES	ENFIELD, HONDA, KAWASAKI, YAMAHA
BR6HS	COSSACK, ENFIELD, HONDA, SOLO, YAMAHA
BR6HSA	HONDA

BR7ES	CPI, KAWASAKI, KTM
BR7HS	BETA, DUCATI, HONDA, SOLO, SUZUKI, YAMAHA
BR8ECM	KTM
BR8EG	GAS GAS, HONDA, HUSQVARNA, KTM, TM
BR8ES	ALFER, APRILIA, HONDA, HRD, KAWASAKI, MOTO GUZZI, POLARIS, RIEJU, SACHS, SHERCO- HRD, SUZUKI, YAMAHA
BR8HS	HONDA, KTM, UNISOM, YAMAHA
BR8HSA	CPI, SAN YANG
BR9ECM	YAMAHA
BR9ECS	BOMBARDIER, HONDA
BR9EG	CAGIVA, HONDA, HUSQVARNA, YAMAHA
BR9ES	CAGIVA, GILERA, HONDA, HUSQVARNA, KAWASAKI, MOTOR HISPANIA, SACHS, SUZUKI, YAMAHA
BR9HS	HONDA, YAMAHA
C6HSA	KAWASAKI, YAMAHA
C7E	BENELLI, HUSQVARNA
C7HSA	XING FU, YAMAHA
C8E	HUSABERG, NORTON
C8EH-9	DAELIM
C8HSA	MOTO GUZZI
CR10EK	SUZUKI, YAMAHA
CR6E	ARCTIC CAT, SUZUKI
CR6HS	HONDA, YAMAHA
CR6HSA	HONDA, PANDA, YAMAHA
CR7E	ARCTIC CAT, KAWASAKI, SUZUKI, YAMAHA
CR7EB	HUSQVARNA



CR7HS	AEON, HONDA, YAMAHA
CR7HSA	BOMBARDIER, HONDA, YAMAHA
CR8E	ARCTIC CAT, BOMBARDIER, CAGIVA, GAS GAS, HYOSUNG, KAWASAKI, MZ, SUZUKI, TM, YAMAHA
CR8EB	HUSQVARNA
CR8EH-9	HONDA, HYOSUNG
CR8EH-9S	HONDA, CAGIVA, KTM, SUZUKI, VOR
CR8HS	HONDA, KARCHER
CR8HSA	AEON, KAWASAKI
CR9E	ALFER, BENELLI, BIMOTA, DERBI, KAWASAKI, SUZUKI, YAMAHA
CR9EB	GILERA, HRD
CR9EH-9	HONDA
CR9EK	BETA, BIMOTA, CANNONDALE, KAWASAKI, SUZUKI, TRIUMPH, VERTEMATI, YAMAHA
CR9EKB	MV AGUSTA
D7EA	BMW, SUZUKI, YAMAHA
D8EA	APRILIA, ATK, BENELLI, BMW, GILERA, KAWASAKI, KTM, MOTO GUZZI, MZ, SUZUKI, YAMAHA
D9EA	KAWASAKI, LAVERDA, SUZUKI
DCPR6E	HONDA
DCPR7E	BMW, BUELL, HARLEY-DAVIDSON
DCPR8E	BOMBARDIER, DUCATI, HUSABERG, KTM
DCPR9E	APRILIA, BUELL
DP7EA-9	SUZUKI
DP8EA-9	CAGIVA, YAMAHA
DP9EA-9	GILERA, KTM, PUCH
DPR5EA-9	KAWASAKI

DPR6EA-9	HONDA, KAWASAKI
DPR7EA-9	HONDA, KAWASAKI, KYMCO, SUZUKI, YAMAHA
DPR8EA-9	BIMOTA, CAGIVA, DERBI, DUCATI, HONDA, KAWASAKI, KTM, LAVERDA, SUZUKI, TRIUMPH, YAMAHA
DPR8Z	HONDA
DPR9EA-9	CAGIVA, HONDA, KAWASAKI, LAVERDA, MZ, SUZUKI, YAMAHA
DPR9Z	HONDA
DR7EA	ARCTIC CAT, BMW, YAMAHA
DR7ES	HONDA, KAWASAKI, SUZUKI, YAMAHA
DR8EA	APRILIA, BETA, BIMOTA, BOMBARDIER, CCM, DAREN, HONDA, HYOSUNG, KAWASAKI, KTM, KYMCO, REX, SUZUKI, YAMAHA
DR8EB	BMW
DR8ES	AJP, HONDA, KAWASAKI, SUZUKI
DR8ESL	BIMOTA, HONDA, KAWASAKI, SUZUKI, YAMAHA
DR9EA	KAWASAKI, KTM
JR9B	SUZUKI
JR9C	SUZUKI
PTR5A-13	BOOM TRIKE
R0045J-10	HUSQVARNA
R2270-9	DUCATI
R6179A-105P	YAMAHA
R6252K-105	KAWASAKI
R6918B-8	KTM
R7234-10	KTM
R7376-10	YAMAHA
XR5	HARLEY-DAVIDSON



B10ES	GARELLI
B5HS	PIAGGIO
B6ES	PIAGGIO
B6HS	BAJAJ, BENELLI, ERING, PIAGGIO, WINKING
B7ES	PIAGGIO
B7HS	ATALA, CAGIVA, ITALJET, PEUGEOT, PIAGGIO, SACHS
B8ES	PIAGGIO
B8HS	CAGIVA, DAELIM, DERBI, PEUGEOT, SACHS, SIMSON
B9ES	CAGIVA, DERBI, GILERA, PIAGGIO
B9HS	SIMSON
BP5HS	BAJAJ
BP6HS	BAJAJ, CAGIVA, HYOSUNG, ITALJET, LECSON, PEUGEOT, PGO, SACHS, STEFFEN, T.G.M. Bimota, TGB
BP7HS	CCF, FANTIC, GARELLI, ITALJET, KINETIC, MARS, MBK, PGO, SHE LUNG, TOKAIDO, YAMAHA
BP7HS-10	MBK, YAMAHA
BP8ES	LML- VESPA, PIAGGIO
BPR5HS	BAJAJ
BPR6HS	ATALA, HONDA, ITALJET, MALAGUTI, SACHS, SASY, SIAM, SUZUKI
BPR6HSA	HONDA
BPR7HS	GARELLI, KREIDLER, MBK, PEGASUS, PGO, REX, SUZUKI
BPR8ES	PIAGGIO
BPR8HS	APRILIA, ITALJET
BR10ES	DERBI

BR6HS	PIAGGIO
BR6HSA	HONDA
BR7ES	CPI, PIAGGIO
BR7HS	APRILIA, BENELLI, BETA, BUFFALO, ITALJET, KTM, K-ZWO, LEM, MACAL, MALAGUTI, MBK, MOTRON, MZ, PEUGEOT, PIAGGIO, SACHS, YAMAHA
BR8ES	HONDA, PEUGEOT, PIAGGIO, RIEJU
BR8HS	APRILIA, BENELLI, BETA, DERBI, ITALJET, MALAGUTI, MBK, PEUGEOT, SACHS, YAMAHA
BR8HSA	BS VILLA, CAGIVA, DAELIM, GARELLI, HYOSUNG, KYMCO, SAN YANG, SYM, VILLA BS
BR9ES	APRILIA, DERBI, GILERA, ITALJET, PIAGGIO, RIEJU
BR9HS	GARELLI
C7HSA	KYMCO, K-ZWO, PGO, SAN YANG, SIAMOTO, SYM
CPR8E	APRILIA, PEUGEOT
CR6HSA	YAMAHA
CR7E	APRILIA, CAGIVA, ITALJET, MBK, PIAGGIO, SUZUKI, YAMAHA
CR7EB	PEUGEOT, PIAGGIO
CR7EKB	APRILIA, PIAGGIO, SYM
CR7HSA	ERING, GARELLI, KREIDLER, MALAGUTI, PEGASUS, REX, RIEJU, SUNDIRO, SYM
CR8E	APRILIA, BENELLI, ITALJET, MBK, PEUGEOT, SUZUKI, YAMAHA
CR8EB	APRILIA, BENELLI, BMW, GILERA, MALAGUTI, PIAGGIO
CR8EH-9	DAELIM, HONDA
CR9E	DERBI, PIAGGIO
CR9EB	PIAGGIO
DPR6EA-9	HONDA



AEON	BPR7HS, CR7HS, CR8HSA
AJP	DR8ES
ALFER	B8ES, BR8ES, CR9E
APRILIA	B10EG, B9EG, B9ES, BP5ES, BR10EG, BR8ES, D8EA, DCPR9E, DR8EA
ARCTIC CAT	CR6E, CR7E, CR8E, DR7EA
ATK	B7HS, D8EA
B.S.A	B7ES, B8ES
BATAVUS	B6HS
BENELLI	B6HS, B7ES, B7HS, B8ES, C7E, CR9E, D8EA
BETA	B10ES, B6ES, B7HS, B8ES, B9ES, BP7ES, BR7HS, CR9EK, DR8EA
BIMOTA	CR9E, CR9EK, DPR8EA-9, DR8EA, DR8ESL
BLATA	B9ES
BMW	B6HS, B8HS, BCP7ET, BKR7EKC, BKR7EKC + DCPR8EKC, BP6ES, BP7ES, D7EA, D8EA, DCPR7E, DR7EA, DR8EB
BOMBARDIER	BPR7HS, BR9ECS, CR7HSA, CR8E, DCPR8E, DR8EA
BOOM TRIKE	B6HS, B7HS, BP5ESA, PTR5A-13
BSM	BPR7HS
BUELL	DCPR7E, DCPR9E
BULTACO	B5ES, B5HS, B6HS, B7HS, B8ES, B9EG, B9ES, B9HS, BP5ES, BPR5ES
CAGIVA	B8ES, B9EG, B9ES, BP7HS, BR9EG, BR9ES, CR8E, CR8EK, DP8EA-9, DPR8EA-9, DPR9EA-9
CANNONDALE	CR9EK
CARABELA	B6ES, B6HS, B7ES, B8ES, BP5HS
CASAL	B7HS, B8HS
CCM	B9EG, BP5ES, DR8EA

COSSACK	BR6HS
CPI	BR7ES, BR8HSA
CZ	B6HS
DAELIM	C8EH-9
DAREN	BPR7HS, DR8EA
DERBI	B7HS, B8ES, B8HS, B9ES, CR9E, DPR8EA-9
DKW	B7HS
DNEPR	BP4HS, BP6ES
DRR	BP7HS
DUCATI	---, B6HS, B7HS, BP7HS, BPR7HS, BR7HS, DCPR8E, DPR8EA-9, R2270-9
DUCCSON	B6HS
ENFIELD	B6HS, B8ES, BR6ES, BR6HS
ERING	B6HS
E-TON	BPR7HS
FANTIC	B5HS, B6HS, B7HS, B8EG, B8ES, B9EG
FITE (LEM)	B8HS
FOX	BPR7HS
G.A.C. Mobyte.	B6HS, B7HS
G+G	BKR7EKC
GARELLI	B10ES, B6HS
GAS GAS	B10EGV, B8HS, BP5ES, BPR5ES, BPR6ES, BR8EG, CR8E
GILERA	B5HS, B6ES, B6HS, B7ES, B8ES, B9EG, B9ES, BR9ES, CR9EB, D8EA, DP9EA-9
GIMSON	B5HS
HARLEY-DAVIDSON	B6L, B8ES, B9ES, BP5ES, BPR5ES-11, DCPR7E, XR5
HERCULES	B5HS, B6HS, B7HS, B8HS, B9ES, BP7HS



HM RACING	B8ES, B8HS
HONDA	BKR6E-11, BPR5HS, BPR6HS, BPR6HSA, BR10EG, BR6ES, BR6HS, BR6HSA, BR7HS, BR8EG, BR8ES, BR8HS, BR9ECS, BR9EG, BR9ES, BR9HS, CR6HS, CR6HSA, CR7HS, CR7HSA, CR8EH-9, CR8EH-9S, CR8HS, CR9EH-9, DCPR6E, DPR6EA-9, DPR7EA-9, DPR8EA-9, DPR8Z, DPR9EA-9, DPR9Z, DR7ES, DR8EA, DR8ES, DR8ESL
HRD	BR8ES, CR9EB
HUSABERG	C8E, DCPR8E
HUSQVARNA	B6HS, B8EG, B9EG, B9ES, BR8EG, BR9EG, BR9ES, C7E, CR7EB, CR8EB, R0045J-10
HYOSUNG	BP7HS, CR8E, CR8EH-9, DR8EA
INDIAN	BPR5ES-11
ISCH	BP6HS, BP7HS
JAWA	B6HS, B8HS
JCM	BP7ES
KARCHER	CR8HS
KAWASAKI	B6ES, B7ES, B7HS, B8ES, B8HS, B9EG, B9HS, BP7ES, BPR4HS, BPR5ES, BPR6ES, BPR8ES, BR10ES, BR6ES, BR7ES, BR8ES, BR9ES, C6HSA, CR7E, CR8E, CR8HSA, CR9E, CR9EK, D8EA, D9EA, DPR5EA-9, DPR6EA-9, DPR7EA-9, DPR8EA-9, DPR9EA-9, DR7ES, DR8EA, DR8ES, DR8ESL, DR9EA, R6252K-105
KTM	B10EG, B5HS, B6HS, B7HS, B8HS, B9EG, B9ES, B9HCS, B9HS, BP6ES, BP6HS, BR10EG, BR7ES, BR8ECM, BR8EG, BR8HS, CR8EK, D8EA, DCPR8E, DP9EA-9, DPR8EA-9, DR8EA, DR9EA, R6918B-8, R7234-10
KUANG YANG	BP6HSA
KYMCO	DPR7EA-9, DR8EA
LAMBRETTA	B6HS, B7ES
LAVERDA	B8ES, D9EA, DPR8EA-9, DPR9EA-9
LEM	B5HS, B6ES, B7HS, BP6ES

MAICO	B9ES
MALAGUTI	B6HS, B7ES, B8HS, B9ES
MARS	B5HS
MBK	B6HS, B7HS, B8ES, B8HS, BP6ES
MECATECNO	B6HS, BP5ES
MERLIN	BP5ES
MINARELLI	B6ES, B6HS, B7ES, B8ES
MINSK	BP7HS
MONDIAL	B7HS, B8HS
MONTESA	B6HS, B7ES, B7HS, B8ES, B8HS, B9ES, BP5ES, BPR7ES
MOTO GUZZI	B6HS, B7ES, B8ES, B9ES, BP6ES, BP7ES, BP8ES, BPR6ES, BR8ES, C8HSA, D8EA
MOTO MORINI	BP7ES, BP8ES
MOTOR HISPANIA	B6ES, B6HS, B7HS, BR9ES
MOTO-SPEZIAL	BP6ES
MOTOTECHNIKA	BP6HS
MÜNCH	BP8ES
MV AGUSTA	B8ES, CR9EKB
MZ	B8HS, BCPR6ET, BP6HS, CR8E, D8EA, DPR9EA-9
MZ (TR)	B8HS
NORTON	C8E
OMER	B5HS, B6HS
OSSA	B8ES, B9ES, BP5ES
PANDA	CR6HSA
PEUGEOT	B5HS, B6HS, B7HS, B8ES, B8HS, BPR6HS
POLARIS	BKR5E, BKR7E, BR8ES
POLINI	B6HS



PUCH	B4H, B5HS, B6HS, B8ES, B8HS, B9ES, B9HS, DP9EA-9
REGENT	B7HS
REX	DR8EA
RIEJU	B5HS, B6ES, B6HS, BR8ES
RIXE	B4H, B6HS, B7HS, B8HS
RIZZATO	B5HS, B6HS, B8ES
S.I.S.	B6HS, B7HS, B8HS
SACHS	B5HS, B6HS, B7HS, B8HS, B9ES, BP7HS, BR5HS, BR8ES, BR9ES
SAN YANG	BR8HSA
SANGLAS	BP6ES
SCORPA	BP5ES
SHERCO	BP5ES
SHERCO- HRD	BR8ES
SIAMOTO	BPR6HS
SIMONINI IMEA	B10EGV, B8HS
SIMSON	B8HS
SOLO	BR6HS, BR7HS
SPARTA	B6HS
STARFLITE	B6HS
SUZUKI	B7ES, B7HS, B8ES, B8HS, BP4H, BP6ES, BP6HS, BP7ES, BP8ES, BPR4HS, BPR6HS, BPR7HS, BR10ES, BR7HS, BR8ES, BR9ES, CR10EK, CR6E, CR7E, CR8E, CR8EK, CR9E, CR9EK, D7EA, D8EA, D9EA, DP7EA-9, DPR7EA-9, DPR8EA-9, DPR9EA-9, DR7ES, DR8EA, DR8ES, DR8ESL, JR9B, JR9C
SV	BPM6A
SWM	BP5ES
TESTI	B5HS, B6ES, B6HS, B8ES, B8HS

TGB	BPR7HS
TITAN	BPR5ES
TM	B9EG, BR8EG, CR8E
TOMOS	B7HS
TORROT	B5HS, B6HS, B7HS
TRAILSPORT	BR2LM
TRIUMPH	B8ES, CR9EK, DPR8EA-9
UNISOM	BR8HS
URAL	BP4HS
URAL AMERICA	BP7HS
VELOSOLEX	B4H, B6HS
VERTEMATI	CR9EK
VOR	CR8EK
XING FU	C7HSA
YAMAHA	B10EG, B6HS, B7ES, B7HS, B8EG, B8ES, B8HS, B9EG, B9ES, BP4HS, BP6ES, BP6HS, BP6HS-10, BP7ES, BP7HS, BP7HS-10, BP8ES, BPR6ES, BPR6HS, BPR7ES, BPR7HS, BPR8ES, BR6ES, BR6HS, BR7HS, BR8ES, BR8HS, BR9ECM, BR9EG, BR9ES, BR9HS, C6HSA, C7HSA, CR10EK, CR6HS, CR6HSA, CR7E, CR7HS, CR7HSA, CR8E, CR9E, CR9EK, D7EA, D8EA, DP8EA-9, DPR7EA-9, DPR8EA-9, DPR9EA-9, DR7EA, DR7ES, DR8EA, DR8ESL, R6179A-10SP, R7376-10
ZID	BP7HS
ZÜNDAPP	B8ES, B8HS



APRILIA	BPR8HS, BR7HS, BR8HS, BR9ES, CPR8E, CR7E, CR7EKB, CR8E, CR8EB, DR8EA
ATALA	B7HS, BPR6HS
BAJAJ	B6HS, BP5HS, BP6HS, BPR5HS
BENELLI	B6HS, BR7HS, BR8HS, CR8E, CR8EB
BETA	BR7HS, BR8HS, DR8EA
BMW	CR8EB
BS VILLA	BR8HSA
BUFFALO	BR7HS
CAGIVA	B7HS, B8HS, B9ES, BP6HS, BR8HSA, CR7E
CCF	BP7HS
CPI	BR7ES
DAELIM	B8HS, BR8HSA, CR8EH-9
DERBI	B8HS, B9ES, BR10ES, BR8HS, BR9ES, CR9E
ERING	B6HS, CR7HSA
FANTIC	BP7HS
GARELLI	B10ES, BP7HS, BPR7HS, BR8HSA, BR9HS, CR7HSA
GILERA	B9ES, BR9ES, CR8EB
HONDA	BPR6HS, BPR6HSA, BR6HSA, BR8ES, CR8EH-9, DPR6EA-9, DPR7EA-9, ER8EH-N
HYOSUNG	BP6HS, BR8HSA, DR8EA
ITALJET	B7HS, BP6HS, BP7HS, BPR6HS, BPR8HS, BR7HS, BR8HS, BR9ES, CR7E, CR8E, DR8EA
KINETIC	BP7HS
KREIDLER	BPR7HS, CR7HSA
KTM	BR7HS
KYMCO	BR8HSA, C7HSA, DPR7EA-9, DR8EA
K-ZWO	BR7HS, C7HSA

LECSO	BP6HS
LEM	BR7HS
LML- VESPA	BP8ES
MACAL	BR7HS
MALAGUTI	BPR6HS, BR7HS, BR8HS, CR7HSA, CR8EB
MARS	BP7HS
MBK	BP7HS, BP7HS-10, BPR7HS, BR7HS, BR8HS, CR7E, CR8E
MOTRON	BR7HS
MZ	BR7HS
PEGASUS	BPR7HS, CR7HSA
PEUGEOT	B7HS, B8HS, BP6HS, BR7HS, BR8ES, BR8HS, CPR8E, CR7EB, CR8E
PGO	BP6HS, BP7HS, BPR7HS, C7HSA
PIAGGIO	---, B5HS, B6ES, B6HS, B7ES, B7HS, B8ES, B9ES, BP8ES, BPR8ES, BR6HS, BR7ES, BR7HS, BR8ES, BR9ES, CR7E, CR7EB, CR7EKB, CR8EB, CR9E, CR9EB
REX	BPR7HS, CR7HSA
RIEJU	BR8ES, BR9ES, CR7HSA
SACHS	B7HS, B8HS, BP6HS, BPR6HS, BR7HS, BR8HS
SAN YANG	BR8HSA, C7HSA
SASY	BPR6HS
SHE LUNG	BP7HS
SIAM	BPR6HS
SIAMOTO	C7HSA
SIMSON	B8HS, B9HS
STEFFEN	BP6HS
SUNDIRO	---, CR7HSA

Quick-No.

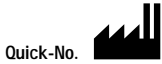

Quick-No.

201	PIAGGIO
202	CAGIVA, DERBI, GILERA, PIAGGIO
203	BAJAJ, BENELLI, ERING, PIAGGIO, WINKING
204	ATALA, CAGIVA, ITALJET, PEUGEOT, PIAGGIO, SACHS
205	CAGIVA, DAELIM, DERBI, PEUGEOT, SACHS, SIMSON
207	HONDA, PEUGEOT, PIAGGIO, RIEJU
208	APRILIA, DERBI, GILERA, ITALJET, PIAGGIO, RIEJU
209	PIAGGIO
210	HONDA
211	APRILIA, BENELLI, BETA, BUFFALO, ITALJET, KTM, K-ZWO, LEM, MACAL, MALAGUTI, MBK, MOTRON, MZ, PEUGEOT, PIAGGIO, SACHS, YAMAHA
212	APRILIA, BENELLI, BETA, DERBI, ITALJET, MALAGUTI, MBK, PEUGEOT, SACHS, YAMAHA
214	ATALA, HONDA, ITALJET, MALAGUTI, SACHS, SASY, SIAM, SUZUKI
215	GARELLI, KREIDLER, MBK, PEGASUS, PGO, REX, SUZUKI
220	HONDA, KYMCO
225	APRILIA, CAGIVA, ITALJET, MBK, PIAGGIO, SUZUKI, YAMAHA
226	APRILIA, BENELLI, ITALJET, MBK, PEUGEOT, SUZUKI, YAMAHA
227	DERBI, PIAGGIO
228	DAELIM, HONDA



Quick-No.

205	BMW, CASAL, DERBI, FITE (LEM), GAS GAS, HERCULES, HM RACING, JAWA, KAWASAKI, KTM, MALAGUTI, MBK, MONDIAL, MONTESA, MZ, MZ (TR), PEUGEOT, PUCH, RIXE, S.I.S., SACHS, SIMONINI IMEA, SIMSON, SUZUKI, TESTI, YAMAHA, ZÜNDAPP
206	BETA, BMW, JCM, KAWASAKI, MOTO GUZZI, MOTO MORINI, SUZUKI, YAMAHA
207	ALFER, APRILIA, HONDA, HRD, KAWASAKI, MOTO GUZZI, POLARIS, RIEJU, SACHS, SHERCO- HRD, SUZUKI, YAMAHA
208	CAGIVA, GILERA, HONDA, HUSQVARNA, KAWASAKI, MOTOR HISPANIA, SACHS, SUZUKI, YAMAHA
209	COSSACK, ENFIELD, HONDA, SOLO, YAMAHA
210	HONDA
211	BETA, DUCATI, HONDA, SOLO, SUZUKI, YAMAHA
212	HONDA, KTM, UNISOM, YAMAHA
213	KAWASAKI, YAMAHA
214	HONDA, PEUGEOT, SIAMOTO, SUZUKI, YAMAHA
215	AEON, BOMBARDIER, BSM, DAREN, DUCATI, E-TON, FOX, SUZUKI, TGB, YAMAHA
216	APRILIA, ATK, BENELLI, BMW, GILERA, KAWASAKI, KTM, MOTO GUZZI, MZ, SUZUKI, YAMAHA
217	AJP, HONDA, KAWASAKI, SUZUKI
218	BIMOTA, HONDA, KAWASAKI, SUZUKI, YAMAHA
219	KAWASAKI, KTM
220	HONDA, KAWASAKI, KYMCO, SUZUKI, YAMAHA
221	BIMOTA, CAGIVA, DERBI, DUCATI, HONDA, KAWASAKI, KTM, LAVERDA, SUZUKI, TRIUMPH, YAMAHA
222	CAGIVA, HONDA, KAWASAKI, LAVERDA, MZ, SUZUKI, YAMAHA
223	HONDA, YAMAHA
224	SUZUKI
225	ARCTIC CAT, KAWASAKI, SUZUKI, YAMAHA
226	ARCTIC CAT, BOMBARDIER, CAGIVA, GAS GAS, HYOSUNG, KAWASAKI, MZ, SUZUKI, TM, YAMAHA
227	ALFER, BIMOTA, DERBI, HONDA, KAWASAKI, SUZUKI, YAMAHA
228	HONDA, HYOSUNG
229	HONDA
230	BETA, BIMOTA, CANNONDALE, KAWASAKI, SUZUKI, TRIUMPH, VERTEMATI, YAMAHA
310	TRAILSPOORT



Quick-No.

201	ALFER, B.S.A, BENELLI, BETA, BULTACO, CAGIVA, CARABELA, DERBI, ENFIELD, FANTIC, GILERA, HARLEY-DAVIDSON, HM RACING, KAWASAKI, LAVERDA, MBK, MINARELLI, MONTESA, MOTO GUZZI, MV AGUSTA, OSSA, PEUGEOT, PUCH, RIZZATO, SUZUKI, TESTI, TRIUMPH, YAMAHA, ZÜNDAPP
202	APRILIA, BETA, BLATA, BULTACO, CAGIVA, DERBI, GILERA, HARLEY-DAVIDSON, HERCULES, HUSQVARNA, KTM, MAICO, MALAGUTI, MONTESA, MOTO GUZZI, OSSA, PUCH, SACHS, YAMAHA
203	BATAVUS, BENELLI, BMW, BOOM TRIKE, BULTACO, CARABELA, CZ, DUCATI, DUCSON, ENFIELD, ERING, FANTIC, G.A.C. MobyLe., GARELLI, GILERA, HERCULES, HUSQVARNA, JAWA, KTM, LAMBRETTA, MALAGUTI, MBK, MECATECNO, MINARELLI, MONTESA, MOTO GUZZI, MOTOR HISPANIA, OMER, PEUGEOT, POLINI, PUCH, RIEJU, RIXE, RIZZATO, S.I.S., SACHS, SPARTA, STARFLITE, TESTI, TORROT, VELOSOLEX, YAMAHA
204	ATK, BENELLI, BETA, BOOM TRIKE, BULTACO, CASAL, DERBI, DKW, DUCATI, FANTIC, G.A.C. MobyLe., HERCULES, KAWASAKI, KTM, LEM, MBK, MONDIAL, MONTESA, MOTOR HISPANIA, PEUGEOT, REGENT, RIXE, S.I.S., SACHS, SUZUKI, TOMOS, TORROT, YAMAHA

Quick-No.



Quick-No.



AEON	215
AJP	217
ALFER	201, 207, 227
APRILIA	202, 207, 216
ARCTIC CAT	225, 226
ATK	204, 216
B.S.A	201
BATAVUS	203
BENELLI	201, 203, 204, 216
BETA	201, 202, 204, 206, 211, 230
BIMOTA	218, 221, 227, 230
BLATA	202
BMW	203, 205, 206, 216
BOMBARDIER	215, 226
BOOM TRIKE	203, 204
BSM	215
BULTACO	201, 202, 203, 204
CAGIVA	201, 202, 208, 221, 222, 226
CANNONDALE	230
CARABELA	201, 203
CASAL	204, 205
COSSACK	209
CZ	203
DAREN	215
DERBI	201, 202, 204, 205, 221, 227
DKW	204
DUCATI	203, 204, 211, 215, 221



Quick-No.



DUCCSON	203
ENFIELD	201, 203, 209
ERING	203
E-TON	215
FANTIC	201, 203, 204
FITE (LEM)	205
FOX	215
G.A.C. MobyLe.	203, 204
GARELLI	203
GAS GAS	205, 226
GILERA	201, 202, 203, 208, 216
HARLEY-DAVIDSON	201, 202
HERCULES	202, 203, 204, 205
HM RACING	201, 205
HONDA	207, 208, 209, 210, 211, 212, 214, 217, 218, 220, 221, 222, 223, 227, 228, 229
HRD	207
HUSQVARNA	202, 203, 208
HYOSUNG	226, 228
JAWA	203, 205
JCM	206
KAWASAKI	201, 204, 205, 206, 207, 208, 213, 216, 217, 218, 219, 220, 221, 222, 225, 226, 227, 230
KTM	202, 203, 204, 205, 212, 216, 219, 221
KYMCO	220
LAMBRETTA	203
LAVERDA	201, 221, 222
LEM	204

Quick-No.



Quick-No.



MAICO	202
MALAGUTI	202, 203, 205
MBK	201, 203, 204, 205
MECATECNO	203
MINARELLI	201, 203
MONDIAL	204, 205
MONTESA	201, 202, 203, 204, 205
MOTO GUZZI	201, 202, 203, 206, 207, 216
MOTO MORINI	206
MOTOR HISPANIA	203, 204, 208
MV AGUSTA	201
MZ	205, 216, 222, 226
MZ (TR)	205
OMER	203
OSSA	201, 202
PEUGEOT	201, 203, 204, 205, 214
POLARIS	207
POLINI	203
PUCH	201, 202, 203, 205
REGENT	204
RIEJU	203, 207
RIXE	203, 204, 205
RIZZATO	201, 203
S.I.S.	203, 204, 205
SACHS	202, 203, 204, 205, 207, 208
SHERCO- HRD	207
SIAMOTO	214



Quick-No.



SIMONINI IMEA	205
SIMSON	205
SOLO	209, 211
SPARTA	203
STARFLITE	203
SUZUKI	201, 204, 205, 206, 207, 208, 211, 214, 215, 216, 217, 218, 220, 221, 222, 224, 225, 226, 227, 230
TESTI	201, 203, 205
TGB	215
TM	226
TOMOS	204
TORROT	203, 204
TRAILSPORT	310
TRIUMPH	201, 221, 230
UNISOM	212
VELOSOLEX	203
VERTEMATI	230
YAMAHA	201, 202, 203, 204, 205, 206, 207, 208, 209, 211, 212, 213, 214, 215, 216, 218, 220, 221, 222, 223, 225, 226, 227, 230
ZÜNDAPP	201, 205



BKR5EIX	POLARIS
BKR6EIX-11	HONDA
BKR7EIX	POLARIS
BPR5EIX	APRILIA, BOOM TRIKE, BULTACO, CCM, GAS GAS, HARLEY-DAVIDSON, KAWASAKI, MECATECNO, MERLIN, MONTESA, OSSA, SCORPA, SHERCO, SWM, TITAN
BPR5EIX-11	HARLEY-DAVIDSON, INDIAN
BPR6EIX	BMW, DNEPR, GAS GAS, KAWASAKI, KTM, LEM, MBK, MOTO GUZZI, MOTO-SPEZIAL, SANGLAS, SUZUKI, YAMAHA
BPR6HIX	HONDA, ISCH, KTM, KUANG YANG, MOTOTECHNIKA, MZ, PEUGEOT, SIAMOTO, SUZUKI, YAMAHA
BPR7EIX	BETA, BMW, JCM, KAWASAKI, MONTESA, MOTO GUZZI, MOTO MORINI, SUZUKI, YAMAHA
BPR7HIX	AEON, BOMBARDIER, BSM, CAGIVA, DAREN, DRR, DUCATI, E-TON, FOX, HERCULES, HYOSUNG, ISCH, MINSK, SACHS, SUZUKI, TGB, URAL AMERICA, YAMAHA, ZID
BPR8HIX	YAMAHA
BR10EIX	BETA, GARELLI, KAWASAKI, SUZUKI, YAMAHA
BR6HIX	BATAVUS, BENELLI, BMW, BOOM TRIKE, BULTACO, CARABELA, COSSACK, CZ, DUCATI, DUCSON, ENFIELD, ERING, FANTIC, G.A.C. MobyLe., GARELLI, GILERA, HERCULES, HONDA, HUSQVARNA, JAWA, KTM, LAMBRETTA, MALAGUTI, MBK, MECATECNO, MINARELLI, MONTESA, MOTO GUZZI, MOTOR HISPANIA, OMER, PEUGEOT, POLINI, PUCH, RIEJU, RIXE, RIZZATO, S.I.S., SACHS, SOLO, SPARTA, STARFLITE, TESTI, TORROT, VELOSOLEX, YAMAHA
BR7HIX	ATK, BENELLI, BETA, BOOM TRIKE, BULTACO, CASAL, DERBI, DKW, DUCATI, FANTIC, G.A.C. MobyLe., HERCULES, HONDA, KAWASAKI, KTM, LEM, MBK, MONDIAL, MONTESA, MOTOR HISPANIA, PEUGEOT, POLINI, REGENT, RIXE, S.I.S., SACHS, SOLO, SUZUKI, TOMOS, TORROT, YAMAHA

BR8EIX	ALFER, APRILIA, B.S.A, BENELLI, BETA, BULTACO, CAGIVA, CARABELA, CCM, DERBI, ENFIELD, FANTIC, GILERA, HARLEY-DAVIDSON, HM RACING, HONDA, HRD, KAWASAKI, KTM, LAVERDA, MBK, MINARELLI, MONTESA, MOTO GUZZI, MV AGUSTA, OSSA, PEUGEOT, POLARIS, PUCH, RIEJU, RIZZATO, SACHS, SHERCO- HRD, SUZUKI, TESTI, TRIUMPH, YAMAHA, ZUNDAPP
BR8HIX	BMW, CASAL, CPI, DERBI, FITE (LEM), GAS GAS, HERCULES, HM RACING, HONDA, JAWA, KAWASAKI, KTM, MALAGUTI, MBK, MONDIAL, MONTESA, MZ, MZ (TR), PEUGEOT, PUCH, RIXE, S.I.S., SACHS, SAN YANG, SIMONINI IMEA, SIMSON, SUZUKI, TESTI, UNISOM, YAMAHA, ZUNDAPP
BR9EIX	APRILIA, BETA, BLATA, BULTACO, CAGIVA, CCM, DERBI, FANTIC, GAS GAS, GILERA, HARLEY-DAVIDSON, HERCULES, HONDA, HUSQVARNA, KAWASAKI, KTM, MAICO, MALAGUTI, MONTESA, MOTO GUZZI, MOTOR HISPANIA, OSSA, PUCH, SACHS, SUZUKI, TM, YAMAHA
CR10EIX	SUZUKI, YAMAHA
CR6HIX	HONDA, KAWASAKI, PANDA, SUZUKI, YAMAHA
CR7EIX	ARCTIC CAT, BENELLI, HUSQVARNA, KAWASAKI, SUZUKI, YAMAHA
CR7HIX	AEON, BOMBARDIER, HONDA, XING FU, YAMAHA
CR8EHIX-9	DAELIM, HONDA, HYOSUNG
CR8EIX	ARCTIC CAT, BOMBARDIER, CAGIVA, GAS GAS, HUSABERG, HUSQVARNA, HYOSUNG, KAWASAKI, MZ, NORTON, SUZUKI, TM, YAMAHA
CR8HIX	AEON, HONDA, KARCHER, KAWASAKI, MOTO GUZZI
CR9EHIX-9	HONDA
CR9EIX	ALFER, BENELLI, BETA, BIMOTA, CANNONDALE, DERBI, GILERA, HRD, KAWASAKI, SUZUKI, TRIUMPH, VERTEMATI, YAMAHA
DCPR7EIX	BMW, BUELL, HARLEY-DAVIDSON, HARLEY-DAVIDSON
DCPR8EIX	BOMBARDIER, DUCATI, HUSABERG, KTM



AEON	BPR7HIX, CR7HIX, CR8HIX
AJP	DR8EIX
ALFER	BR8EIX, CR9EIX
APRILIA	BPR5EIX, BR8EIX, BR9EIX, DCPR9EIX, DR8EIX
ARCTIC CAT	CR7EIX, CR8EIX
ATK	BR7HIX, DR8EIX
B.S.A	BR8EIX
BATAVUS	BR6HIX
BENELLI	BR6HIX, BR7HIX, BR8EIX, CR7EIX, CR9EIX, DR8EIX
BETA	BPR7EIX, BR10EIX, BR7HIX, BR8EIX, BR9EIX, CR9EIX, DR8EIX
BIMOTA	CR9EIX, DPR8EIX-9, DR8EIX
BLATA	BR9EIX
BMW	BPR6EIX, BPR7EIX, BR6HIX, BR8HIX, DCPR7EIX, DR8EIX
BOMBARDIER	BPR7HIX, CR7HIX, CR8EIX, DCPR8EIX, DR8EIX
BOOM TRIKE	BPR5EIX, BR6HIX, BR7HIX
BSM	BPR7HIX
BUELL	DCPR7EIX, DCPR9EIX
BULTACO	BPR5EIX, BR6HIX, BR7HIX, BR8EIX, BR9EIX
CAGIVA	BPR7HIX, BR8EIX, BR9EIX, CR8EIX, DPR8EIX-9, DPR9EIX-9
CANNONDALE	CR9EIX
CARABELA	BR6HIX, BR8EIX
CASAL	BR7HIX, BR8HIX
CCM	BPR5EIX, BR8EIX, BR9EIX, DR8EIX
COSSACK	BR6HIX
CPI	BR8HIX

CZ	BR6HIX
DAELIM	CR8EIX-9
DAREN	BPR7HIX, DR8EIX
DERBI	BR7HIX, BR8EIX, BR8HIX, BR9EIX, CR9EIX, DPR8EIX-9
DKW	BR7HIX
DNEPR	BPR6EIX
DRR	BPR7HIX
DUCATI	---, BPR7HIX, BR6HIX, BR7HIX, DCPR8EIX, DPR8EIX-9, DR9EIX
DUCCSON	BR6HIX
EATV	DCPR8EIX
ENFIELD	BR6HIX, BR8EIX
ERING	BR6HIX
E-TON	BPR7HIX
FANTIC	BR6HIX, BR7HIX, BR8EIX, BR9EIX
FITE (LEM)	BR8HIX
FOX	BPR7HIX
G.A.C. MobyLe.	BR6HIX, BR7HIX
GARELLI	BR10EIX, BR6HIX
GAS GAS	BPR5EIX, BPR6EIX, BR8HIX, BR9EIX, CR8EIX
GILERA	BR6HIX, BR8EIX, BR9EIX, CR9EIX, DPR9EIX-9, DR8EIX
HARLEY-DAVIDSON	BPR5EIX, BPR5EIX-11, BR8EIX, BR9EIX, DCPR7EIX, XR5IX
HERCULES	BPR7HIX, BR6HIX, BR7HIX, BR8HIX, BR9EIX
HM RACING	BR8EIX, BR8HIX



HONDA	BKR6EIX-11, BPR6HIX, BR6HIX, BR7HIX, BR8EIX, BR8HIX, BR9EIX, CR6HIX, CR7HIX, CR8EHIX-9, CR8HIX, CR9EHIX-9, DPR7EIX-9, DPR8EIX-9, DPR9EIX-9, DR8EIX, IFR5L-11, IFR9H-11, IJR7A-9, IJR8B-9, IMR9C-9H, IMR9C-9HES
HRD	BR8EIX, CR9EIX
HUSABERG	CR8EIX, DCPR8EIX
HUSQVARNA	BR6HIX, BR9EIX, CR7EIX, CR8EIX
HYOSUNG	BPR7HIX, CR8EHIX-9, CR8EIX, DR8EIX
INDIAN	BPR5EIX-11
ISCH	BPR6HIX, BPR7HIX
JAWA	BR6HIX, BR8HIX, DR8EIX
JCM	BPR7EIX
KARCHER	CR8HIX
KAWASAKI	BPR5EIX, BPR6EIX, BPR7EIX, BR10EIX, BR7HIX, BR8EIX, BR8HIX, BR9EIX, CR6HIX, CR7EIX, CR8EIX, CR8HIX, CR9EIX, DPR7EIX-9, DPR8EIX-9, DPR9EIX-9, DR8EIX, DR9EIX
KTM	BPR6EIX, BPR6HIX, BR6HIX, BR7HIX, BR8EIX, BR8HIX, BR9EIX, DCPR8EIX, DPR8EIX-9, DPR9EIX-9, DR8EIX, DR9EIX
KUANG YANG	BPR6HIX
KYMCO	DPR7EIX-9, DR8EIX
LAMBRETTA	BR6HIX
LAVERDA	BR8EIX, DPR8EIX-9, DPR9EIX-9, DR9EIX
LEM	BPR6EIX, BR7HIX
MAICO	BR9EIX
MALAGUTI	BR6HIX, BR8HIX, BR9EIX
MBK	BPR6EIX, BR6HIX, BR7HIX, BR8EIX, BR8HIX
MECATECNO	BPR5EIX, BR6HIX
MERLIN	BPR5EIX

MINARELLI	BR6HIX, BR8EIX
MINSK	BPR7HIX
MONDIAL	BR7HIX, BR8HIX
MONTESA	BPR5EIX, BPR7EIX, BR6HIX, BR7HIX, BR8EIX, BR8HIX, BR9EIX
MOTO GUZZI	BPR6EIX, BPR7EIX, BR6HIX, BR8EIX, BR9EIX, CR8HIX, DR8EIX, DR9EIX
MOTO MORINI	BPR7EIX
MOTOR HISPANIA	BR6HIX, BR7HIX, BR9EIX
MOTO-SPEZIAL	BPR6EIX
MOTOTECHNIKA	BPR6HIX
MV AGUSTA	BR8EIX, CR9EIX
MZ	BPR6HIX, BR8HIX, CR8EIX, DPR9EIX-9, DR8EIX
MZ (TR)	BR8HIX
NORTON	CR8EIX
OMER	BR6HIX
OSSA	BPR5EIX, BR8EIX, BR9EIX
PANDA	CR6HIX
PEUGEOT	BPR6HIX, BR6HIX, BR7HIX, BR8EIX, BR8HIX
POLARIS	BKR5EIX, BKR7EIX, BR8EIX
POLINI	BR6HIX, BR7HIX
PUCH	BR6HIX, BR8EIX, BR8HIX, BR9EIX, DPR9EIX-9
REGENT	BR7HIX
REX	DR8EIX
RIEJU	BR6HIX, BR8EIX
RIXE	BR6HIX, BR7HIX, BR8HIX
RIZZATO	BR6HIX, BR8EIX
S.I.S.	BR6HIX, BR7HIX, BR8HIX



SACHS	BPR7HIX, BR6HIX, BR7HIX, BR8EIX, BR8HIX, BR9EIX
SAN YANG	BR8HIX
SANGLAS	BPR6EIX
SCORPA	BPR5EIX
SHERCO	BPR5EIX
SHERCO- HRD	BR8EIX
SIAMOTO	BPR6HIX
SIMONINI IMEA	BR8HIX
SIMSON	BR8HIX
SOLO	BR6HIX, BR7HIX
SPARTA	BR6HIX
STARFLITE	BR6HIX
SUZUKI	BPR6EIX, BPR6HIX, BPR7EIX, BPR7HIX, BR10EIX, BR7HIX, BR8EIX, BR8HIX, BR9EIX, CR10EIX, CR6HIX, CR7EIX, CR8EIX, CR9EIX, DPR7EIX-9, DPR8EIX-9, DPR9EIX-9, DR8EIX, DR9EIX
SWM	BPR5EIX
TESTI	BR6HIX, BR8EIX, BR8HIX
TGB	BPR7HIX
TITAN	BPR5EIX
TM	BR9EIX, CR8EIX
TOMOS	BR7HIX
TORROT	BR6HIX, BR7HIX
TRIUMPH	BR8EIX, CR9EIX, DPR8EIX-9
UNISOM	BR8HIX
URAL AMERICA	BPR7HIX
VELOSOLEX	BR6HIX
VERTEMATI	CR9EIX

XING FU	CR7HIX
YAMAHA	BPR6EIX, BPR6HIX, BPR7EIX, BPR7HIX, BPR8HIX, BR10EIX, BR6HIX, BR7HIX, BR8EIX, BR8HIX, BR9EIX, CR10EIX, CR6HIX, CR7EIX, CR7HIX, CR8EIX, CR9EIX, DPR7EIX-9, DPR8EIX-9, DPR9EIX-9, DR8EIX
ZID	BPR7HIX
ZÜNDAPP	BR8EIX, BR8HIX



APRILIA	BPR8HIX, BR7HIX, BR8HIX, BR9EIX, CR7EIX, CR8EIX, DR8EIX
ATALA	BPR6HIX, BR7HIX
BAJAJ	BPR6HIX, BR6HIX
BENELLI	BR6HIX, BR7HIX, BR8HIX, CR8EIX
BETA	BR7HIX, BR8HIX, DR8EIX
BMW	CR8EIX
BS VILLA	BR8HIX
BUFFALO	BR7HIX
CAGIVA	BPR6HIX, BR7HIX, BR8HIX, BR9EIX, CR7EIX
CCF	BPR7HIX
DAELIM	BR8HIX, CR8EIX-9
DERBI	BR10EIX, BR8HIX, BR9EIX, CR9EIX
ERING	BR6HIX, CR7HIX
FANTIC	BPR7HIX
GARELLI	BPR7HIX, BR10EIX, BR8HIX, CR7HIX
GILERA	BR9EIX, CR8EIX
HONDA	BPR6HIX, BR6HIX, BR8EIX, CR8EIX-9, DPR7EIX-9
HYOSUNG	BPR6HIX, BR8HIX, DR8EIX
ITALJET	BPR6HIX, BPR7HIX, BPR8HIX, BR7HIX, BR8HIX, BR9EIX, CR7EIX, CR8EIX, DR8EIX
KINETIC	BPR7HIX
KREIDLER	BPR7HIX, CR7HIX
KTM	BR7HIX
KYMCO	BR6HIX, BR8HIX, CR7HIX, CR8EIX, DPR7EIX-9, DR8EIX
K-ZWO	BR7HIX, CR7HIX
LECSON	BPR6HIX



LEM	BR7HIX
MACAL	BR7HIX
MALAGUTI	BPR6HIX, BR6HIX, BR7HIX, BR8HIX, CR7HIX, CR8EIX
MARS	BPR7HIX
MBK	BPR7HIX, BR7HIX, BR8HIX, CR7EIX, CR8EIX
MOTRON	BR7HIX
MZ	BR7HIX
PEGASUS	BPR7HIX, CR7HIX
PEUGEOT	BPR6HIX, BR7HIX, BR8EIX, BR8HIX, CR8EIX
PGO	BPR6HIX, BPR7HIX, CR7HIX
PIAGGIO	BR6HIX, BR7HIX, BR8EIX, BR9EIX, CR7EIX, CR8EIX, CR9EIX
REX	BPR7HIX, CR7HIX
RIEJU	BR8EIX, BR9EIX, CR7HIX
SACHS	BPR6HIX, BR7HIX, BR8HIX, CR7HIX
SAN YANG	BR8HIX, CR7HIX
SASY	BPR6HIX
SHE LUNG	BPR7HIX
SIAM	BPR6HIX
SIAMOTO	CR7HIX
SIMSON	BR8HIX
STEFFEN	BPR6HIX
SUNDIRO	CR7HIX
SUZUKI	BPR6HIX, BPR7HIX, CR7EIX, CR8EIX
SYM	BR8HIX, CR7HIX
T.G.M. Bimota	BPR6HIX
TGB	BPR6HIX

■ SERIES OF NGK RACING SPARK PLUGS

Blue colour indicates resistor plugs.

Thread size (Hexagon size)	Spark plug type	Spark plug number	Heat rating	Firing end appearance	Electrode material Center	Electrode material Ground
φ 14×19mm (20.8mm)	BP-E	R4304A-○	7.8,9,10	Ⓐ ①	Gold Palladium	Nickel Alloy
		R6918B-○	7.8,9	Ⓑ ①	Platinum	Nickel Alloy
		R6918C-○	9	Ⓑ ①	Platinum	Nickel Alloy
		R6021E-○	7.75,8,8.5,9,10,10.5	Ⓑ ①	Nickel Alloy	Nickel Alloy
		R6061-○	7.8,9,10,11	Ⓒ ①	Nickel Alloy	Nickel Alloy
		R6252E-○	9,10.5	Ⓒ ①	Nickel Alloy	Nickel Alloy
		R6252K-○	10.5	Ⓒ ①	Nickel Alloy	Nickel Alloy
		R6254E-○	9,10.5	Ⓒ ①	Nickel Alloy	Nickel Alloy
		R6254K-○	10.5	Ⓒ ①	Nickel Alloy	Nickel Alloy
		R7376-○	7.8,9,10	Ⓒ ①	Iridium	Platinum
		R5649-○	9,10,11	Ⓔ ①	Nickel Alloy	—
		R6712-○	9,10	Ⓔ ①	Nickel Alloy	—
φ 14×22mm (20.8mm)	Short	R6179A-○P	10,10.5,11	Ⓒ ②	Platinum	Platinum
		R6179C-○PA	10.5	Ⓒ ②	Platinum	Platinum
		R7376B-○	9,10	Ⓒ ①	Iridium	Platinum
		R7262A-○	10,10.5,11	Ⓒ ③	Iridium	Platinum
		R7262-○	7.8,9,10,10.5,11	Ⓒ ③	Iridium	Platinum
		R7262C-○	10.5,11	Ⓒ ③	Iridium	Platinum
φ 14×19mm (16.0mm)	Short	R7262M-○	10.5,11,11.5	Ⓒ ③	Iridium	Platinum
		R6888A-○	8.9,10	Ⓔ ②	Nickel Alloy	Nickel Alloy
		R7433-○	8.9,10	Ⓐ ⑤	Iridium	Nickel Alloy
		R7434-○	8.9,10	Ⓒ ⑤	Iridium	Platinum
		R7279-○	10	Ⓔ ⑤	Iridium	Platinum
		R6501-○	8.9,10,11	Ⓔ ⑤	Nickel Alloy	—
		R6711-○	9,10	Ⓔ ⑤	Nickel Alloy	—
		R7435-○	8.9,10	Ⓐ ④	Iridium	Nickel Alloy
		R7436-○	8.9,10	Ⓒ ④	Iridium	Platinum
		R5883-○	9,10,11	Ⓔ ④	Nickel Alloy	—
		R6690-○	9,10,11	Ⓔ ④	Nickel Alloy	—

Thread size (Hexagon size)	Spark plug type	Spark plug number	Heat rating	Firing end appearance	Electrode material	
					Center	Ground
φ 14X26.5mm (16.0mm)	LFR	R7437-○	8,9,10	(A) ①	Iridium	Nickel Alloy
		R7438-○	8,9,10	②	Iridium	Platinum
φ 14X12.7mm (20.8mm)	B-H	R5525-○	7,8,9,10,11	(B) ⑦	Gold Palladium	Nickel Alloy
		R5530-○	8,9,10,11	⑧	Gold Palladium	Platinum
φ 14X21.5mm (20.8mm)	Rotary Engine	R6725-○	9,10,105,11,115	(D) ⑤	Platinum	Platinum
	RX-7	R7420-○	9,10,105,11	(D) ⑥	Iridium	Platinum
φ 14X21mm (20.8mm)	Rotary Engine	R7440A-○L	9,10	③	Iridium	Platinum
	RX-8 L	R7440B-○T	10,11	④	Iridium	Platinum
φ 12X19mm (16.0mm)	DC-E	R2349-○	9,10,11	(E) ⑥	Nickel Alloy	—
		R2525-○	9,10,11	⑦	Platinum	Nickel Alloy
φ 10X19mm (16.0mm)	C-E	R0373A-○	9,10	③	Iridium	Platinum
		R0045G-○	10,11	(E) ⑧	Nickel Alloy	—
φ 10X19mm Half thread (16.0mm)	C-EH	R0409B-○	8,9,10	③	Iridium	Nickel Alloy
		R0161-○	9,10,11	(B) ⑩	Nickel Alloy	Nickel Alloy
		R847-○	10,11	(E) ⑪	Nickel Alloy	—

1) ISO: The length from gasket to terminal of ISO type spark plugs is 50.5mm which is 2.5mm shorter than BCP-E or BC-E type spark plugs.

2) Resistor spark plugs are recommended for cars originally equipped with resistor spark plugs.

When nonresistor spark plugs are installed in such cars, there is some possibility that the electric devices in the car, such as the audio system or the engine management system, would be affected by noise.

3) Marked * part number will be discontinued when the current stock is over.

APPEARANCE

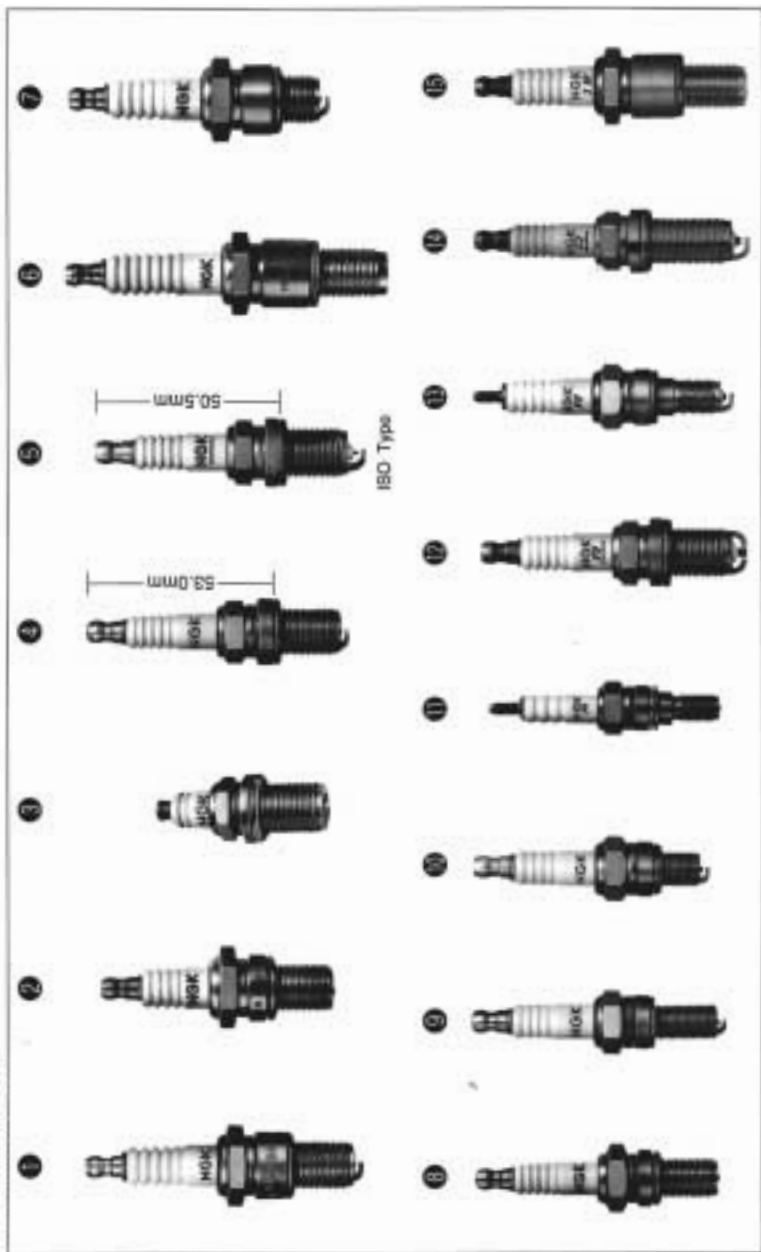

FIRING END



▲ Notice

• Choose appropriate heat range and firing end of racing spark plugs according to engine modification or driving condition.

(Generally, the more a firing position is projected into the combustion chamber, spark plug's ignitability is improved. However, a projected ground electrode tends to be exposed to high-temperature combustion gases and will possibly cause troubles because of over-heating. Therefore, when an engine is modified tougher, non-projected type spark plugs should be installed to keep the firing end's insulator and the ground electrode from exposed to high-temperature combustion gases. Also, colder type spark plugs should be chosen for high-modified engine.)

● DISCONTINUED PLUG TYPES

Old part number	New part number
R6255-○, R6255F-○, R6326-○	→ R7433-○
R6205-○, R6241-○	→ R7433-○
R6206-○, R6242-○	→ R7434-○
R5400-○, R5400F-○, R6337-○	→ R7435-○
R5688-○	→ R7435-○
R5930-○	→ R7436-○
R5687-○	→ R7436-○

Blue colour indicates resistor plugs.

Old part number	New part number
R6120-○	→ R7282-○
R6120A-○	→ R7282A-○
R6120C-○	→ R7282C-○
R6120M-○	→ R7282M-○
R4630A-○, R6385- P	→ R7376-○
R216-○, R217-○	→ R2525-○
R2270-○, R2430-○	→ R2349-○
R016-○, R017-○	→ R0373A-○

RECOMMENDATION CHART OF NGK RACING SPARK PLUGS

Notice

It is essential to use racing spark plugs that fit a specific engine and its conditions of use.



MOTORCYCLES

Blue colour indicates resistor plugs.

Manufacturer	Model	Spark plug Number	Racing spark plug IX, VX spark plug
HONDA	Road race		
	CB1300, X-4, CB1000SF	DPR8FA-9	R2525-10
	CBR1100XX, X11	CR9EIVX-9	R0045Q-10
	VTR1000SP-1	FR9BI-11	R7279-10
	VTR1000F-Line Storm	DPR9EVX-9	R2525-10
	CBR1000RR	R0409B-10	R0045Q-10
	CBR954RR(Fire Blade)	IMF9C-9H	R0045Q-10
	CBR900RR	CR9EH-9	R0045Q-10
	CBR600RR/F4i	IMF9C-9H	R0409B-10
	CBR400RR, CB400SF/R/S	CR8EH-9	R0409B-10
	NSR250R/SP/SE	BR9ECM	BR10ECMVX
	NSR80/50, NS-1	BR8ES	BR8EIX
	Z50J	CR6HSA	R0161-10, CR9HIX, CR8HIX
	RS250R	R6120-105	R7282-105, #R7282A-105
	NSR150	BR8ES, BR9ES	BR9EIX
	RS125R	R6385-105P	R7376-10, #R7282A-105
	NS50R	BR9ES	BR9EIX, R7282-10
	CRF450R	IFR8H11	R7433-8
	CRF250R	IMF8C-9H	-
	CR250R	BR8EG	BR8EIX, R7376-8
CR125R	BR9EG	BR9EIX, R7376-9	
CR90R/R2, CR85R/R2	BR10EG	BR10EIX, R7376-10	
TLM220R	BR8ES	BR8EIX	
TRIAL			
Road race	ZRX1100/11, ZX-8/R, ZX-12R	CR8E	R0373A-10
	ZX-10R	CR9E	R0373A-10, R0045Q-10
	GPZ200R	DR9EA	R2525-10
	NinjaZX-7RR	CR9E	R0045Q-10
	NinjaZX-6	CR9E	R0373A-10
	ZZ-R600/400	CR9E	R0373A-10
	ZXR400R, ZX-6R	CR9EK	R0373A-10

Manufacturer	Model	Spark plug Number	Racing spark plug IX, VX spark plug
KAWASAKI	Motocross	KLX300R, KLX250	CR8E
		KX250F	CR8E
		KX250	BR8EIX, R7376-8
		KX125	BR9EIX, R7376-9
		KX80V II, KX85/II	R6254K-105
		TL1000S/R	CR9E
		GSX1300R	CR9E
		GSX-R1000	CR9E
		GSX-R750/SP	R0373A-10, R0045Q-10
		GSX-R600, GSX-R400R	CR9E, CR8EK
SUZUKI	Road race	GSX400Impulse/S	CR8E
		RGV250Γ /SP, RGV125Γ	BR9ECM
		RM-Z250	CR8EB
		RM250	R69189-7
		RM125	R69189-8
		RM80L, RM95L	R69189-9
		YZF-R1/R6	CR8EX, CR10EK
		YZF-R7	CR9E
		YZF1000R	DR8EA
		TRX850, TM850	DPR8EA-9
YAMAHA	Road race	YZF750R/SP	CR9E
		YZF600R	CR9E
		FZR400RR-SP	CR8E
		TZR250SPR	BR8ECM
		TZR125	BR9EIX
		TZ250	R6179A-105P
		TZ125R	R6385-105P
		TZ50	BR9EY
		YZ450F, YZ426F, YZ400F	CR8E
		YZ250F	CR8E
DUCATI	Road race	YZ250	BR8EG
		YZ125	BR9EG
		YZ800LW, YZ850LW	BR10EG
		TY250Z	BR8EV
		996, 916	-

※ The thread length is longer than the normal type due to setting the detonation counter.